

2019 Karate BC Provincial Championships

2019.11.30 - 2019.12.01

CAN



KARATE BC



2019 Karate BC Provincial Championships - 2019-11-30

EK-10 Senior Male Kata

R1 G1/2 (2) Tatami 1 11:15

Competitors	Kata	1T	1A	2T	2A	3T	3A	4T	4A	5T	5A	6T	6A	7T	7A	TEC	ATH	Extra	Total Rank
1 WASADA SOTARO (KINGSWAY SHITO-RYU,CAN)	ANAN DAI	(7.8)	(8.0)	8.0	8.2	8.0	8.2	8.2	8.2	(8.6)	(8.6)					16.94	7.38		24.321
2 YAO EDWARD (KINGSWAY SHITO-RYU,CAN)	ANAN DAI	(8.0)	7.8	(7.6)	(7.6)	7.8	7.6	7.8	7.6	8.0	(8.4)					16.52	6.9		23.422

R1 G2/2 (2) Tatami 1 11:25

Competitors	Kata	1T	1A	2T	2A	3T	3A	4T	4A	5T	5A	6T	6A	7T	7A	TEC	ATH	Extra	Total Rank
1 MOVOLD ALEXANDER (NORTH WEST SHITO-KAI,CAN)	CHIBANA NO KUSHANKU	7.6	7.8	7.6	7.8	(8.6)	(8.6)	(7.4)	(7.4)	7.8	8.0					16.1	7.08		23.182
2 SAWAL JOHN (KINGSWAY SHITO-RYU,CAN)	OHAN	(7.2)	7.8	8.0	7.8	(8.4)	8.2	7.6	(7.6)	8.4	(8.4)					16.8	7.14		23.941

R2 Gold Medal Match Tatami 1 11:35

Competitors	Kata	1T	1A	2T	2A	3T	3A	4T	4A	5T	5A	6T	6A	7T	7A	TEC	ATH	Extra	Total Rank
1 SAWAL JOHN (KINGSWAY SHITO-RYU,CAN)	PAPUREN	(7.0)	8.2	8.0	(8.0)	(8.6)	8.2	8.2	8.2	8.6	(8.8)					17.36	7.38		24.742
2 WASADA SOTARO (KINGSWAY SHITO-RYU,CAN)	CHATANYARA KUSHANKU	8.6	8.0	8.4	8.6	8.2	8.6	(7.8)	(7.8)	(8.8)	(8.8)					17.64	7.56		25.2 1

Results

1	WASADA SOTARO	KINGSWAY SHITO-RYU		CANADA
2	SAWAL JOHN	KINGSWAY SHITO-RYU		CANADA
3	YAO EDWARD	KINGSWAY SHITO-RYU		CANADA
3	MOVOLD ALEXANDER	NORTH WEST SHITO-KAI		CANADA



2019 Karate BC Provincial Championships - 2019-11-30

EK-1 Female Youth (12/13) Kata

KARATE BC

EK-1 Female Youth (12/13) Kata R1 G1/2 (3) Tatami 1 09:00

Competitors	Kata	1T	1A	2T	2A	3T	3A	4T	4A	5T	5A	6T	6A	7T	7A	TEC	ATH	Extra	Total Rank
1 SCARISBRICK MORGAN (SHIMA KARATE SCHOOL - NANAIMO,CAN)	SEPAI	(7.6)	(7.6)	7.2	(7.2)	7.6	7.4	7.4	7.6	(6.6)	7.2					15.54	6.66		22.2 2
2 RATTI SHALIN (WEST RIVER,CAN)	ANAN	8.2	(8.2)	(7.6)	(7.6)	8.0	7.8	7.8	8.2	(8.4)	8.2					16.8	7.26		24.06 1
3 ZHONG YI (BURNABY MOUNTAIN KARATE,CAN)	NIPAPO	6.8	6.6	6.8	6.8	(7.6)	(7.4)	6.8	7.0	(6.0)	(6.2)					14.28	6.12		20.4 3

EK-1 Female Youth (12/13) Kata R1 G2/2 (3) Tatami 1 09:15

Competitors	Kata	1T	1A	2T	2A	3T	3A	4T	4A	5T	5A	6T	6A	7T	7A	TEC	ATH	Extra	Total Rank
1 STEWART KEELI (NORTH WEST SHITO-KAI,CAN)	UNSHU	(7.0)	(6.8)	7.2	7.2	(7.8)	(8.0)	7.6	7.0	7.6	7.6					15.68	6.54		22.22 3
2 CASACLANG ABIGAIL (KINGSWAY SHITO-RYU,CAN)	KUSANKU	(6.8)	(6.6)	7.6	7.0	(8.4)	(8.6)	7.4	6.8	7.8	7.2					15.96	6.3		22.26 2
3 DEAL AZIA (SHIMA KARATE SCHOOL - NANAIMO,CAN)	KUSANKU	7.4	(7.4)	7.4	7.4	(8.8)	(8.8)	(6.8)	7.4	7.8	7.6					15.82	6.72		22.54 1

EK-1 Female Youth (12/13) Kata R2 Bronze Medal Match 1 Tatami 1 09:30

Competitors	Kata	1T	1A	2T	2A	3T	3A	4T	4A	5T	5A	6T	6A	7T	7A	TEC	ATH	Extra	Total Rank
1 SCARISBRICK MORGAN (SHIMA KARATE SCHOOL - NANAIMO,CAN)	SUPARINPAI	7.0	7.0	7.2	(7.2)	(7.4)	7.2	6.8	7.0	(6.2)	(6.8)					14.7	6.36		21.06 2
2 STEWART KEELI (NORTH WEST SHITO-KAI,CAN)	MATSUMURA ROHAI	7.4	(7.4)	(6.8)	7.4	(8.2)	(8.4)	7.2	7.4	7.6	7.4					15.54	6.66		22.2 1

EK-1 Female Youth (12/13) Kata R2 Bronze Medal Match 2 Tatami 1 09:40

Competitors	Kata	1T	1A	2T	2A	3T	3A	4T	4A	5T	5A	6T	6A	7T	7A	TEC	ATH	Extra	Total Rank
1 ZHONG YI (BURNABY MOUNTAIN KARATE,CAN)	BASSAI DAI	6.8	6.6	6.4	6.2	(7.8)	(7.4)	6.8	7.0	(6.0)	(5.8)					14.0	5.94		19.94 2
2 CASACLANG ABIGAIL (KINGSWAY SHITO-RYU,CAN)	KOSUKUN SHO	(7.2)	(7.0)	7.4	7.2	(8.2)	(8.4)	7.4	7.0	7.8	7.6					15.82	6.54		22.36 1

EK-1 Female Youth (12/13) Kata R2 Gold Medal Match Tatami 1 09:50

Competitors	Kata	1T	1A	2T	2A	3T	3A	4T	4A	5T	5A	6T	6A	7T	7A	TEC	ATH	Extra	Total Rank
1 DEAL AZIA (SHIMA KARATE SCHOOL - NANAIMO,CAN)	SUPARINPAI	7.4	7.4	7.2	(7.2)	(8.4)	(8.2)	(6.8)	7.2	7.0	7.4					15.12	6.6		21.72 2
2 RATTI SHALIN (WEST RIVER,CAN)	NIPAPO	8.2	(8.2)	(7.0)	(7.4)	7.6	7.6	(8.6)	8.0	7.8	8.0					16.52	7.08		23.6 1

Results

1	RATTI SHALIN	WEST RIVER		CANADA
2	DEAL AZIA	SHIMA KARATE SCHOOL - NANAIMO		CANADA
3	STEWART KEELI	NORTH WEST SHITO-KAI		CANADA
3	CASACLANG ABIGAIL	KINGSWAY SHITO-RYU		CANADA



2019 Karate BC Provincial Championships - 2019-11-30

EK-2 Female Cadet (14/15) Kata

KARATE BC

EK-2 Female Cadet (14/15) Kata R1 G1/2 (5) Tatami 1 10:00

Competitors	Kata	1T	1A	2T	2A	3T	3A	4T	4A	5T	5A	6T	6A	7T	7A	TEC	ATH	Extra	Total Rank
1 ARNOTT BROOKE (ASHCROFT KARATE CLUB,CAN)	KANKU DAI	6.4	6.4	(6.0)	(6.0)	(7.0)	(6.8)	6.2	6.2	6.0	6.4					13.02	5.7		18.725
2 LEE SONJA (WEST RIVER,CAN)	ANAN	(7.4)	7.4	7.4	(7.2)	8.0	(8.2)	7.6	7.6	(8.4)	8.0					16.1	6.9		23.0 3
3 BRODIE OLIVIA (VARSITY PERFORMANCE KARATE CLUB,CAN)	CHATANYARA KUSHANKU	(7.2)	(7.2)	7.8	7.6	(8.4)	(8.6)	8.2	8.4	8.2	8.2					16.94	7.26		24.2 2
4 GAMBOA OONAH (KINGSWAY SHITO-RYU,CAN)	CHATANYARA KUSHANKU	8.4	8.4	(8.0)	(8.0)	(8.8)	8.8	8.8	8.6	8.8	(9.0)					18.2	7.74		25.941
5 VILLAMENTE NINA (WEST RIVER,CAN)	NIPAPO	7.0	(7.0)	(6.8)	7.0	(8.0)	(8.0)	7.4	7.6	7.2	7.0					15.12	6.48		21.6 4

EK-2 Female Cadet (14/15) Kata R1 G2/2 (4) Tatami 1 10:25

Competitors	Kata	1T	1A	2T	2A	3T	3A	4T	4A	5T	5A	6T	6A	7T	7A	TEC	ATH	Extra	Total Rank
1 DAVISON FAITH (KENZEN SPORTS KARATE,CAN)	NIPAPO	(6.8)	6.8	(7.4)	(7.4)	6.8	(6.6)	6.8	7.2	7.0	6.8					14.42	6.24		20.664
2 CROWLE ELLA (VARSITY PERFORMANCE KARATE CLUB,CAN)	NIPAPO	(7.2)	(7.2)	7.0	7.0	7.0	(6.8)	7.0	7.0	(6.6)	6.8					14.7	6.24		20.943
3 SCOTT JENNA (NORTH WEST SHITO-KAI,CAN)	ANAN	7.8	7.8	7.8	7.8	(8.2)	8.4	8.0	(8.6)	(7.4)	(7.6)					16.52	7.2		23.721
4 LIANG MEGAN (WEST RIVER,CAN)	NIPAPO	(7.4)	(7.2)	7.6	7.2	(8.6)	(8.2)	8.4	7.8	7.4	7.4					16.38	6.72		23.1 2

EK-2 Female Cadet (14/15) Kata R2 Bronze Medal Match 1 Tatami 1 10:45

Competitors	Kata	1T	1A	2T	2A	3T	3A	4T	4A	5T	5A	6T	6A	7T	7A	TEC	ATH	Extra	Total Rank
1 CROWLE ELLA (VARSITY PERFORMANCE KARATE CLUB,CAN)	ANAN	7.2	7.2	(6.8)	(6.8)	(7.8)	(7.6)	6.8	6.8	7.2	7.2					14.84	6.36		21.2 2
2 BRODIE OLIVIA (VARSITY PERFORMANCE KARATE CLUB,CAN)	NIPAPO	(7.4)	(7.4)	7.6	7.8	(8.6)	(8.4)	8.4	8.2	8.0	8.0					16.8	7.2		24.0 1

EK-2 Female Cadet (14/15) Kata R2 Bronze Medal Match 2 Tatami 1 10:55

Competitors	Kata	1T	1A	2T	2A	3T	3A	4T	4A	5T	5A	6T	6A	7T	7A	TEC	ATH	Extra	Total Rank
1 LEE SONJA (WEST RIVER,CAN)	PAIKU	(7.2)	(7.2)	7.4	7.2	(8.2)	(8.0)	7.6	7.4	8.0	7.8					16.1	6.72		22.822
2 LIANG MEGAN (WEST RIVER,CAN)	ANAN	7.4	7.4	(7.0)	(6.8)	7.8	7.8	(8.2)	7.8	8.2	(8.0)					16.38	6.9		23.281

EK-2 Female Cadet (14/15) Kata R2 Gold Medal Match Tatami 1 11:05

Competitors	Kata	1T	1A	2T	2A	3T	3A	4T	4A	5T	5A	6T	6A	7T	7A	TEC	ATH	Extra	Total Rank
1 SCOTT JENNA (NORTH WEST SHITO-KAI,CAN)	ANAN DAI	8.2	8.2	(7.6)	(7.8)	(8.4)	(8.6)	7.8	8.4	8.2	8.4					16.94	7.5		24.442
2 GAMBOA OONAH (KINGSWAY SHITO-RYU,CAN)	ANAN DAI	8.4	8.4	(8.0)	(8.2)	8.8	8.8	8.8	8.6	(9.0)	(9.0)					18.2	7.74		25.941

Results

1	GAMBOA OONAH	KINGSWAY SHITO-RYU		CANADA
2	SCOTT JENNA	NORTH WEST SHITO-KAI		CANADA
3	BRODIE OLIVIA	VARSITY PERFORMANCE KARATE CLUB		CANADA
3	LIANG MEGAN	WEST RIVER		CANADA



2019 Karate BC Provincial Championships - 2019-11-30

EK-3 Female Junior (16/17) Kata

KARATE BC

EK-3 Female Junior (16/17) Kata R1 G1/2 (3) Tatami 4 10:10

Competitors	Kata	1T	1A	2T	2A	3T	3A	4T	4A	5T	5A	6T	6A	7T	7A	TEC	ATH	Extra	Total Rank
1 DEL_ROSARIO AMELIE (KINGSWAY SHITO-RYU,CAN)	PAPUREN	8.2	8.0	(7.4)	(7.6)	8.4	8.2	(8.6)	8.4	8.6	(8.8)	(5.0)	(5.0)	(10.0)	(10.0)	17.64	7.38		25.021
2 GRAFF ALEXANDRA (BURNABY CHITO RYU YUSEIKAN,CAN)	SANSEIRU	7.8	7.6	(7.2)	(7.2)	7.8	8.0	7.8	(8.2)	(8.0)	7.8	(5.0)	(5.0)	(10.0)	(10.0)	16.38	7.02		23.4 2
3 LEE KIRSTEN (WEST RIVER,CAN)	SUPARINPAI	(6.8)	(6.8)	7.0	7.0	(7.6)	(8.0)	7.6	7.6	7.2	6.8	(5.0)	(5.0)	(10.0)	(10.0)	15.26	6.42		21.683

EK-3 Female Junior (16/17) Kata R1 G2/2 (3) Tatami 4 10:25

Competitors	Kata	1T	1A	2T	2A	3T	3A	4T	4A	5T	5A	6T	6A	7T	7A	TEC	ATH	Extra	Total Rank
1 WIENS CHEYENNE (ASHCROFT KARATE CLUB,CAN)	KANKU DAI	6.4	(6.6)	6.4	6.4	(6.6)	6.4	6.6	6.6	(6.0)	(5.8)	(5.0)	(5.0)	(10.0)	(10.0)	13.58	5.82		19.4 3
2 NG ASHLYN (VANCOUVER SATO-HA SHITO-RYU,CAN)	NIPAPO	7.8	7.6	(6.8)	(7.2)	7.8	7.6	(8.2)	(8.0)	8.0	7.6	(5.0)	(5.0)	(10.0)	(10.0)	16.52	6.84		23.361
3 MORI YUKI (STEVESTON KARATE CLUB,CAN)	CHIBANA NO KUSHANKU	7.2	(7.2)	(6.6)	7.2	8.2	7.8	(8.4)	(8.9)	8.2	7.4	(5.0)	(5.0)	(10.0)	(10.0)	16.52	6.72		23.242

EK-3 Female Junior (16/17) Kata R2 Bronze Medal Match 1 Tatami 4 10:40

Competitors	Kata	1T	1A	2T	2A	3T	3A	4T	4A	5T	5A	6T	6A	7T	7A	TEC	ATH	Extra	Total Rank
1 WIENS CHEYENNE (ASHCROFT KARATE CLUB,CAN)	JION	(6.6)	(6.8)	6.4	6.4	6.6	6.2	6.4	6.6	(6.0)	(5.8)	(5.0)	(5.0)	(10.0)	(10.0)	13.58	5.76		19.342
2 GRAFF ALEXANDRA (BURNABY CHITO RYU YUSEIKAN,CAN)	CHINTO	7.2	(6.8)	(7.0)	7.2	8.0	8.0	(8.6)	(8.6)	7.8	8.0	(5.0)	(5.0)	(10.0)	(10.0)	16.1	6.96		23.061

EK-3 Female Junior (16/17) Kata R2 Bronze Medal Match 2 Tatami 4 10:50

Competitors	Kata	1T	1A	2T	2A	3T	3A	4T	4A	5T	5A	6T	6A	7T	7A	TEC	ATH	Extra	Total Rank
1 LEE KIRSTEN (WEST RIVER,CAN)	TOMARI BASSAI	(7.0)	(7.0)	7.2	7.2	7.6	(7.6)	(8.0)	7.6	7.4	7.0	(5.0)	(5.0)	(10.0)	(10.0)	15.54	6.54		22.082
2 MORI YUKI (STEVESTON KARATE CLUB,CAN)	CHATANYARA KUSHANKU	(6.8)	(6.8)	7.8	7.8	8.0	8.2	(8.4)	(8.4)	7.8	7.4	(5.0)	(5.0)	(10.0)	(10.0)	16.52	7.02		23.541

EK-3 Female Junior (16/17) Kata R2 Gold Medal Match Tatami 4 11:00

Competitors	Kata	1T	1A	2T	2A	3T	3A	4T	4A	5T	5A	6T	6A	7T	7A	TEC	ATH	Extra	Total Rank
1 NG ASHLYN (VANCOUVER SATO-HA SHITO-RYU,CAN)	ANAN	7.8	8.2	(7.6)	(7.6)	8.0	8.2	(8.4)	(8.4)	8.2	7.6	(5.0)	(5.0)	(10.0)	(10.0)	16.8	7.2		24.0 2
2 DEL_ROSARIO AMELIE (KINGSWAY SHITO-RYU,CAN)	SUPARINPAI	(7.4)	(6.8)	8.0	8.0	8.2	7.8	(8.8)	(8.8)	8.6	8.4	(5.0)	(5.0)	(10.0)	(10.0)	17.36	7.26		24.621

Results

1	DEL ROSARIO AMELIE	KINGSWAY SHITO-RYU		CANADA
2	NG ASHLYN	VANCOUVER SATO-HA SHITO-RYU		CANADA
3	GRAFF ALEXANDRA	BURNABY CHITO RYU YUSEIKAN		CANADA
3	MORI YUKI	STEVESTON KARATE CLUB		CANADA



2019 Karate BC Provincial Championships - 2019-11-30

EK-4 Female U21 Kata

R1 G1/1 (1)

	Competitors	Kata	1 T	1 A	2 T	2 A	3 T	3 A	4 T	4 A	5 T	5 A	6 T	6 A	7 T	7 A	TEC	ATH	Extra	Total	Rank	
1	SPUR BRYANA (WEST RIVER,CAN)																					

Results

1	SPUR BRYANA	WEST RIVER		CANADA
---	-------------	------------	---	--------



2019 Karate BC Provincial Championships - 2019-11-30

EK-5 Senior Female Kata

R1 G1/1 (2) Tatami 4 11:10

Competitors	Kata	1 T	1 A	2 T	2 A	3 T	3 A	4 T	4 A	5 T	5 A	6 T	6 A	7 T	7 A	TEC	ATH	Extra	Total	Rank
1 DEL ROSARIO AMELIE (KINGSWAY SHITO-RYU,CAN)	SUPARINPAI	8.0	8.0	(7.8)	(7.4)	8.2	8.0	(8.6)	8.4	8.4	(8.8)					17.22	7.32		24.54	2
2 LAOS-LOO CLAUDIA (NIKKEI KARATE,CAN)	PAPUREN	(8.6)	(8.6)	8.6	8.6	8.6	(8.0)	8.4	8.2	(8.2)	8.4					17.92	7.56		25.48	1

Results

1	LAOS-LOO CLAUDIA	NIKKEI KARATE		CANADA
2	DEL ROSARIO AMELIE	KINGSWAY SHITO-RYU		CANADA

**KARATE BC**

2019 Karate BC Provincial Championships - 2019-11-30

EK-6 Male Youth (12/13) Kata

EK-6 Male Youth (12/13) Kata R1 G1/2 (6) Tatami 2 09:00

Competitors	Kata	1T	1A	2T	2A	3T	3A	4T	4A	5T	5A	6T	6A	7T	7A	TEC	ATH	Extra	Total Rank
1 TAKENAKA YUTA (KINGSWAY SHITO-RYU,CAN)	KOSUKUN DAI	7.4	(7.2)	(6.6)	(6.4)	7.0	7.0	(7.8)	7.2	7.8	6.8					15.54	6.3		21.843
2 IZEN OLIVER (WEST RIVER,CAN)	ANAN	(7.0)	(7.0)	7.6	7.0	7.4	7.4	(8.4)	(8.2)	7.2	7.2					15.54	6.48		22.022
3 HOPEWELL OWEN (SHIMA KARATE SCHOOL - NANAIMO,CAN)	SEPAI	7.6	7.6	7.4	(7.2)	7.6	7.4	(7.8)	(7.8)	(7.0)	7.6					15.82	6.78		22.6 1
4 TAMAGI DEREK (NIKKEI KARATE,CAN)	BASSAI DAI	6.8	7.0	(6.4)	(6.4)	(7.0)	(7.2)	6.8	7.0	6.8	7.0					14.28	6.3		20.585
5 NEUFELD ISAAC (BURNABY CHITO RYU YUSEIKAN,CAN)	SEISAN	(7.0)	(6.8)	(6.2)	(6.0)	6.8	6.8	7.0	6.6	7.0	6.8					14.56	6.06		20.624
6 NGUYEN MARCUS (SHIMA KARATE SCHOOL - NANAIMO,CAN)	SEPAI	6.8	6.6	(5.8)	(5.6)	(7.0)	(6.8)	6.2	6.6	6.6	6.6					13.72	5.94		19.666

EK-6 Male Youth (12/13) Kata R1 G2/2 (6) Tatami 3 09:00

Competitors	Kata	1T	1A	2T	2A	3T	3A	4T	4A	5T	5A	6T	6A	7T	7A	TEC	ATH	Extra	Total Rank
1 VILLAMENTE NEILL (WEST RIVER,CAN)	NIPAPO	(7.2)	(7.0)	7.0	7.4	7.2	(6.8)	(8.1)	8.3	7.2	7.4	(5.0)	(10.0)	(5.0)	(10.0)	14.98	6.93		21.913
2 CLARK EMMY (NORTH WEST SHITO-KAI,CAN)	KOSUKUN DAI	6.4	(6.4)	6.6	7.0	6.6	(6.4)	(7.8)	7.7	(7.0)	7.0	(5.0)	(10.0)	(5.0)	(10.0)	13.72	6.51		20.235
3 MORI HARUKI (STEVESON KARATE CLUB,CAN)	CHATANYARA KUSHANKU	7.6	(7.6)	7.6	(7.8)	(8.2)	8.6	8.0	8.1	(8.2)	8.0	(5.0)	(10.0)	(5.0)	(10.0)	16.24	7.41		23.651
4 REMEDIOS NATHAN (WEST RIVER,CAN)	UNSU	7.1	7.1	6.8	(7.0)	6.8	(7.0)	(7.7)	7.9	(7.4)	7.6	(5.0)	(10.0)	(5.0)	(10.0)	14.49	6.78		21.274
5 HILDERLEY OLIVER (SHIMA KARATE SCHOOL - NANAIMO,CAN)	CHATANYARA KUSHANKU	6.4	(6.4)	(6.6)	6.6	6.6	(6.2)	6.2	6.4	(7.0)	7.2	(5.0)	(10.0)	(5.0)	(10.0)	13.44	6.06		19.5 6
6 NG NATHAN (VANCOUVER SATO-HA SHITO-RYU,CAN)	SOCHIN	7.4	(7.4)	7.4	(7.4)	(8.0)	7.8	(7.8)	7.9	7.6	7.6	(5.0)	(10.0)	(5.0)	(10.0)	15.68	6.99		22.672

EK-6 Male Youth (12/13) Kata R2-G1 Tatami 2 09:30

Competitors	Kata	1T	1A	2T	2A	3T	3A	4T	4A	5T	5A	6T	6A	7T	7A	TEC	ATH	Extra	Total Rank
1 NEUFELD ISAAC (BURNABY CHITO RYU YUSEIKAN,CAN)	NISEISHI	(7.0)	(6.8)	7.0	7.0	(7.4)	(7.4)	7.0	6.8	7.0	6.8					14.7	6.18		20.884
2 TAKENAKA YUTA (KINGSWAY SHITO-RYU,CAN)	PAIKU	(8.2)	(8.0)	7.6	7.4	7.8	7.8	8.0	7.6	(7.0)	(7.0)					16.38	6.84		23.221
3 IZEN OLIVER (WEST RIVER,CAN)	NIPAPO	7.8	7.6	(7.4)	(7.4)	7.4	(8.0)	(8.4)	8.0	7.4	7.4					15.82	6.9		22.722
4 HOPEWELL OWEN (SHIMA KARATE SCHOOL - NANAIMO,CAN)	SUPARINPAI	(7.2)	(7.8)	(7.8)	7.6	7.2	(7.2)	7.8	7.6	7.6	7.4					15.82	6.78		22.6 3

EK-6 Male Youth (12/13) Kata R2-G2 Tatami 3 09:30

Competitors	Kata	1T	1A	2T	2A	3T	3A	4T	4A	5T	5A	6T	6A	7T	7A	TEC	ATH	Extra	Total Rank
1 REMEDIOS NATHAN (WEST RIVER,CAN)	GOJUSHIHO	(7.6)	7.4	7.2	(7.2)	6.6	(6.6)	(7.8)	7.8	7.6	7.6	(5.0)	(10.0)	(5.0)	(10.0)	14.98	6.84		21.823
2 VILLAMENTE NEILL (WEST RIVER,CAN)	ANAN	7.0	(6.8)	6.8	(6.8)	(7.4)	7.0	7.2	7.6	(8.0)	7.8	(5.0)	(10.0)	(5.0)	(10.0)	14.7	6.72		21.424
3 NG NATHAN (VANCOUVER SATO-HA SHITO-RYU,CAN)	BASSAI DAI	6.8	(7.0)	7.6	(7.6)	(8.6)	8.8	8.0	8.2	(8.2)	8.2	(5.0)	(10.0)	(5.0)	(10.0)	15.68	7.56		23.242
4 MORI HARUKI (STEVESON KARATE CLUB,CAN)	ANAN DAI	8.2	(8.2)	7.8	(7.8)	(8.8)	9.0	(8.6)	8.6	8.6	8.4	(5.0)	(10.0)	(5.0)	(10.0)	17.22	7.8		25.021

EK-6 Male Youth (12/13) Kata R3 Bronze Medal Match 1 Tatami 2 09:50

Competitors	Kata	1T	1A	2T	2A	3T	3A	4T	4A	5T	5A	6T	6A	7T	7A	TEC	ATH	Extra	Total Rank
1 REMEDIOS NATHAN (WEST RIVER,CAN)	PAIKU	(7.8)	(7.6)	7.6	7.6	6.8	(6.6)	(8.0)	8.2	7.6	7.6	(5.0)	(10.0)	(5.0)	(10.0)	15.4	7.02		22.422
2 IZEN OLIVER (WEST RIVER,CAN)	HEIKU	7.6	7.6	(8.0)	(7.4)	(8.2)	8.4	8.0	8.2	7.4	(7.4)	(5.0)	(10.0)	(5.0)	(10.0)	16.1	7.26		23.361

EK-6 Male Youth (12/13) Kata R3 Bronze Medal Match 2 Tatami 3 09:50

Competitors	Kata	1T	1A	2T	2A	3T	3A	4T	4A	5T	5A	6T	6A	7T	7A	TEC	ATH	Extra	Total Rank
1 HOPEWELL OWEN (SHIMA KARATE SCHOOL - NANAIMO,CAN)	ANAN	(7.0)	(7.0)	7.2	7.6	7.4	7.4	7.4	7.6	(8.0)	(8.4)					15.4	6.78		22.182
2 NG NATHAN (VANCOUVER SATO-HA SHITO-RYU,CAN)	TOMARI BASSAI	(7.6)	(7.4)	7.6	7.8	7.8	7.8	7.8	8.0	(8.4)	(8.6)					16.24	7.08		23.321

EK-6 Male Youth (12/13) Kata R3 Gold Medal Match Tatami 2 10:00

Competitors	Kata	1T	1A	2T	2A	3T	3A	4T	4A	5T	5A	6T	6A	7T	7A	TEC	ATH	Extra	Total Rank
1 TAKENAKA YUTA (KINGSWAY SHITO-RYU,CAN)	PACHU	(8.2)	8.2	7.8	(7.6)	7.4	(7.4)	8.0	8.2	(8.4)	8.2	(5.0)	(10.0)	(5.0)	(10.0)	16.24	7.38		23.622
2 MORI HARUKI (STEVESON KARATE CLUB,CAN)	SUPARINPAI	8.4	8.4	8.0	(8.0)	7.8	(8.0)	(8.6)	8.4	(8.8)	8.8	(5.0)	(10.0)	(5.0)	(10.0)	16.94	7.68		24.621

Results



1	MORI HARUKI	STEVESON KARATE CLUB		CANADA
2	TAKENAKA YUTA	KINGSWAY SHITO-RYU		CANADA



2019 Karate BC Provincial Championships - 2019-11-30

EK-6 Male Youth (12/13) Kata

KARATE BC

3	IZEN OLIVER	WEST RIVER		CANADA
3	NG NATHAN	VANCOUVER SATO-HA SHITO-RYU		CANADA



KARATE BC

2019 Karate BC Provincial Championships - 2019-11-30

EK-7 Male Cadet (14/15) Kata

EK-7 Male Cadet (14/15) Kata R1 G1/2 (6) Tatami 2 10:10

Competitors	Kata	1T	1A	2T	2A	3T	3A	4T	4A	5T	5A	6T	6A	7T	7A	TEC	ATH	Extra	Total Rank
1 BAERG DAMON (SHIMA KARATE SCHOOL - NANAIMO,CAN)	CHATANYARA KUSHANKU	7.0	7.0	7.4	7.2	7.2	7.4	(7.6)	(7.6)	(6.4)	(6.0)					15.12	6.48		21.6 5
2 SPUR BRAYDEN (WEST RIVER,CAN)	PAIKU	(7.6)	(7.8)	(8.6)	8.4	7.8	7.8	7.8	7.8	8.4	(9.0)					16.8	7.2		24.0 3
3 TAMAGI DEREK (NIKKEI KARATE,CAN)	ROHAI	6.8	6.8	(8.0)	(7.4)	7.0	6.8	6.8	7.2	(6.2)	(6.0)					14.42	6.24		20.666
4 NAKAJIMA KAICHI (WEST RIVER,CAN)	CHATANYARA KUSHANKU	8.0	(8.0)	(8.8)	(9.0)	8.0	8.0	(7.8)	8.2	8.8	9.0					17.36	7.56		24.921
5 MORI HARUKI (STEVESTON KARATE CLUB,CAN)	CHIBANA NO KUSHANKU	8.2	8.4	8.2	8.4	(8.0)	(7.8)	8.0	8.4	(9.2)	(9.4)					17.08	7.56		24.642
6 FIELD NOLAN (NORTH WEST SHITO-KAI,CAN)	ANAN DAI	7.4	(7.4)	(7.8)	(7.8)	(7.2)	7.4	7.2	7.4	7.6	7.4					15.54	6.66		22.2 4

EK-7 Male Cadet (14/15) Kata R1 G2/2 (6) Tatami 3 10:05

Competitors	Kata	1T	1A	2T	2A	3T	3A	4T	4A	5T	5A	6T	6A	7T	7A	TEC	ATH	Extra	Total Rank
1 BAYBEN THEODORE (KINGSWAY SHITO-RYU,CAN)	KOSUKUN SHO	(7.2)	(7.4)	(6.8)	(6.8)	6.8	7.0	6.8	7.0	7.2	7.0					14.56	6.3		20.864
2 IZEN SPENCER (WEST RIVER,CAN)	ANAN	(7.6)	7.6	(7.0)	(7.0)	7.0	7.2	7.0	7.2	7.6	(7.8)					15.12	6.6		21.723
3 ANANDKUMAR VIKRANT (STEVESTON KARATE CLUB,CAN)	CHIBANA NO KUSHANKU	8.0	(8.0)	(8.4)	8.4	8.0	8.2	(7.8)	8.0	8.4	(8.8)					17.08	7.38		24.461
4 WELCH ADAM (SHIMA KARATE SCHOOL - NANAIMO,CAN)	SEISAN	(7.0)	(7.2)	6.4	(6.0)	6.6	6.8	6.8	6.8	(6.2)	6.0					13.86	5.88		19.746
5 VERHULST NATHAN (WEST RIVER,CAN)	ANAN	(7.8)	(7.8)	(7.2)	(7.0)	7.4	7.6	7.4	7.2	7.6	7.4					15.68	6.66		22.342
6 HOWARD KENTAROU (BURNABY CHITO RYU YUSEIKAN,CAN)	SEISAN	6.8	6.6	7.0	7.0	(6.0)	(6.2)	(7.2)	(7.2)	6.8	6.8					14.42	6.12		20.545

EK-7 Male Cadet (14/15) Kata R2-G1 Tatami 2 10:45

Competitors	Kata	1T	1A	2T	2A	3T	3A	4T	4A	5T	5A	6T	6A	7T	7A	TEC	ATH	Extra	Total Rank
1 FIELD NOLAN (NORTH WEST SHITO-KAI,CAN)	PAIKU	(7.2)	7.2	7.0	7.0	7.0	7.2	7.2	(7.4)	(6.8)	(6.6)					14.84	6.42		21.264
2 SPUR BRAYDEN (WEST RIVER,CAN)	CHATANYARA KUSHANKU	(7.6)	(7.6)	7.8	7.6	(8.0)	(8.2)	7.8	8.0	7.8	8.0					16.38	7.08		23.463
3 MORI HARUKI (STEVESTON KARATE CLUB,CAN)	ANAN DAI	(8.0)	(7.8)	8.0	7.8	(8.2)	(8.6)	8.0	8.2	8.2	8.0					16.94	7.2		24.142
4 NAKAJIMA KAICHI (WEST RIVER,CAN)	SUPARINPAI	(7.6)	8.2	8.2	(8.0)	(8.4)	(8.6)	8.2	8.4	8.2	8.0					17.22	7.38		24.6 1

EK-7 Male Cadet (14/15) Kata R2-G2 Tatami 3 10:35

Competitors	Kata	1T	1A	2T	2A	3T	3A	4T	4A	5T	5A	6T	6A	7T	7A	TEC	ATH	Extra	Total Rank
1 BAYBEN THEODORE (KINGSWAY SHITO-RYU,CAN)	NIPAPO	7.0	(7.0)	7.0	7.0	(6.8)	7.0	(7.2)	7.0	7.2	(7.2)					14.84	6.3		21.144
2 IZEN SPENCER (WEST RIVER,CAN)	NIPAPO	(7.4)	7.4	7.2	(7.0)	7.2	7.4	(6.8)	7.0	7.4	(7.6)					15.26	6.54		21.8 3
3 VERHULST NATHAN (WEST RIVER,CAN)	SUPARINPAI	7.6	(7.8)	(7.8)	7.8	(7.4)	7.6	7.4	(7.2)	7.6	7.6					15.82	6.9		22.722
4 ANANDKUMAR VIKRANT (STEVESTON KARATE CLUB,CAN)	CHATANYARA KUSHANKU	8.2	8.2	8.0	8.0	(8.4)	(8.4)	8.0	(7.8)	(7.6)	8.0					16.94	7.26		24.2 1

EK-7 Male Cadet (14/15) Kata R3 Bronze Medal Match 1 Tatami 3 10:55

Competitors	Kata	1T	1A	2T	2A	3T	3A	4T	4A	5T	5A	6T	6A	7T	7A	TEC	ATH	Extra	Total Rank
1 IZEN SPENCER (WEST RIVER,CAN)	PAIKU	7.4	7.2	(7.8)	(7.6)	(7.0)	7.2	7.4	(7.0)	7.2	7.2					15.4	6.48		21.882
2 MORI HARUKI (STEVESTON KARATE CLUB,CAN)	SUPARINPAI	7.6	(7.4)	(8.0)	7.8	8.0	(8.2)	8.0	8.0	(7.4)	7.6					16.52	7.02		23.541

EK-7 Male Cadet (14/15) Kata R3 Bronze Medal Match 2 Tatami 2 11:05

Competitors	Kata	1T	1A	2T	2A	3T	3A	4T	4A	5T	5A	6T	6A	7T	7A	TEC	ATH	Extra	Total Rank
1 VERHULST NATHAN (WEST RIVER,CAN)	CHATANYARA KUSHANKU	(7.2)	(6.8)	(7.4)	(7.2)	7.2	6.8	7.2	6.8	7.2	7.2					15.12	6.24		21.362
2 SPUR BRAYDEN (WEST RIVER,CAN)	SUPARINPAI	7.6	(7.4)	7.6	(7.6)	7.6	7.6	(7.8)	7.6	(7.4)	7.4					15.96	6.78		22.741

EK-7 Male Cadet (14/15) Kata R3 Gold Medal Match Tatami 3 11:05

Competitors	Kata	1T	1A	2T	2A	3T	3A	4T	4A	5T	5A	6T	6A	7T	7A	TEC	ATH	Extra	Total Rank
1 ANANDKUMAR VIKRANT (STEVESTON KARATE CLUB,CAN)	SUPARINPAI	(8.4)	(8.4)	8.4	8.0	8.4	8.2	(8.0)	(7.8)	8.0	8.2					17.36	7.32		24.681
2 NAKAJIMA KAICHI (WEST RIVER,CAN)	UNSU	(8.6)	(8.6)	8.2	8.0	8.0	8.2	8.2	8.2	(7.6)	(7.8)					17.08	7.32		24.4 2

Results

1	ANANDKUMAR VIKRANT	STEVESTON KARATE CLUB		CANADA
2	NAKAJIMA KAICHI	WEST RIVER		CANADA
3	MORI HARUKI	STEVESTON KARATE CLUB		CANADA
3	SPUR BRAYDEN	WEST RIVER		CANADA



KARATE BC

2019 Karate BC Provincial Championships - 2019-11-30

EK-8 Male Junior (16/17) Kata

EK-8 Male Junior (16/17) Kata R1 G1/2 (5) Tatami 4 09:00

Competitors	Kata	1T	1A	2T	2A	3T	3A	4T	4A	5T	5A	6T	6A	7T	7A	TEC	ATH	Extra	Total Rank
1 WONG AJ (BURNABY CHITO RYU YUSEIKAN,CAN)	SEISAN	7.0	7.2	(7.6)	(8.0)	(6.0)	6.6	6.8	(6.4)	7.0	7.0	(5.0)	(5.0)	(10.0)	(10.0)	14.56	6.24		20.8 3
2 MEISURIA HARSH (WEST RIVER,CAN)	HEIKU	(5.8)	(5.8)	6.4	6.6	6.6	7.0	7.0	6.6	(7.8)	(8.2)	(5.0)	(5.0)	(10.0)	(10.0)	14.0	6.06		20.065
3 MOVOLD ALEXANDER (NORTH WEST SHITO-KAI,CAN)	ANAN	(8.4)	(7.8)	(6.6)	(7.2)	7.2	7.8	8.0	7.6	7.6	7.2	(5.0)	(5.0)	(10.0)	(10.0)	15.96	6.78		22.741
4 WILKINSON GABRIEL (PRINCETON RENSHIKAN SHITO-RYU KARATE CLUB,CAN)	NIPAPO	(5.8)	(6.2)	6.6	7.0	6.8	6.8	7.6	7.2	(8.2)	(8.4)	(5.0)	(5.0)	(10.0)	(10.0)	14.7	6.3		21.0 2
5 REBIC NIKOLA (BURNABY CHITO RYU YUSEIKAN,CAN)	BASSAI	(7.8)	(7.6)	(6.4)	6.6	6.8	(6.4)	7.0	6.8	6.8	6.6	(5.0)	(5.0)	(10.0)	(10.0)	14.42	6.0		20.424

EK-8 Male Junior (16/17) Kata R1 G2/2 (4) Tatami 4 09:20

Competitors	Kata	1T	1A	2T	2A	3T	3A	4T	4A	5T	5A	6T	6A	7T	7A	TEC	ATH	Extra	Total Rank
1 IZEN SPENCER (WEST RIVER,CAN)	ANAN	(7.6)	(7.4)	7.2	7.4	(6.8)	(6.6)	7.2	7.2	7.4	7.4	(5.0)	(5.0)	(10.0)	(10.0)	15.26	6.6		21.862
2 POTORIEKO TREVOR (NORTH WEST SHITO-KAI,CAN)	ANAN	(6.8)	(6.4)	6.8	7.0	7.0	6.8	(7.2)	(7.4)	6.8	7.0	(5.0)	(5.0)	(10.0)	(10.0)	14.42	6.24		20.664
3 WASADA SOTARO (KINGSWAY SHITO-RYU,CAN)	PAPUREN	(8.4)	(8.6)	7.8	(7.8)	(7.4)	7.8	8.2	8.2	7.8	8.0	(5.0)	(5.0)	(10.0)	(10.0)	16.66	7.2		23.861
4 MISCEVIC MILOS (BURNABY CHITO RYU YUSEIKAN,CAN)	CHINTO	(7.8)	(7.6)	(6.6)	7.2	7.0	7.6	7.2	(6.8)	6.8	6.8	(5.0)	(5.0)	(10.0)	(10.0)	14.7	6.48		21.183

EK-8 Male Junior (16/17) Kata R2 Bronze Medal Match 1 Tatami 4 09:40

Competitors	Kata	1T	1A	2T	2A	3T	3A	4T	4A	5T	5A	6T	6A	7T	7A	TEC	ATH	Extra	Total Rank
1 WILKINSON GABRIEL (PRINCETON RENSHIKAN SHITO-RYU KARATE CLUB,CAN)	CHATANYARA KUSHANKU	6.8	(6.2)	(6.4)	7.2	6.8	7.0	7.4	7.2	(7.8)	(7.6)	(5.0)	(5.0)	(10.0)	(10.0)	14.7	6.42		21.121
2 MISCEVIC MILOS (BURNABY CHITO RYU YUSEIKAN,CAN)	BASSAI	6.8	(7.0)	6.8	7.0	(6.6)	(6.6)	(7.2)	7.0	7.2	7.0	(5.0)	(5.0)	(10.0)	(10.0)	14.56	6.3		20.862

EK-8 Male Junior (16/17) Kata R2 Bronze Medal Match 2 Tatami 4 09:50

Competitors	Kata	1T	1A	2T	2A	3T	3A	4T	4A	5T	5A	6T	6A	7T	7A	TEC	ATH	Extra	Total Rank
1 WONG AJ (BURNABY CHITO RYU YUSEIKAN,CAN)	NISEISHI	(7.6)	(7.8)	(7.2)	(7.2)	7.2	7.2	7.6	7.8	7.4	7.4	(5.0)	(5.0)	(10.0)	(10.0)	15.54	6.72		22.262
2 IZEN SPENCER (WEST RIVER,CAN)	NIPAPO	7.2	7.6	(6.8)	7.2	(7.8)	7.4	7.8	(8.0)	7.6	(6.8)	(5.0)	(5.0)	(10.0)	(10.0)	15.82	6.66		22.481

EK-8 Male Junior (16/17) Kata R2 Gold Medal Match Tatami 4 10:00

Competitors	Kata	1T	1A	2T	2A	3T	3A	4T	4A	5T	5A	6T	6A	7T	7A	TEC	ATH	Extra	Total Rank
1 MOVOLD ALEXANDER (NORTH WEST SHITO-KAI,CAN)	ANAN DAI	7.6	7.8	(6.8)	(7.2)	(7.8)	7.4	7.6	(8.0)	7.6	7.2	(5.0)	(5.0)	(10.0)	(10.0)	15.96	6.72		22.682
2 WASADA SOTARO (KINGSWAY SHITO-RYU,CAN)	CHATANYARA KUSHANKU	8.0	7.8	8.0	8.0	(7.4)	(6.8)	(8.2)	(8.4)	7.8	7.8	(5.0)	(5.0)	(10.0)	(10.0)	16.66	7.08		23.741

Results

1	WASADA SOTARO	KINGSWAY SHITO-RYU		CANADA
2	MOVOLD ALEXANDER	NORTH WEST SHITO-KAI		CANADA
3	WILKINSON GABRIEL	PRINCETON RENSHIKAN SHITO-RYU KARATE CLUB		CANADA
3	IZEN SPENCER	WEST RIVER		CANADA

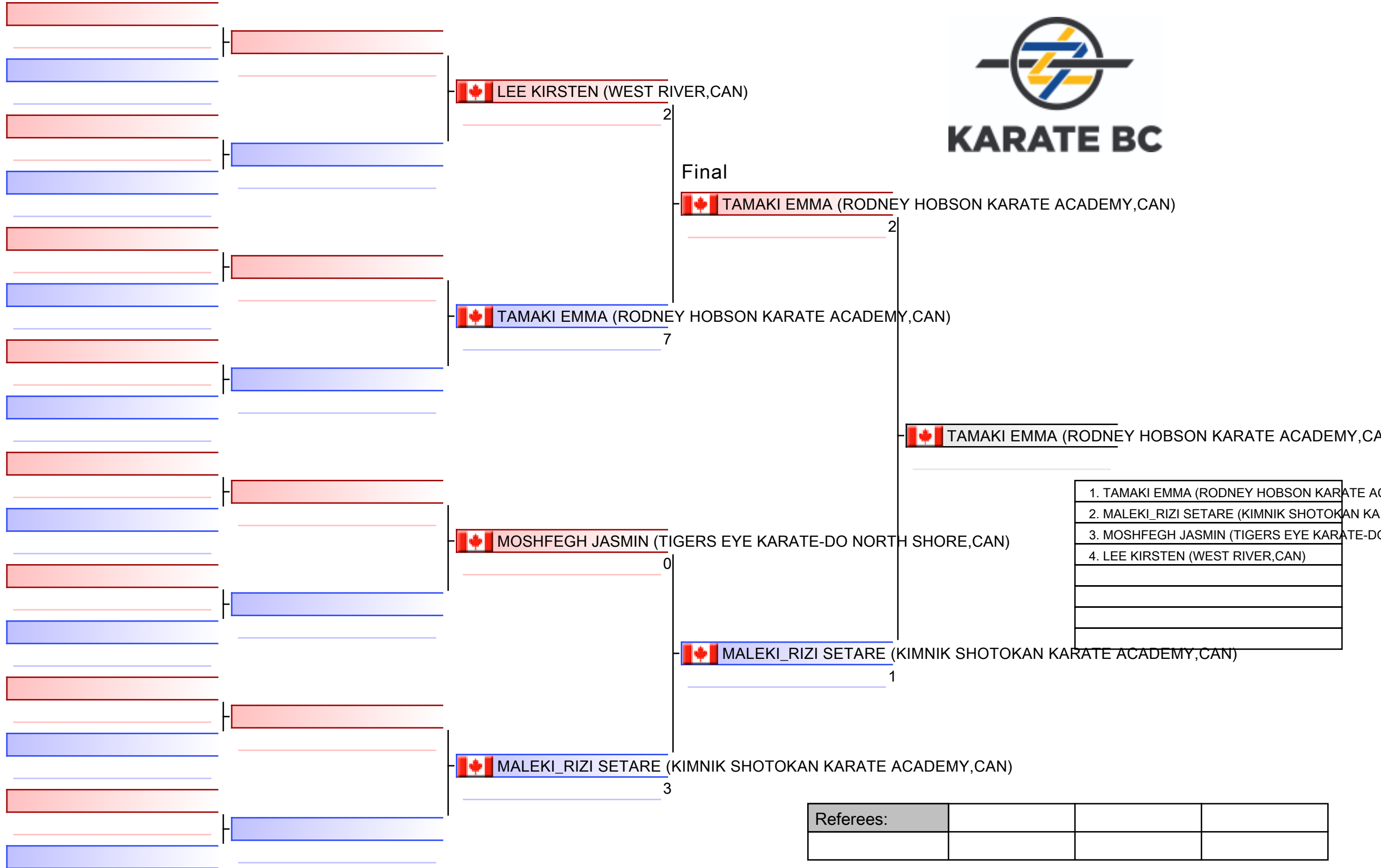

ES-10 Female Junior (16/17) Kumite -59kg

2019 Karate BC Provincial Championships

(c)sportdata GmbH & Co KG 2000-2019(2019-12-04 00:07) -WKF Approved- v 9.8.6 build 2 License: Karate BC (expire 2020-10-12)

Tatami

Pool

1

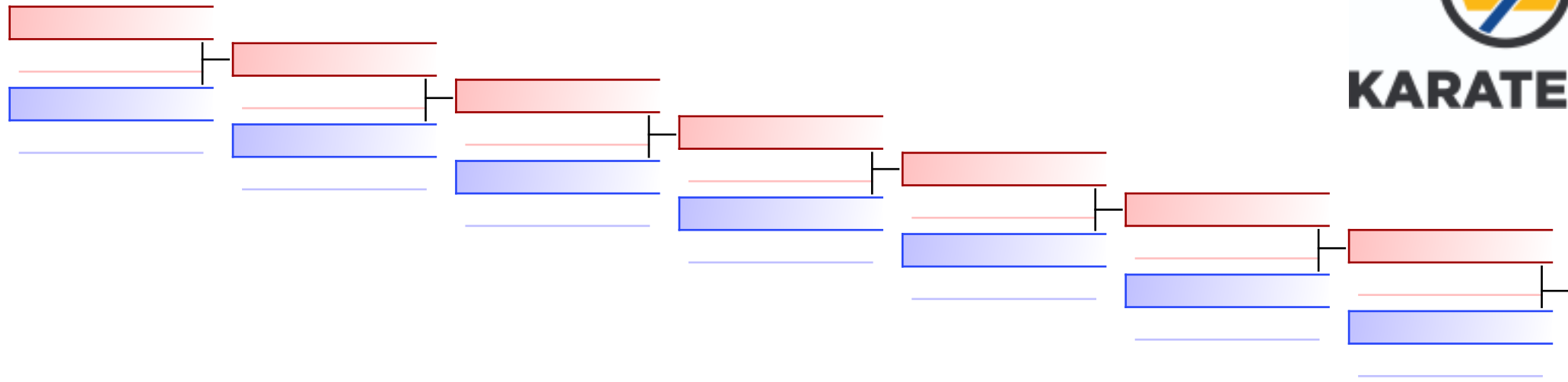

REPECHAGE: (1)

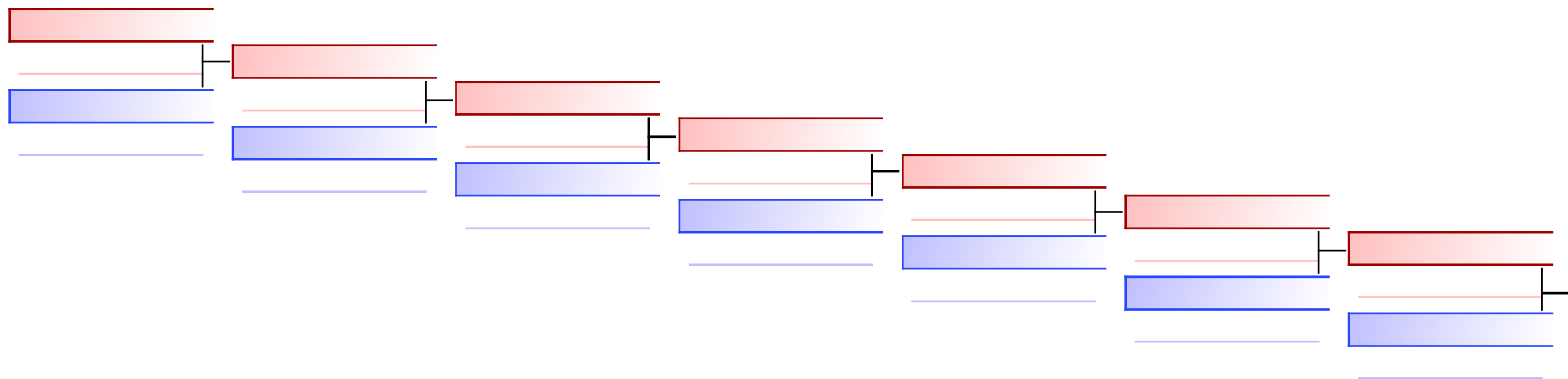

 LEE KIRSTEN (WEST RIVER, CAN) 0

 MOSHFEGH JASMIN (TIGERS EYE) 0

 MOSHFEGH JASMIN (TIGERS EYE) 1

Referees:							
-----------	--	--	--	--	--	--	--

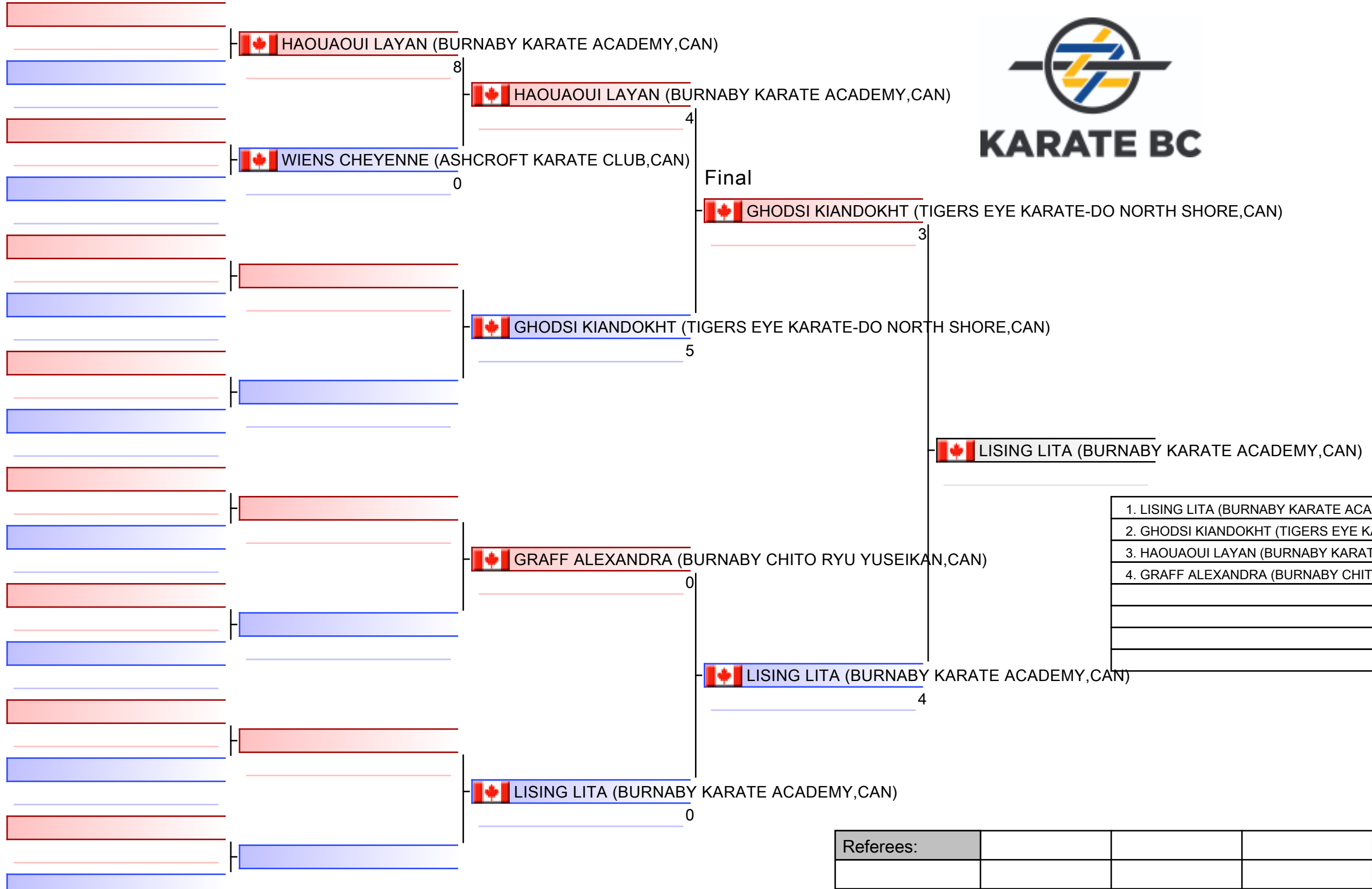

1. LISING LITA (BURNABY KARATE ACADEMY,CAN)
2. GHODSI KIANDOKHT (TIGERS EYE KARATE-DO NORTH SHORE,CAN)
3. HAOUAOUI LAYAN (BURNABY KARATE ACADEMY,CAN)
4. GRAFF ALEXANDRA (BURNABY CHITO RYU YUSEIKAN,CAN)

Referees:			

ES-11 Female Junior (16/17) Kumite +59kg

2019 Karate BC Provincial Championships

(c)sportdata GmbH & Co KG 2000-2019(2019-12-04 00:07) -WKF Approved- v 9.8.6 build 2 License: Karate BC (expire 2020-10-12)

Tatami
2 11:40

Pool
1

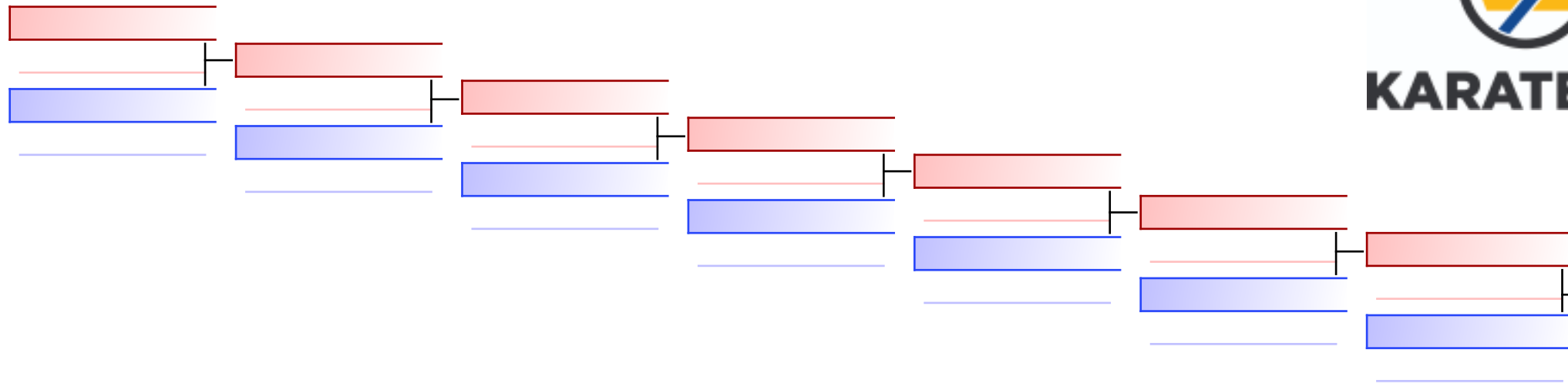

REPECHAGE: (1)

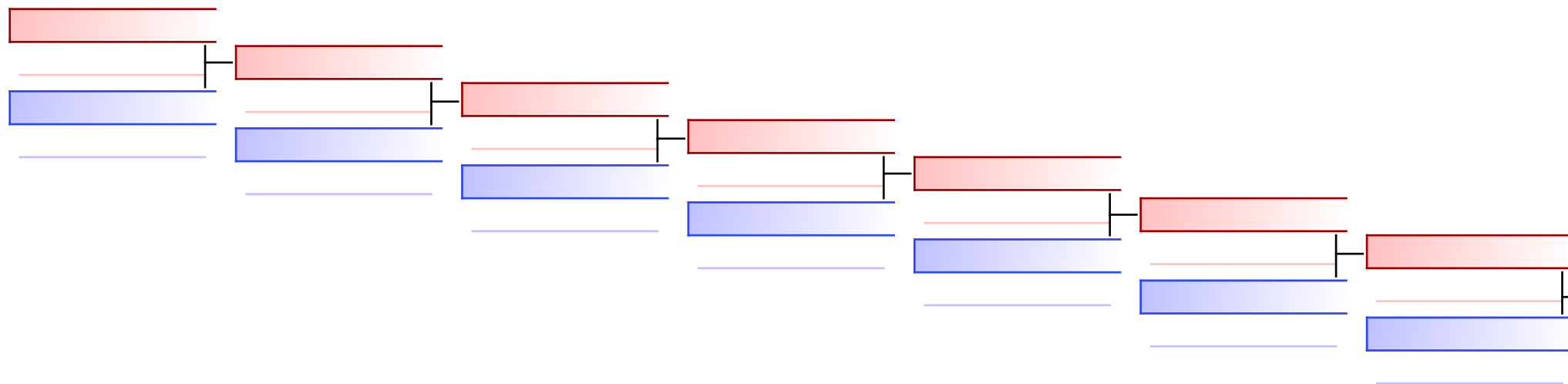

 HAOUAQUI LAYAN (BURNABY K)
8

 HAOUAQUI LAYAN (BURNABY K)

 GRAFF ALEXANDRA (BURNABY)
1

Referees:							
-----------	--	--	--	--	--	--	--

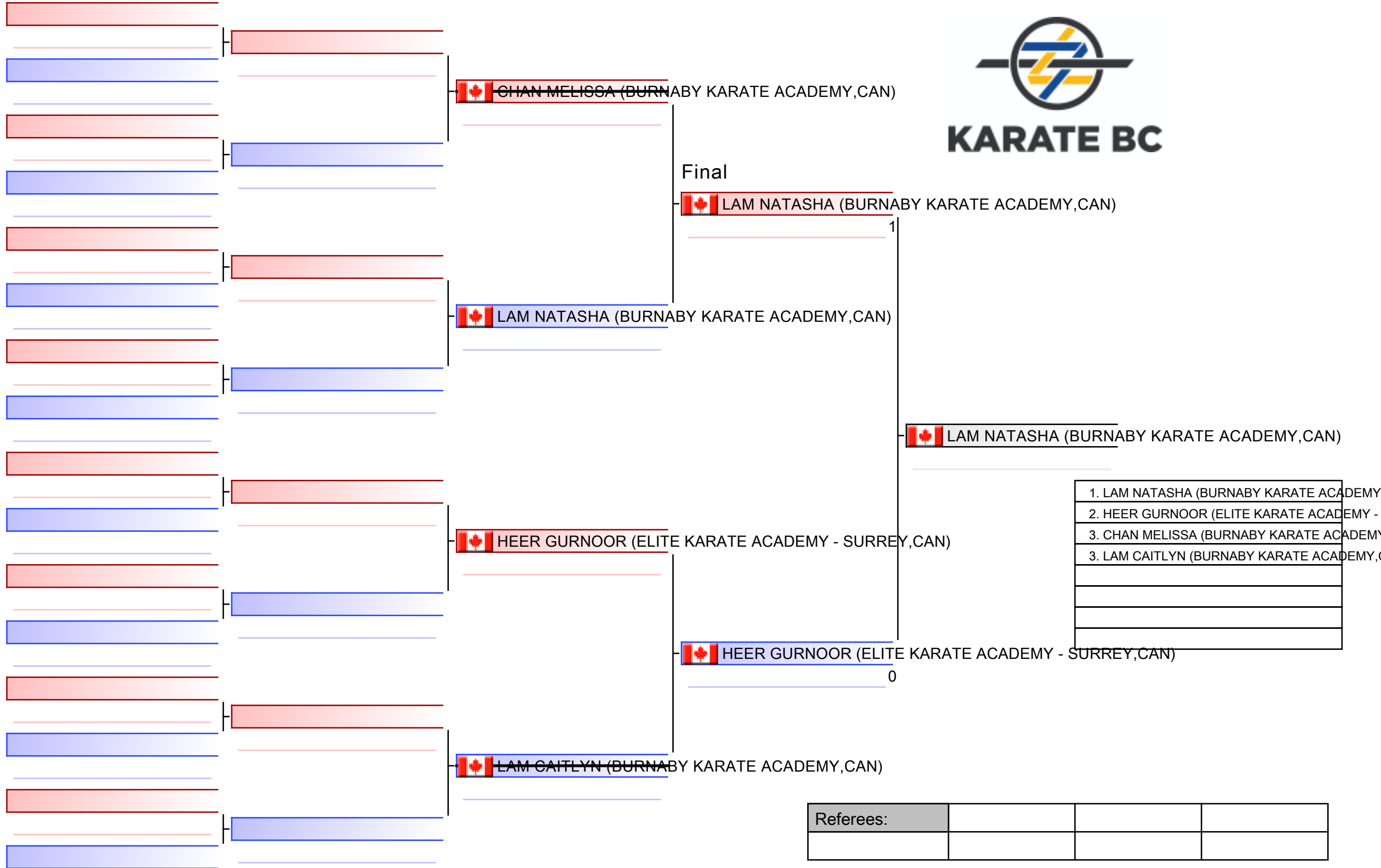

1. LAM NATASHA (BURNABY KARATE ACADEMY, CAN)
2. HEER GURNOOR (ELITE KARATE ACADEMY - SURREY, CAN)
3. CHAN MELISSA (BURNABY KARATE ACADEMY, CAN)
3. LAM CAITLYN (BURNABY KARATE ACADEMY, CAN)

Referees:			

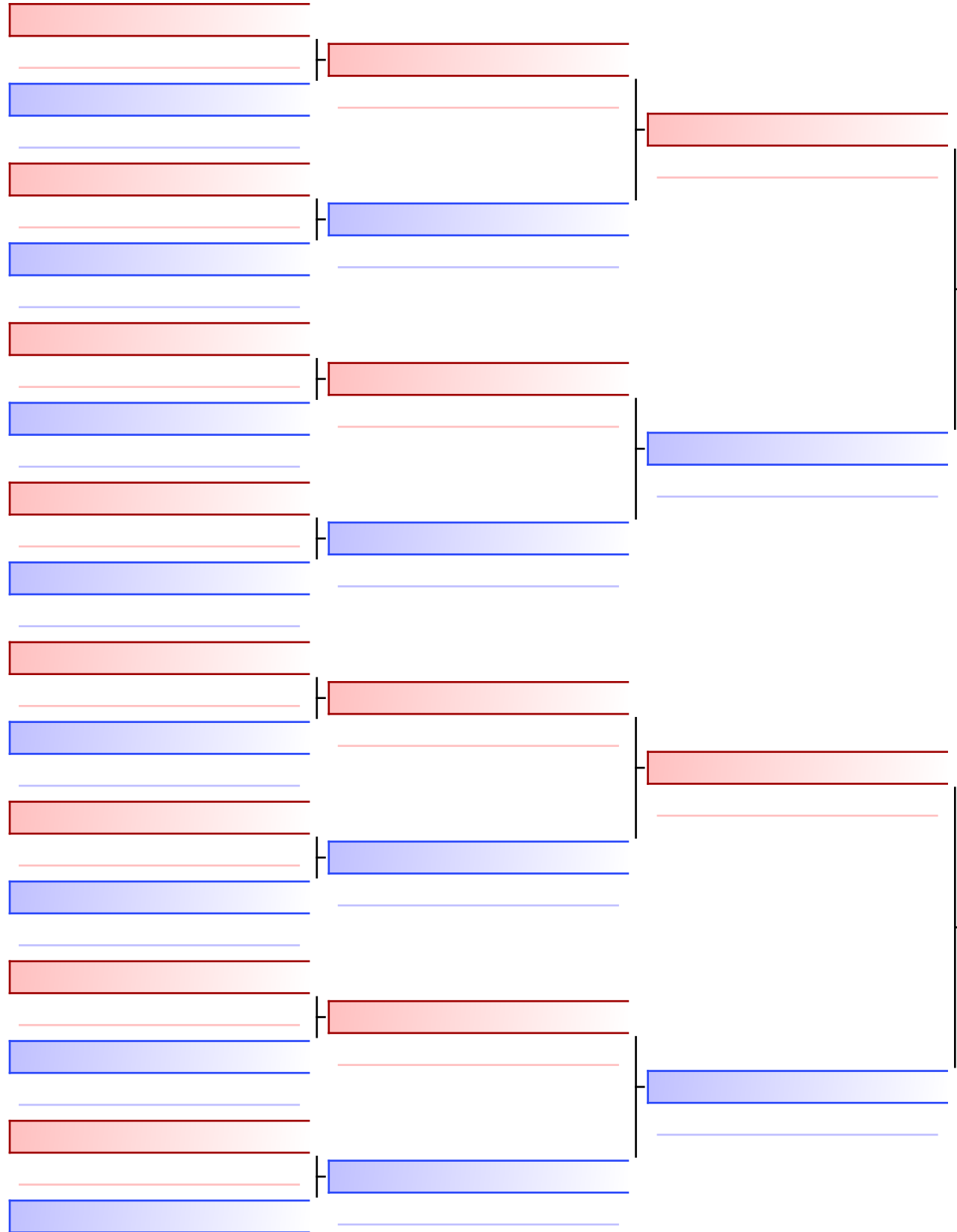

Final

VIRK MAANSI (ELITE KARATE ACADEMY - SURREY,CAN)

3

VIRK MAANSI (ELITE KARATE ACADEMY - SURREY,CAN)

SOEHARDHI MAYA (BURNABY KARATE ACADEMY,CAN)

1

1. VIRK MAANSI (ELITE KARATE ACADEMY - SURREY,CAN)
2. SOEHARDHI MAYA (BURNABY KARATE ACADEMY,CAN)

Referees:			

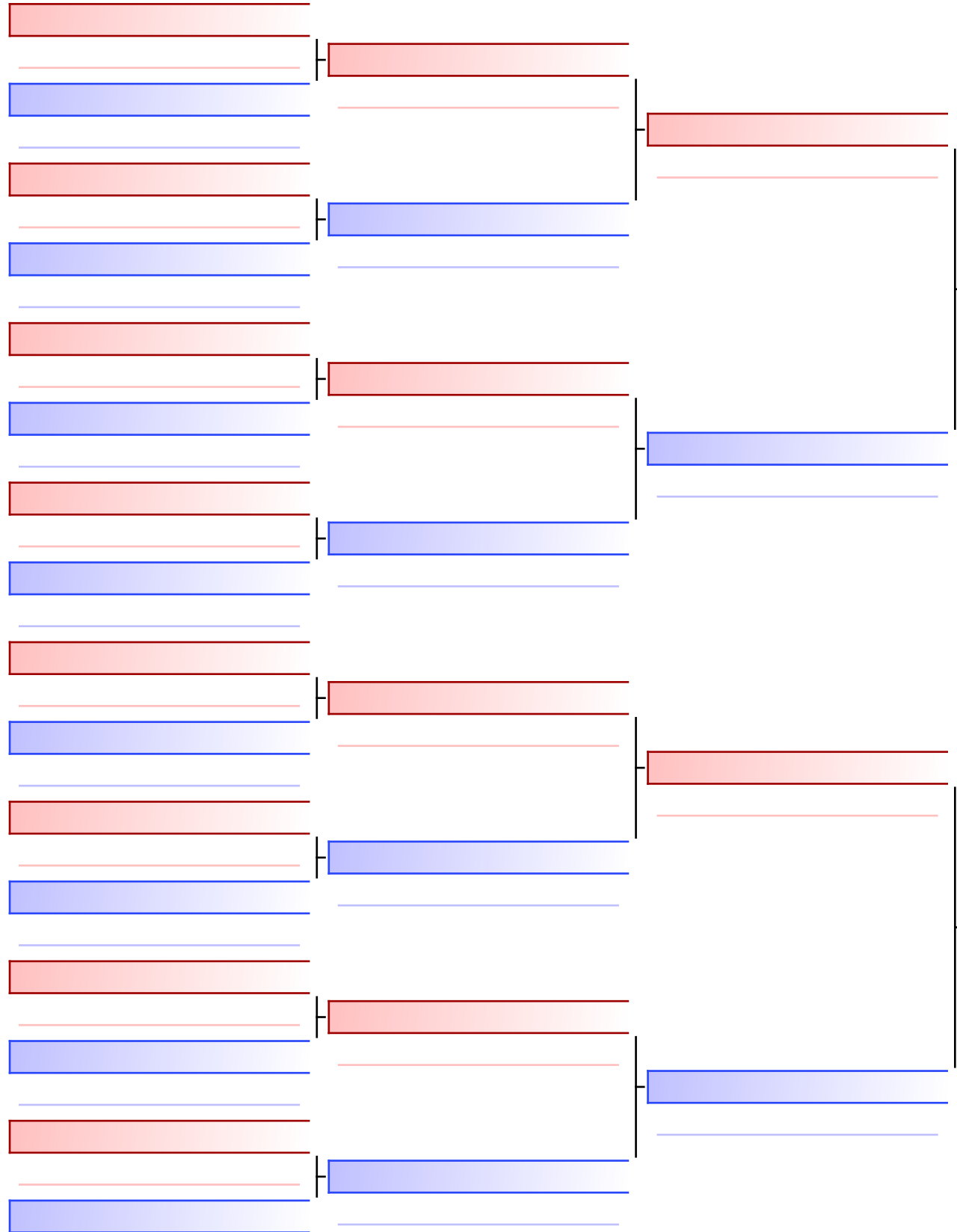

Final

DHILLON SACHREET (ELITE KARATE ACADEMY - SURREY,CAN)

3

DHILLON SACHREET (ELITE KARATE ACADEMY - SURREY,CAN)

HUANG JANNA (BURNABY KARATE ACADEMY,CAN)

1

1. DHILLON SACHREET (ELITE KARATE ACADEMY - SURREY,CAN)
2. HUANG JANNA (BURNABY KARATE ACADEMY,CAN)









Referees:			

ES-15 Female U21 Kumite -68kg - Round Robin (each against each)

2019 Karate BC Provincial Championships, CAN

Tatami
4 11:30

Pool
1/1

- 1  NOURI SETAREH (TIGERS EYE KARATE-DO NORTH SHORE,CAN)
6 |  NOURI SETAREH (TIGERS EYE KARATE-DO NORTH SHORE,CAN)
- 2  DEVLIN SOFIA (VARSITY PERFORMANCE KARATE CLUB,CAN)
0
- 3  NOURI SETAREH (TIGERS EYE KARATE-DO NORTH SHORE,CAN)
2 |  MACLEAN JULIA (BURNABY KARATE ACADEMY,CAN)
- 4  MACLEAN JULIA (BURNABY KARATE ACADEMY,CAN)
4
- 5  DEVLIN SOFIA (VARSITY PERFORMANCE KARATE CLUB,CAN)
1 |  MACLEAN JULIA (BURNABY KARATE ACADEMY,CAN)
- 6  MACLEAN JULIA (BURNABY KARATE ACADEMY,CAN)
2



1. MACLEAN JULIA (BURNABY KARATE ACADEMY,CAN)
2. NOURI SETAREH (TIGERS EYE KARATE-DO NORTH SHORE,CAN)
3. DEVLIN SOFIA (VARSITY PERFORMANCE KARATE CLUB,CAN)

Referees:				

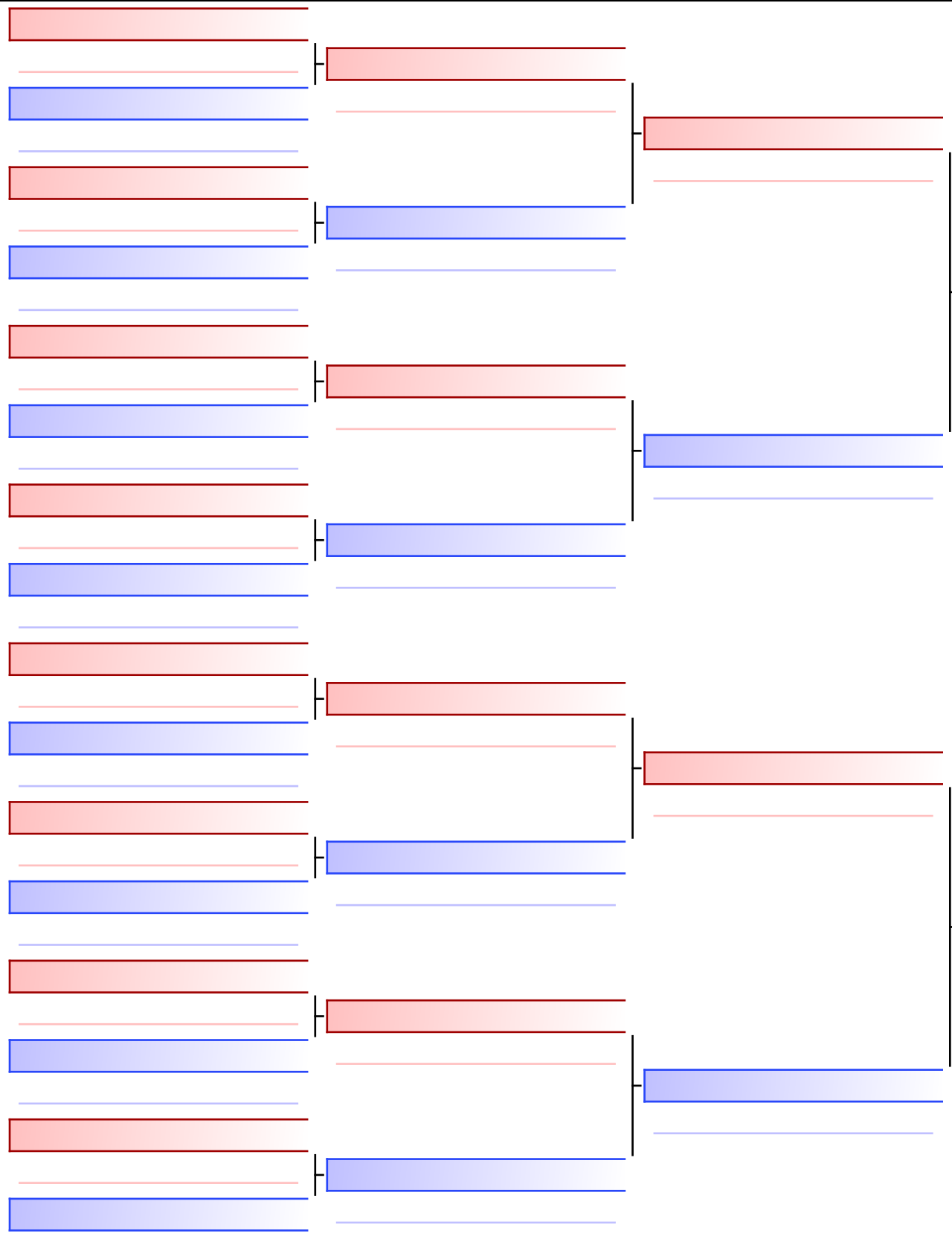

Final

 CHAN MELISSA (BURNABY KARATE ACADEMY, CAN)

0

 CHAN ISABEL (BURNABY KARATE ACADEMY, CAN)

 CHAN ISABEL (BURNABY KARATE ACADEMY, CAN)

0

1. CHAN ISABEL (BURNABY KARATE ACADEMY, CAN)
2. CHAN MELISSA (BURNABY KARATE ACADEMY, CAN)

Referees:			

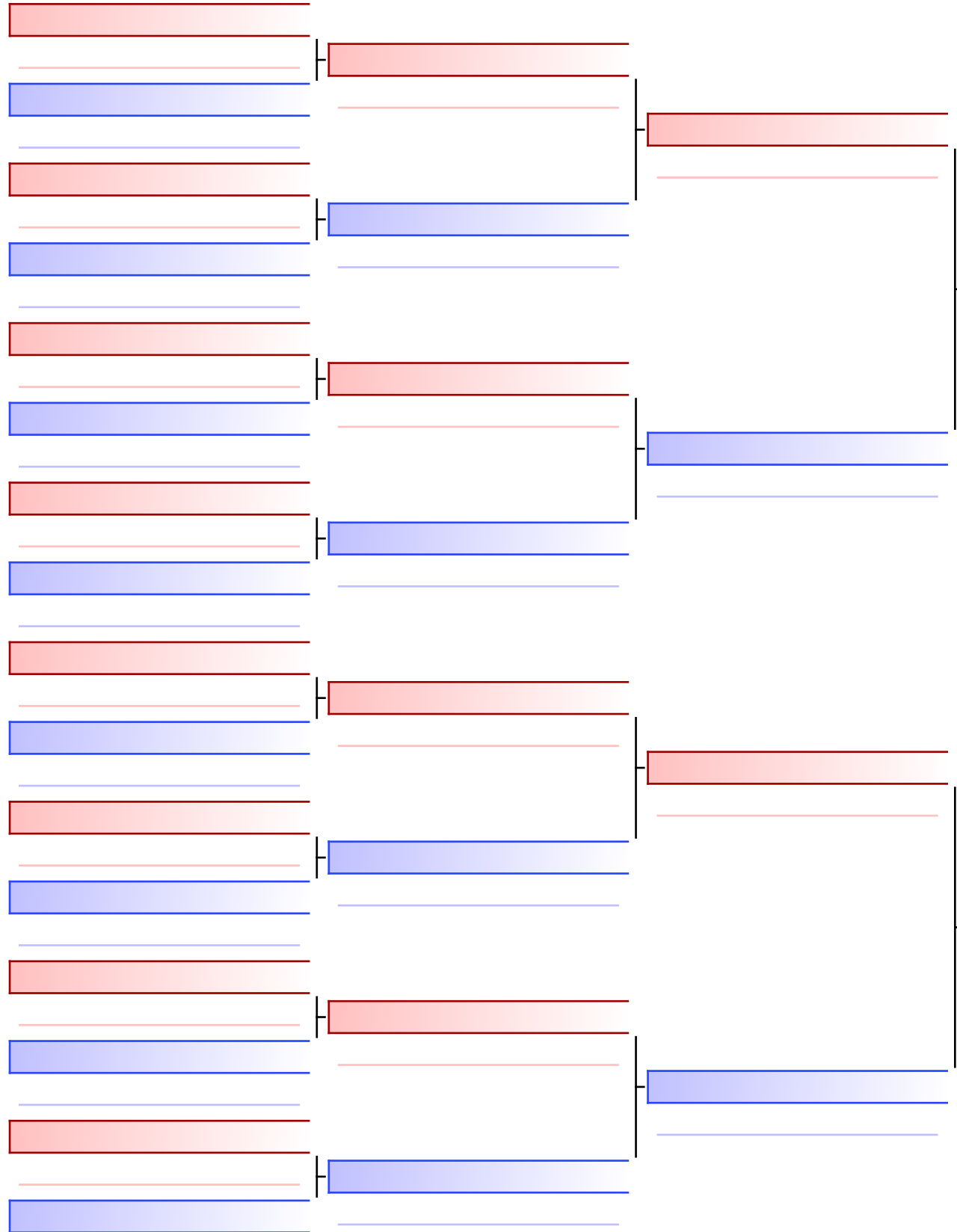

Final

MAYAN PARVIN (WEST VAN KARATE ACADEMY,CAN)

1

MAYAN PARVIN (WEST VAN KARATE ACADEMY,CAN)

FENNELL JOCELYN (WEST VAN KARATE ACADEMY,CAN)

0

1. MAYAN PARVIN (WEST VAN KARATE ACADEMY,CAN)
2. FENNELL JOCELYN (WEST VAN KARATE ACADEMY,CAN)









Referees:			

ES-1 Female Youth (12/13) Kumite -42kg - Round Robin (each against each)

2019 Karate BC Provincial Championships, CAN

Tatami
1 13:00

Pool
1/1

- 1  SHARMA NIKITA (BURNABY KARATE ACADEMY,CAN)
8 |  SHARMA NIKITA (BURNABY KARATE ACADEMY,CAN)
- 2  CASACLANG ABIGAIL (KINGSWAY SHITO-RYU,CAN)
0
- 3  SHARMA NIKITA (BURNABY KARATE ACADEMY,CAN)
5 |  SHARMA NIKITA (BURNABY KARATE ACADEMY,CAN)
- 4  DHILLON GURSIMAR (ELITE KARATE ACADEMY - SURREY,CAN)
0
- 5  CASACLANG ABIGAIL (KINGSWAY SHITO-RYU,CAN)
4 |  CASACLANG ABIGAIL (KINGSWAY SHITO-RYU,CAN)
- 6  DHILLON GURSIMAR (ELITE KARATE ACADEMY - SURREY,CAN)
0



1. SHARMA NIKITA (BURNABY KARATE ACADEMY)
2. CASACLANG ABIGAIL (KINGSWAY SHITO-RYU)
3. DHILLON GURSIMAR (ELITE KARATE ACADEMY)

Referees:				

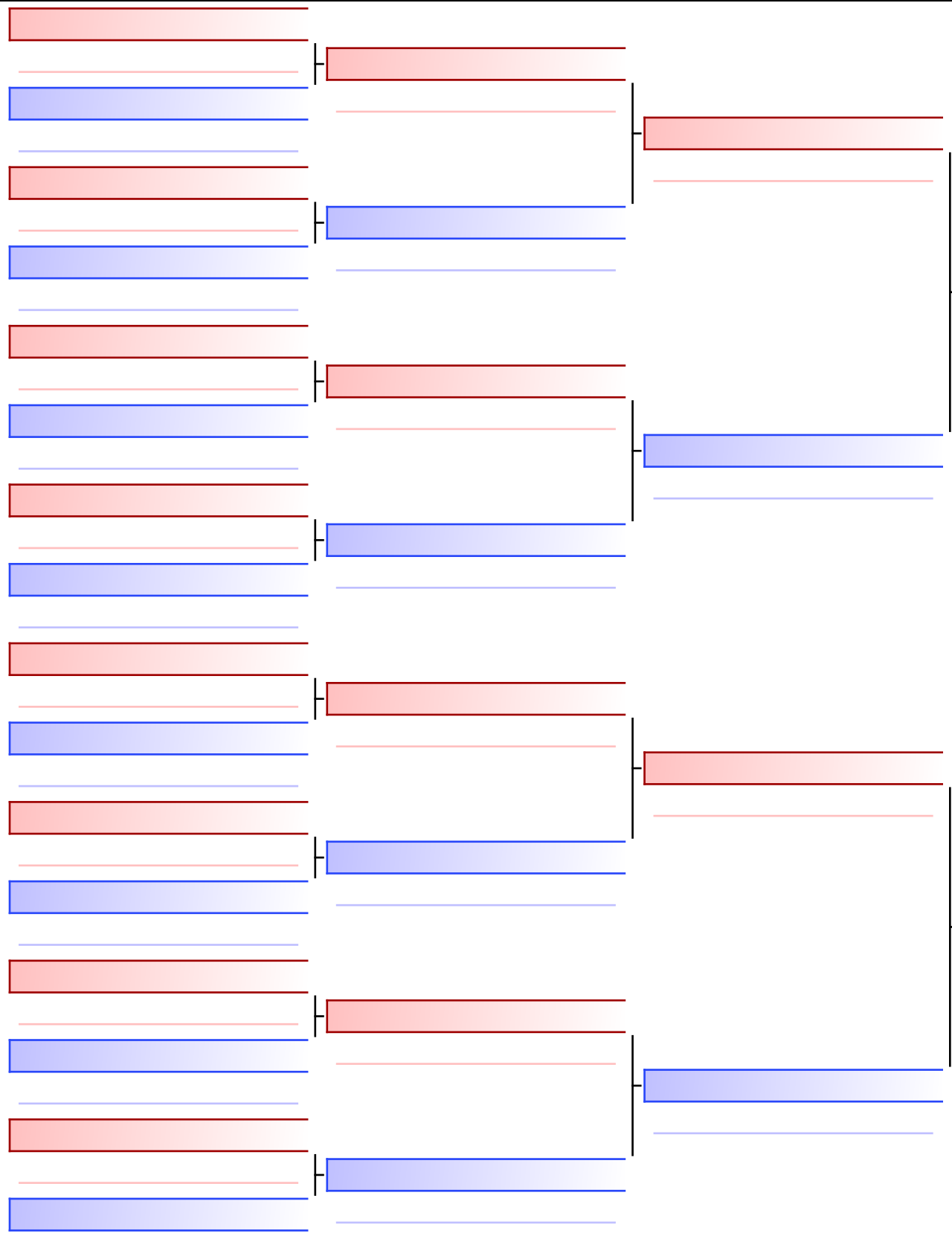

Final

FENNELL JOCELYN (WEST VAN KARATE ACADEMY,CAN)

6

FENNELL JOCELYN (WEST VAN KARATE ACADEMY,CAN)

HADDEN HANNAH (WEST COAST GOJU-KAI,CAN)

0

1. FENNELL JOCELYN (WEST VAN KARATE ACADEMY,CAN)
2. HADDEN HANNAH (WEST COAST GOJU-KAI,CAN)

Referees:			

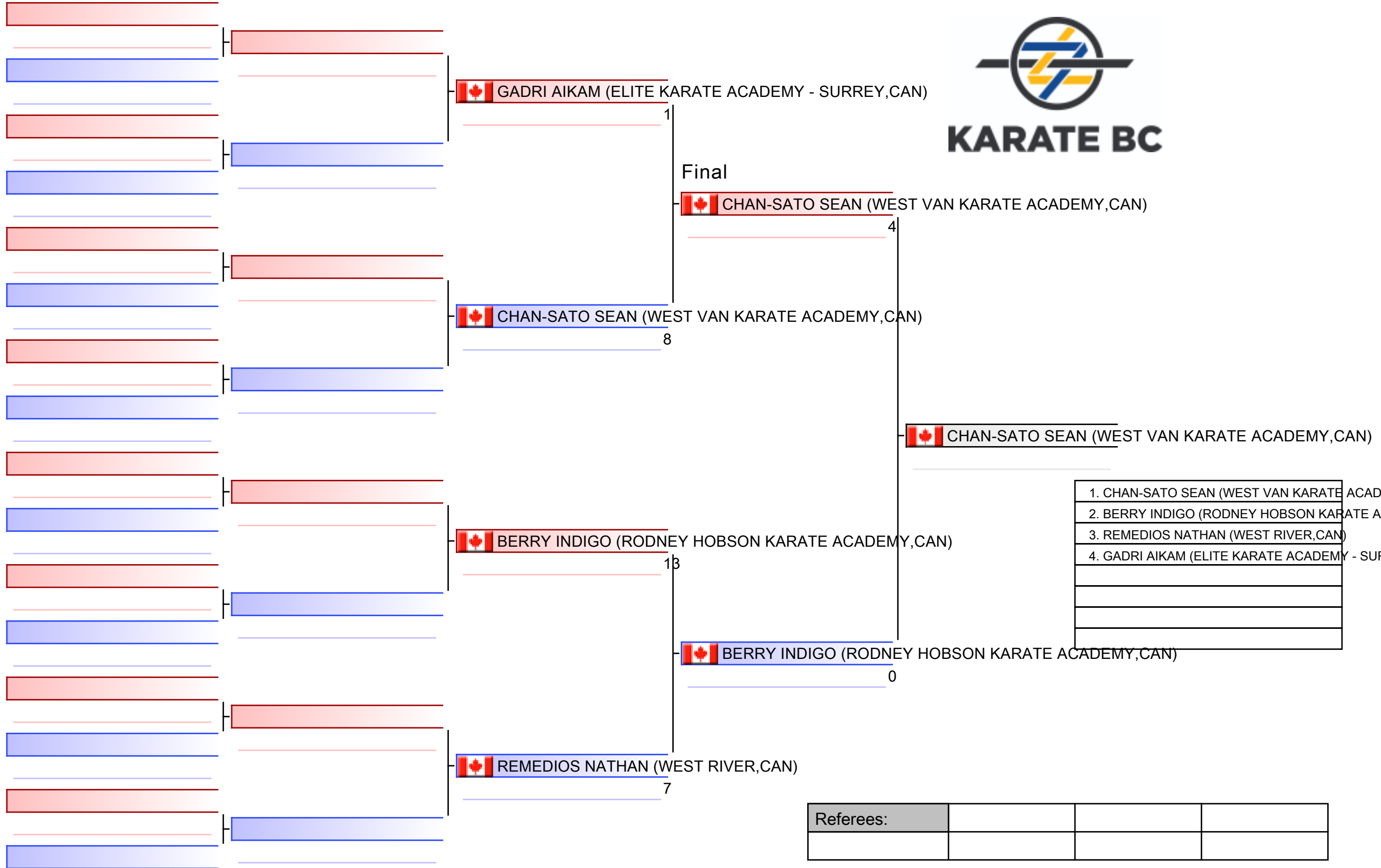

ES-25 Male Youth (12/13) Kumite -40kg

2019 Karate BC Provincial Championships

(c)sportdata GmbH & Co KG 2000-2019(2019-12-04 00:07) -WKF Approved- v 9.8.6 build 2 License: Karate BC (expire 2020-10-12)

Tatami

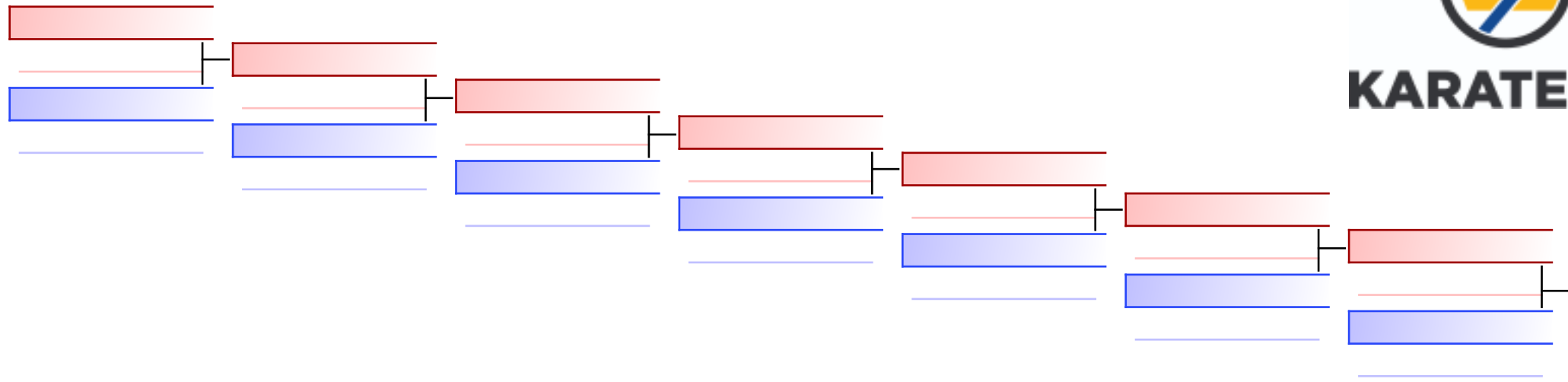

Pool

1

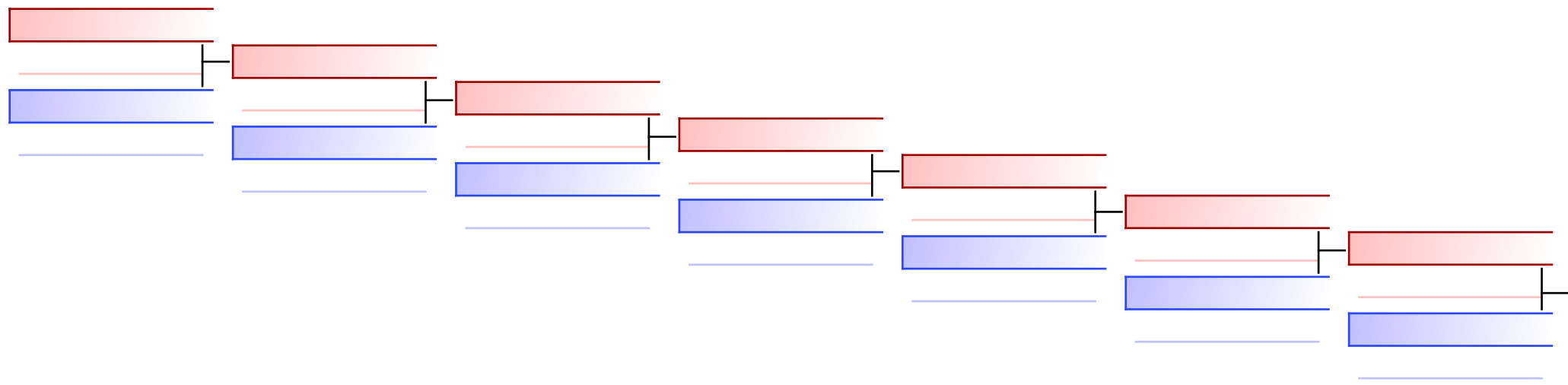

REPECHAGE: (1)



-  **GADRI AIKAM (ELITE KARATE A**
0
-  **REMEDIOS NATHAN (WEST RIVE**
-  **REMEDIOS NATHAN (WEST RIVE**
8

Referees:							
-----------	--	--	--	--	--	--	--



KARATE BC

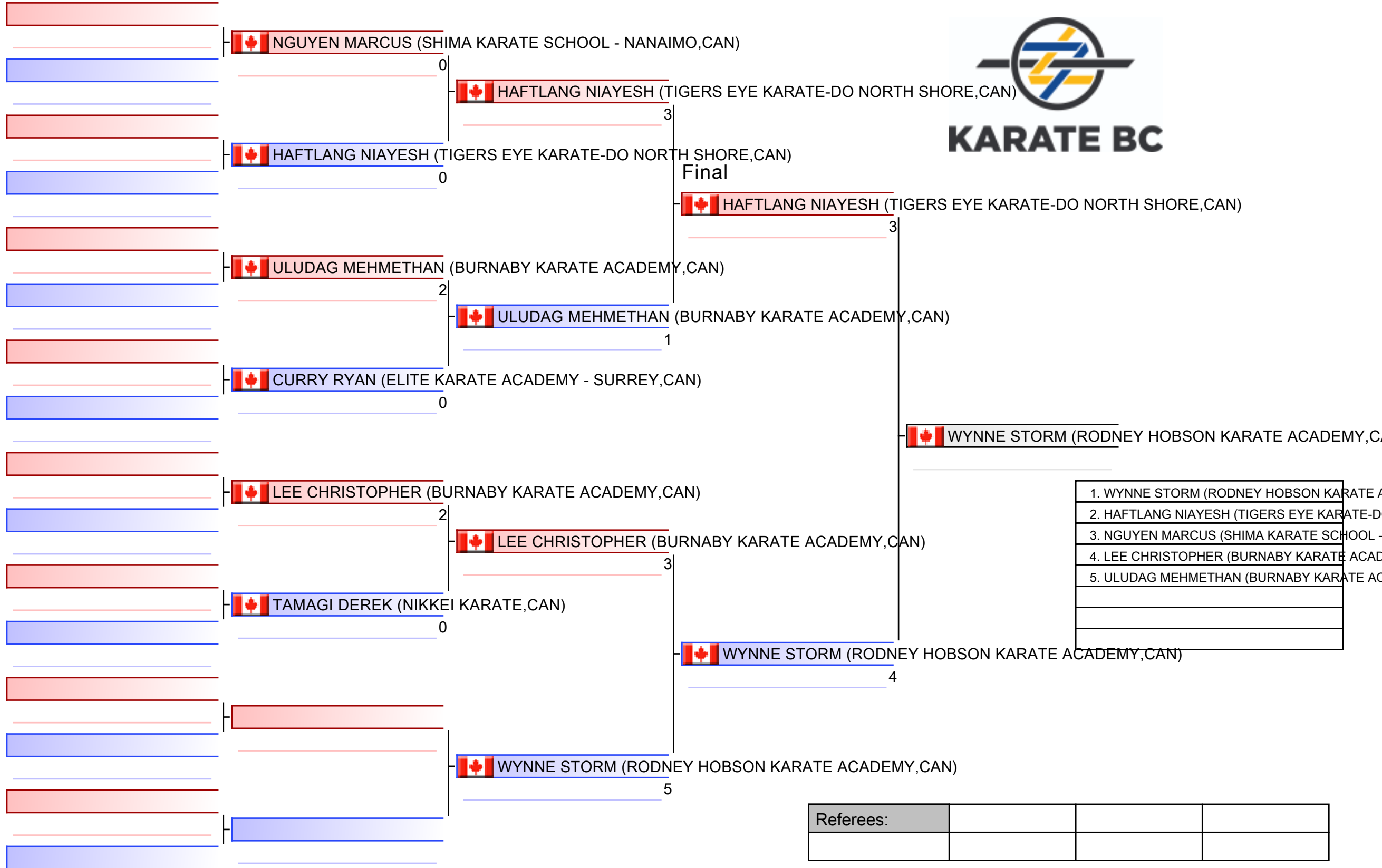

ES-26 Male Youth (12/13) Kumite -45kg

2019 Karate BC Provincial Championships

(c)sportdata GmbH & Co KG 2000-2019(2019-12-04 00:07) -WKF Approved- v 9.8.6 build 2 License: Karate BC (expire 2020-10-12)

Tatami
3 12:50

Pool
1

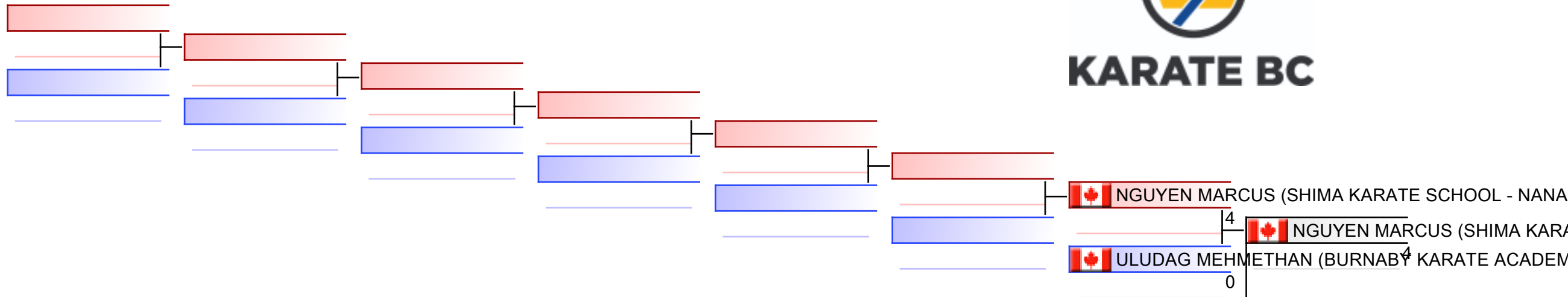

REPECHAGE: (1)

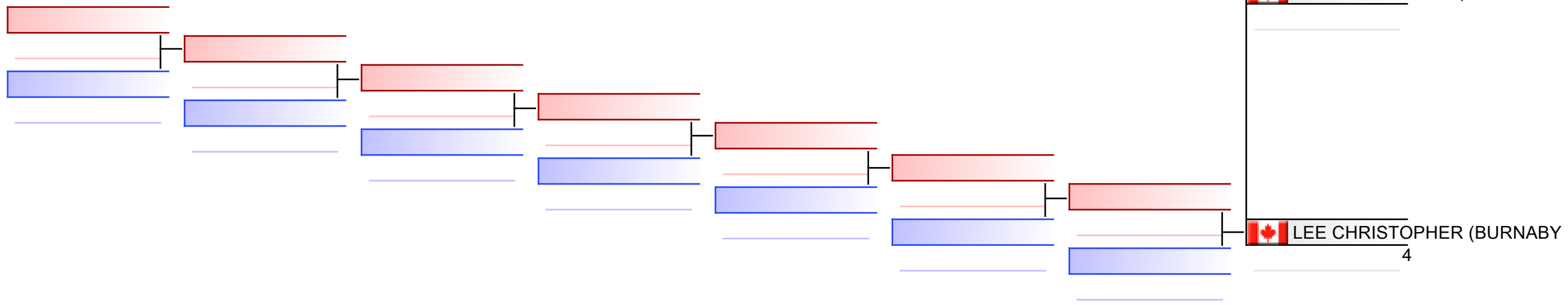

Referees:							
-----------	--	--	--	--	--	--	--

ES-27 Male Youth (12/13) Kumite -50kg

2019 Karate BC Provincial Championships, CAN

Tatami
4 12:55

Pool
1/1

 SMITH OLAN (BURNABY KARATE ACADEMY,CAN)

5  SMITH OLAN (BURNABY KARATE ACADEMY,CAN)

 NEUFELD ISAAC (BURNABY CHITO RYU YUSEIKAN,CAN)

2  SMITH OLAN (BURNABY KARATE ACADEMY,CAN)

 VILLAMENTE NEILL (WEST RIVER,CAN)

0

 CHIU ANSON (BURNABY KARATE ACADEMY,CAN)

0

 TAKENAKA YUTA (KINGSWAY SHITO-RYU,CAN)

2

 GARDENER DYLAN (KENZEN SPORTS KARATE,CAN)

2

 PAREJA AIDAN (BURNABY KARATE ACADEMY,CAN)

2

 HOPEWELL OWEN (SHIMA KARATE SCHOOL - NANAIMO,CAN)

1

 MORI HARUKI (STEVESTON KARATE CLUB,CAN)

2

 SMITH OLAN (BURNABY KARATE ACADEMY,CAN)

1

 TAKENAKA YUTA (KINGSWAY SHITO-RYU,CAN)

0

 GARDENER DYLAN (KENZEN SPORTS KARATE,CAN)

0

 MORI HARUKI (STEVESTON KARATE CLUB,CAN)

1

Final

 SMITH OLAN (BURNABY KARATE ACADEMY,CAN)

0

 MORI HARUKI (STEVESTON KARATE CLUB,CAN)

4



- | |
|--|
| 1. MORI HARUKI (STEVESTON KARATE CLUB,CAN) |
| 2. SMITH OLAN (BURNABY KARATE ACADEMY,CAN) |
| 3. VILLAMENTE NEILL (WEST RIVER,CAN) |
| 4. HOPEWELL OWEN (SHIMA KARATE SCHOOL - NANAIMO,CAN) |
| 5. GARDENER DYLAN (KENZEN SPORTS KARATE,CAN) |
| 5. TAKENAKA YUTA (KINGSWAY SHITO-RYU,CAN) |
| 7. NEUFELD ISAAC (BURNABY CHITO RYU YUSEIKAN,CAN) |

Referees:			

ES-27 Male Youth (12/13) Kumite -50kg

2019 Karate BC Provincial Championships

(c)sportdata GmbH & Co KG 2000-2019(2019-12-04 00:07) -WKF Approved- v 9.8.6 build 2 License: Karate BC (expire 2020-10-12)

Tatami
4 13:35

Pool
1

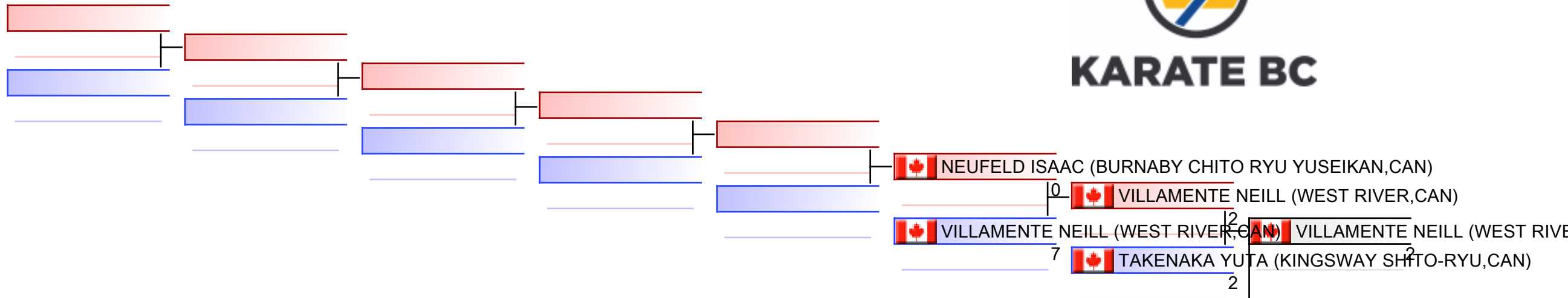

REPECHAGE: (1)

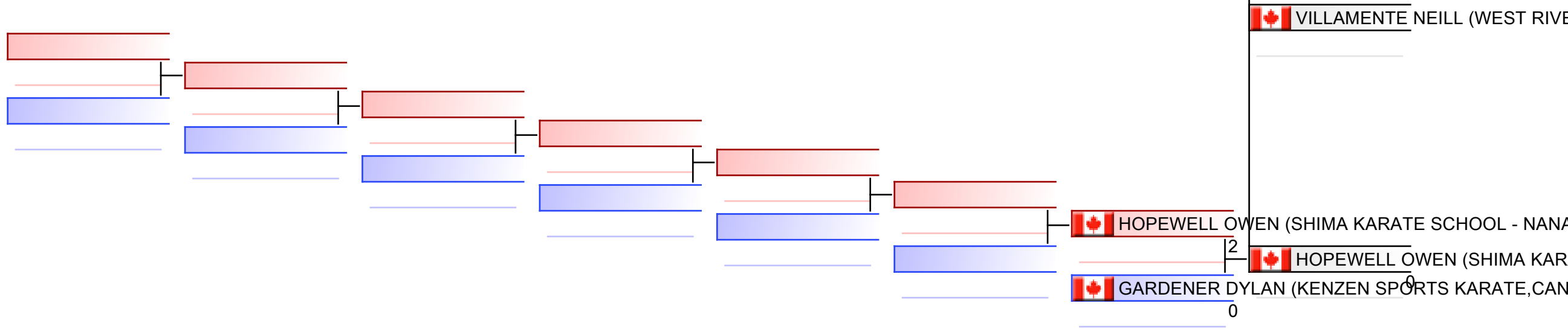

Referees:							
-----------	--	--	--	--	--	--	--

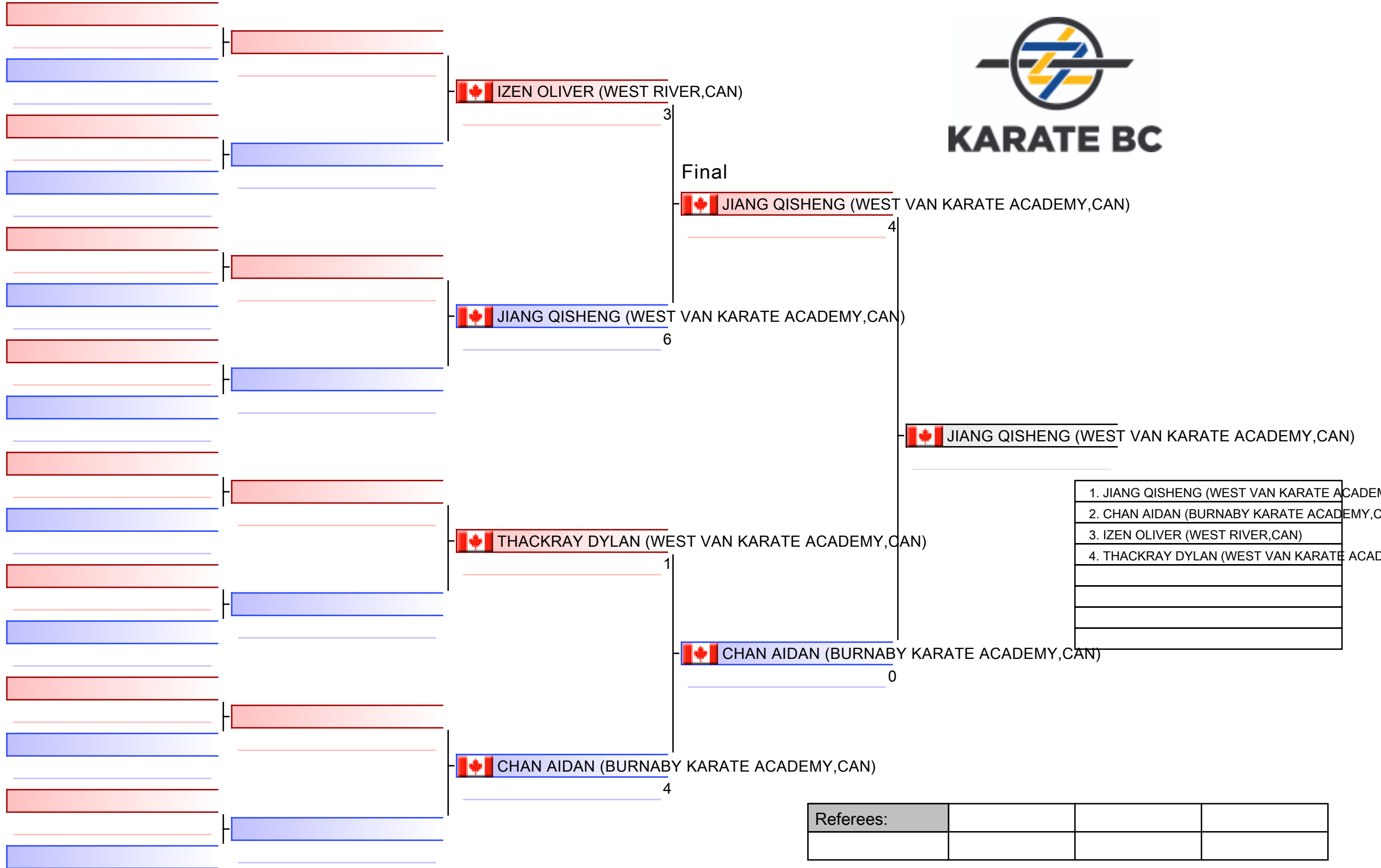

ES-28 Male Youth (12/13) Kumite -55kg

2019 Karate BC Provincial Championships

(c)sportdata GmbH & Co KG 2000-2019(2019-12-04 00:07) -WKF Approved- v 9.8.6 build 2 License: Karate BC (expire 2020-10-12)

Tatami

Pool

1

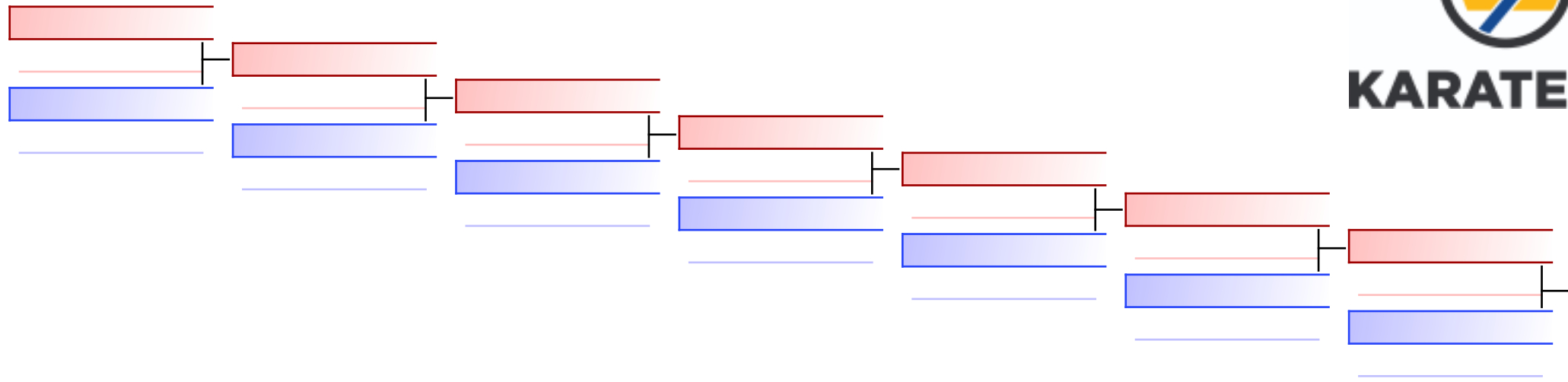

REPECHAGE: (1)

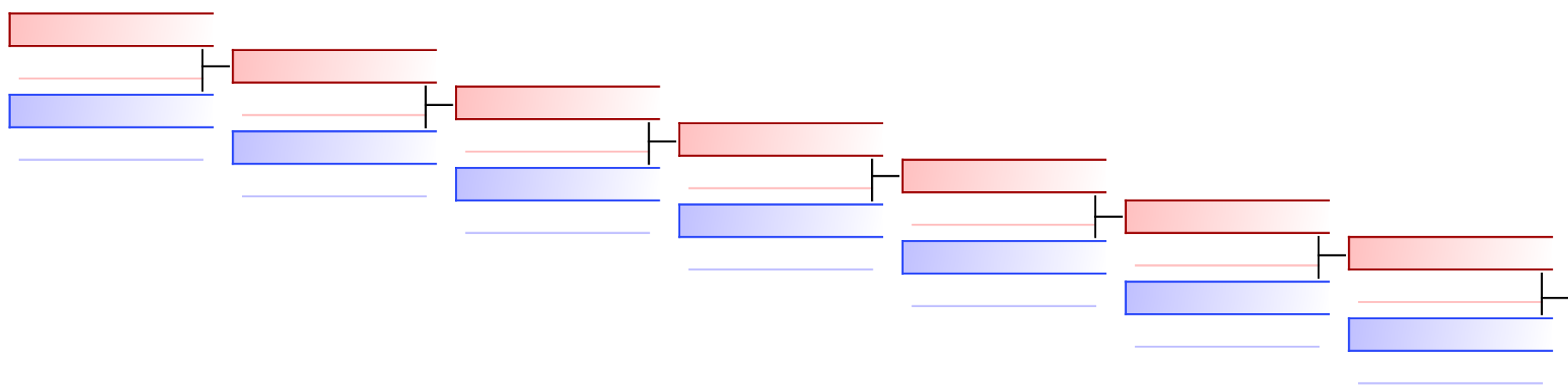

 IZEN OLIVER (WEST RIVER,CAN) 6

 IZEN OLIVER (WEST RIVER,CAN)

 THACKRAY DYLAN (WEST VAN) 3

Referees:							
-----------	--	--	--	--	--	--	--

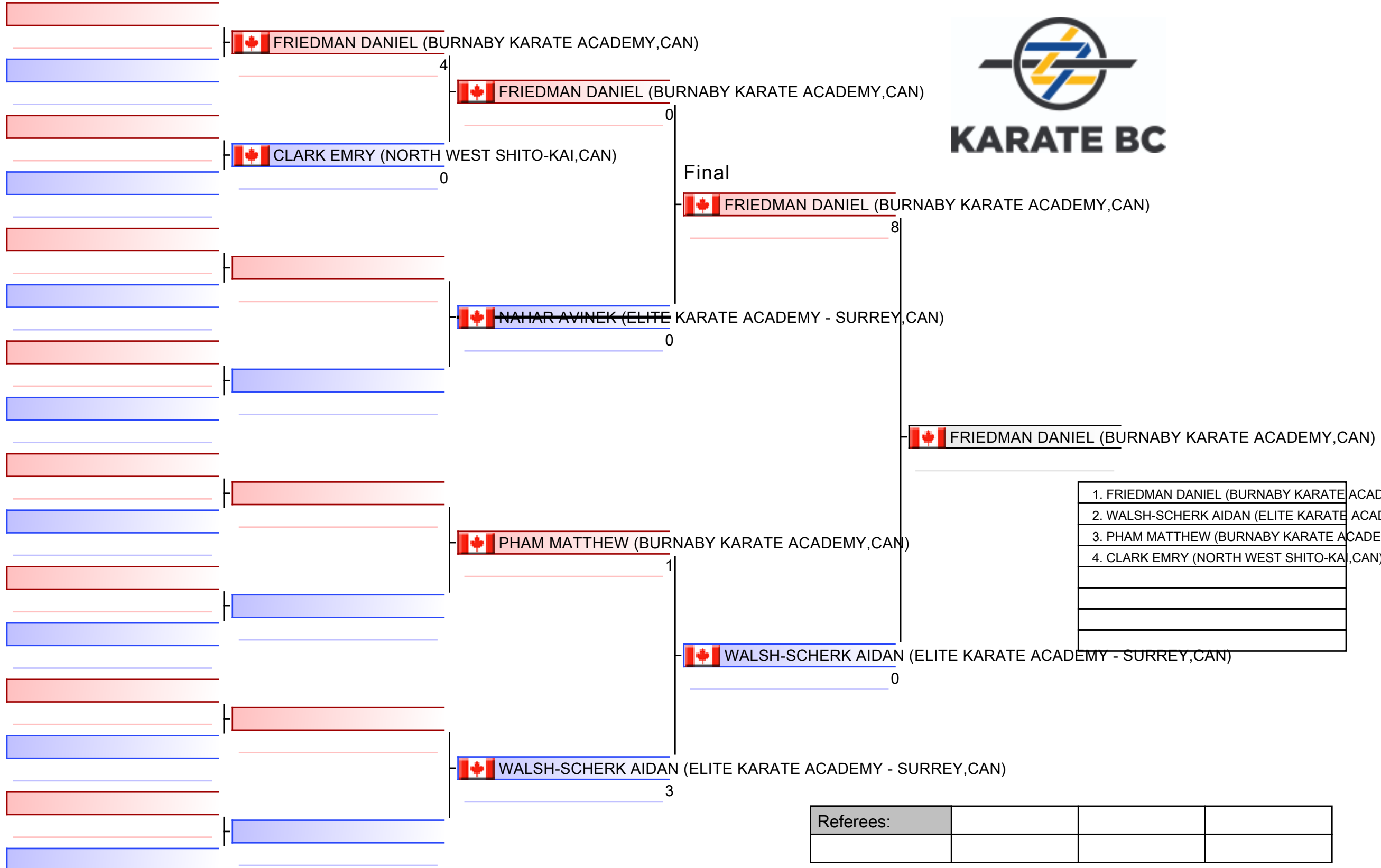

ES-29 Male Youth (12/13) Kumite +55kg

2019 Karate BC Provincial Championships

Tatami
4 12:40

Pool
1

(c)sportdata GmbH & Co KG 2000-2019(2019-12-04 00:07) -WKF Approved- v 9.8.6 build 2 License: Karate BC (expire 2020-10-12)

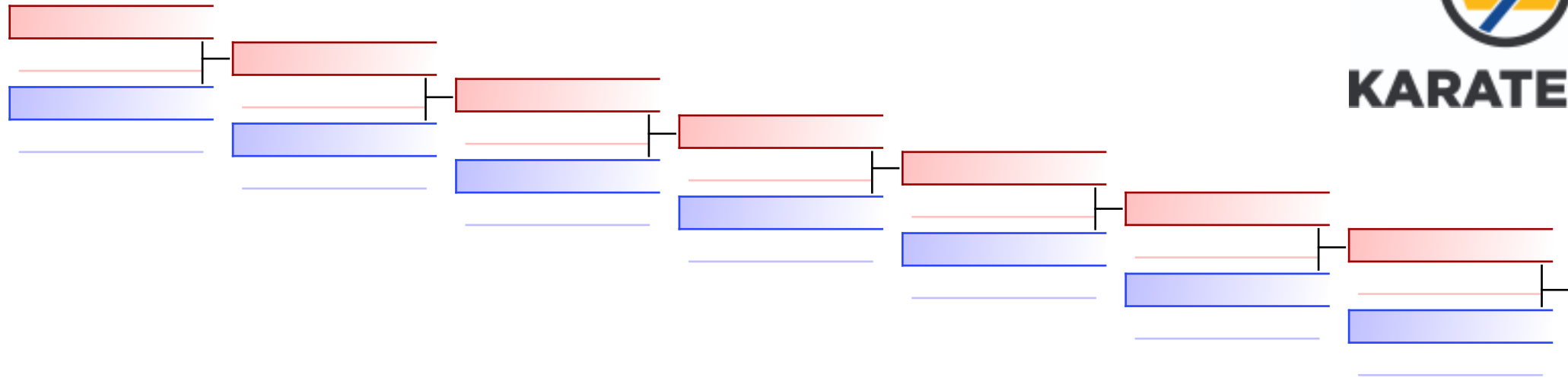

REPECHAGE: (1)

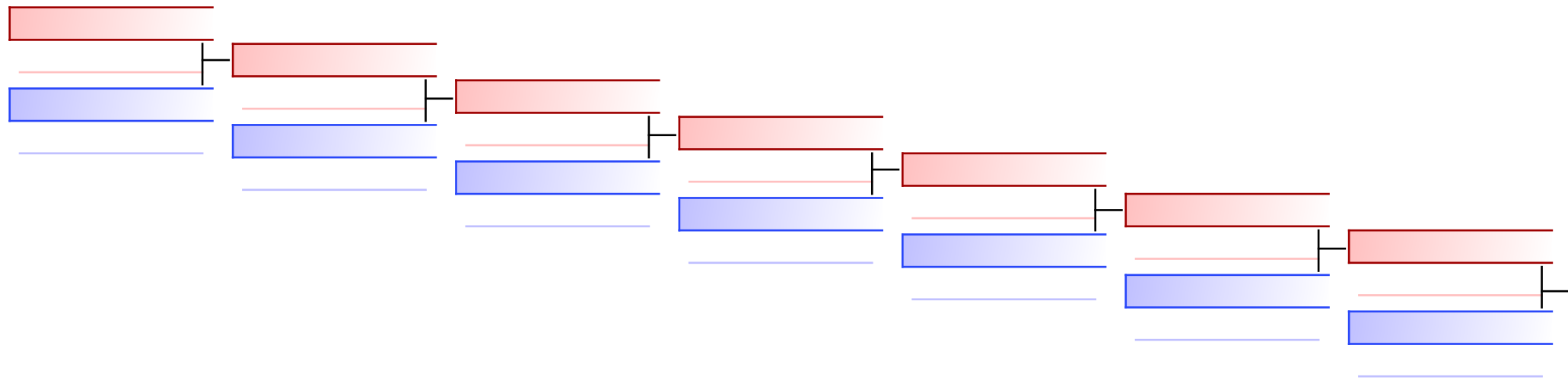

 CLARK EMRY (NORTH WEST SH)
1

 PHAM MATTHEW (BURNABY KA)

 PHAM MATTHEW (BURNABY KA)
2

Referees:							
-----------	--	--	--	--	--	--	--

ES-30 Male Cadet (14/15) Kumite -52kg

2019 Karate BC Provincial Championships, CAN

Tatami
1 14:20

Pool
1/1

 KHAZAENI MICHAEL (TIGERS EYE KARATE-DO NORTH SHORE,CAN)

0  HASSAN JULIAN (WEST VAN KARATE ACADEMY,CAN)

 HASSAN JULIAN (WEST VAN KARATE ACADEMY,CAN)

4  HASSAN JULIAN (WEST VAN KARATE ACADEMY,CAN)

 SHARMA RISHI (BURNABY KARATE ACADEMY,CAN)

1

 FIELD NOLAN (NORTH WEST SHITO-KAI,CAN)

0

 JOHAL KARMVEER (ELITE KARATE ACADEMY - SURREY,CAN)

4

 WYNNE JADE (RODNEY HOBSON KARATE ACADEMY,CAN)

6  WYNNE JADE (RODNEY HOBSON KARATE ACADEMY,CAN)

 JANGRA KARAN (KIMNIK SHOTOKAN KARATE ACADEMY,CAN)

0  ANANDKUMAR VIKRANT (STEVESTON KARATE CLUB,CAN)

 ANANDKUMAR VIKRANT (STEVESTON KARATE CLUB,CAN)

7

 HAFTLANG NIAYESH (TIGERS EYE KARATE-DO NORTH SHORE,CAN)

0

 RAE MICHAEL (BURNABY KARATE ACADEMY,CAN)

0

 RAE MICHAEL (BURNABY KARATE ACADEMY,CAN)

4



Final

 HASSAN JULIAN (WEST VAN KARATE ACADEMY,CAN)

3

 JOHAL KARMVEER (ELITE KARATE ACADEMY - SURREY,CAN)

0

 HASSAN JULIAN (WEST VAN KARATE ACADEMY,CAN)

- | |
|--|
| 1. HASSAN JULIAN (WEST VAN KARATE ACADEMY,CAN) |
| 2. ANANDKUMAR VIKRANT (STEVESTON KARATE CLUB,CAN) |
| 3. WYNNE JADE (RODNEY HOBSON KARATE ACADEMY,CAN) |
| 4. SHARMA RISHI (BURNABY KARATE ACADEMY,CAN) |
| 5. RAE MICHAEL (BURNABY KARATE ACADEMY,CAN) |
| 5. JOHAL KARMVEER (ELITE KARATE ACADEMY - SURREY,CAN) |
| 7. KHAZAENI MICHAEL (TIGERS EYE KARATE-DO NORTH SHORE,CAN) |

 ANANDKUMAR VIKRANT (STEVESTON KARATE CLUB,CAN)

2

Referees:			

ES-30 Male Cadet (14/15) Kumite -52kg

2019 Karate BC Provincial Championships

(c)sportdata GmbH & Co KG 2000-2019(2019-12-04 00:08) -WKF Approved- v 9.8.6 build 2 License: Karate BC (expire 2020-10-12)

Tatami
1 15:05

Pool
1

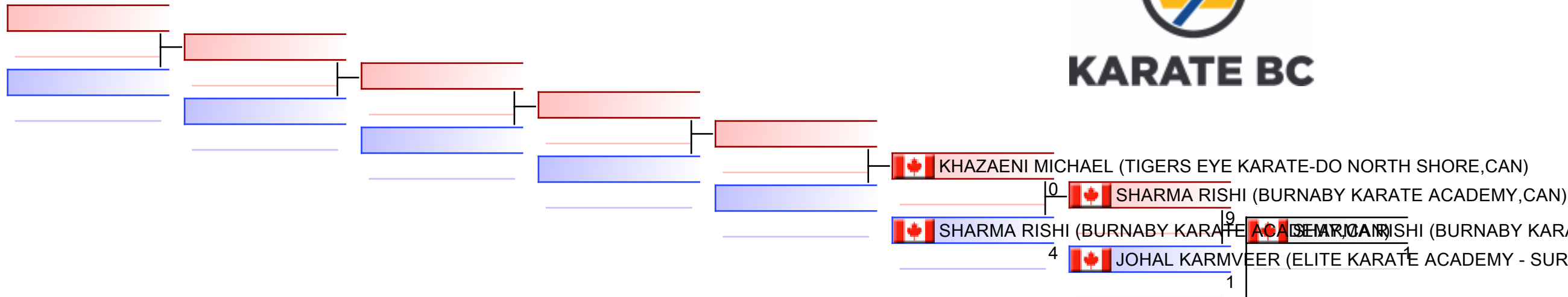

REPECHAGE: (1)

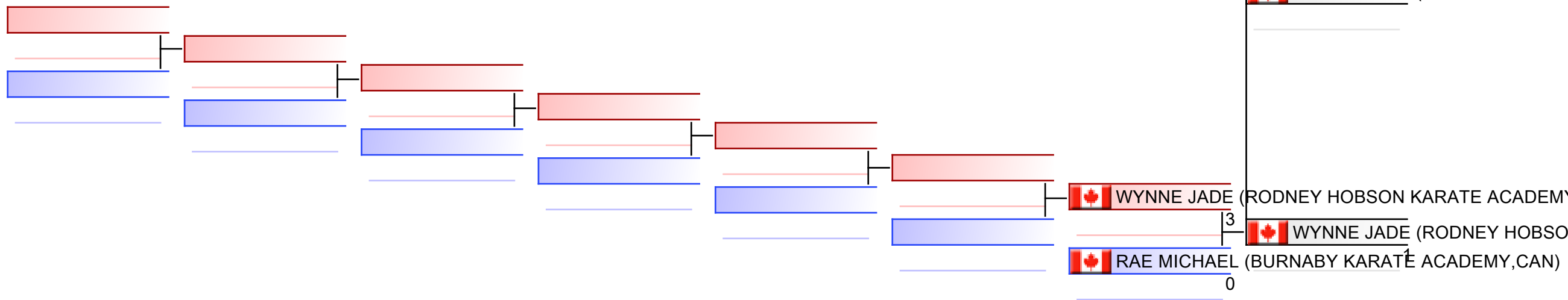

Referees:							
-----------	--	--	--	--	--	--	--

ES-31 Male Cadet (14/15) Kumite -57kg

2019 Karate BC Provincial Championships, CAN

Tatami
4 14:00

Pool
1/1

 SPUR BRAYDEN (WEST RIVER,CAN)

8  SPUR BRAYDEN (WEST RIVER,CAN)

 TASLICAY EGE (TIGERS EYE KARATE-DO NORTH SHORE,CAN)

0  SPUR BRAYDEN (WEST RIVER,CAN)

 BAERG DAMON (SHIMA KARATE SCHOOL - NANAIMO,CAN)

2  PAREJA EZEKIEL (BURNABY KARATE ACADEMY,CAN)

 PAREJA EZEKIEL (BURNABY KARATE ACADEMY,CAN)

3  PAREJA EZEKIEL (BURNABY KARATE ACADEMY,CAN)

 SHARMA ANEESH (WEST RIVER,CAN)

0

 JOSS JAMES (KIMNIK SHOTOKAN KARATE ACADEMY,CAN)

2  JOSS JAMES (KIMNIK SHOTOKAN KARATE ACADEMY,CAN)

 KNICKLE ALEXANDER (WEST VAN KARATE ACADEMY,CAN)

1  TAHERKHANI TAHA (TIGERS EYE KARATE-DO NORTH SHORE,CAN)

 TAHERKHANI TAHA (TIGERS EYE KARATE-DO NORTH SHORE,CAN)

1  DHALIWAL ROHIN (BURNABY KARATE ACADEMY,CAN)

 DHALIWAL ROHIN (BURNABY KARATE ACADEMY,CAN)

5  DHALIWAL ROHIN (BURNABY KARATE ACADEMY,CAN)

 NAKAJIMA KAICHI (WEST RIVER,CAN)

1



Final

 PAREJA EZEKIEL (BURNABY KARATE ACADEMY,CAN)

 PAREJA EZEKIEL (BURNABY KARATE ACADEMY,CAN)

1. PAREJA EZEKIEL (BURNABY KARATE ACADEMY,CAN)
2. DHALIWAL ROHIN (BURNABY KARATE ACADEMY,CAN)
3. SPUR BRAYDEN (WEST RIVER,CAN)
4. NAKAJIMA KAICHI (WEST RIVER,CAN)
5. SHARMA ANEESH (WEST RIVER,CAN)
5. TAHERKHANI TAHA (TIGERS EYE KARATE-DO NORTH SHORE,CAN)

Referees:			

ES-31 Male Cadet (14/15) Kumite -57kg

2019 Karate BC Provincial Championships

(c)sportdata GmbH & Co KG 2000-2019(2019-12-04 00:08) -WKF Approved- v 9.8.6 build 2 License: Karate BC (expire 2020-10-12)

Tatami
4 14:45

Pool
1

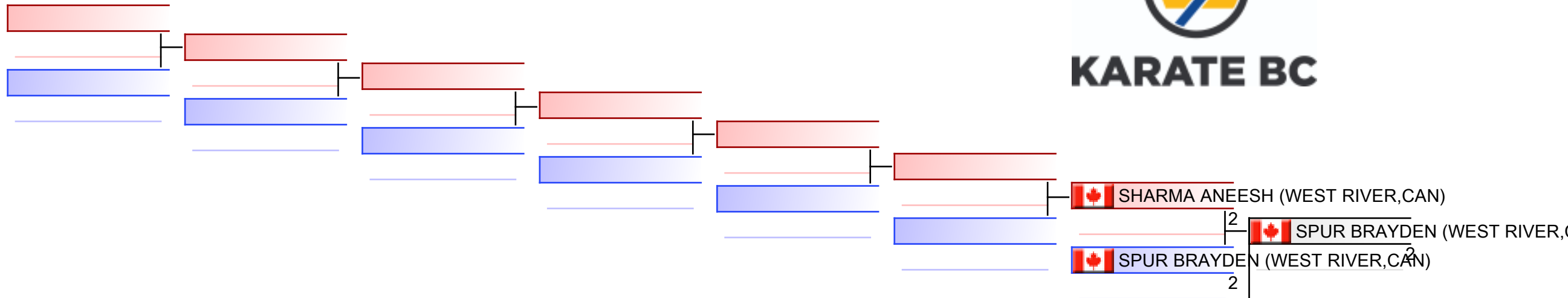

REPECHAGE: (1)

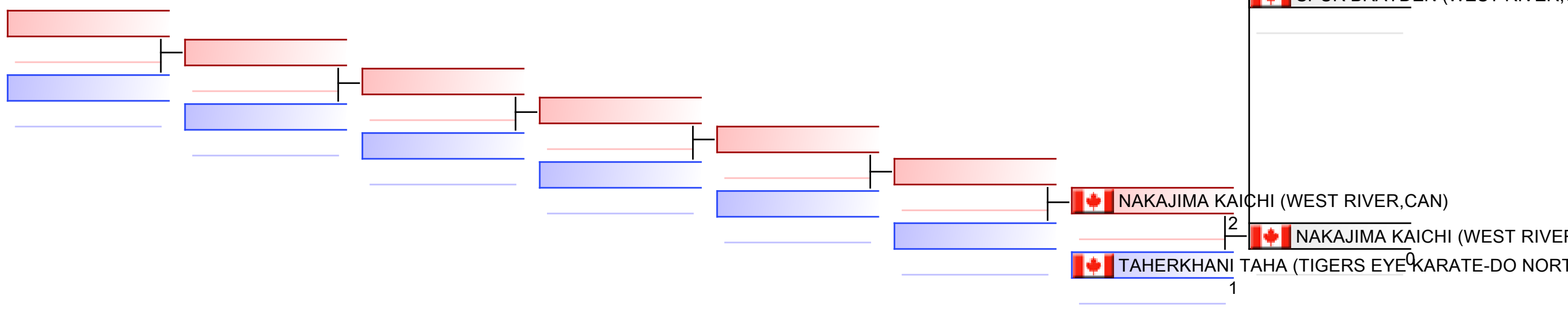

Referees:							
-----------	--	--	--	--	--	--	--

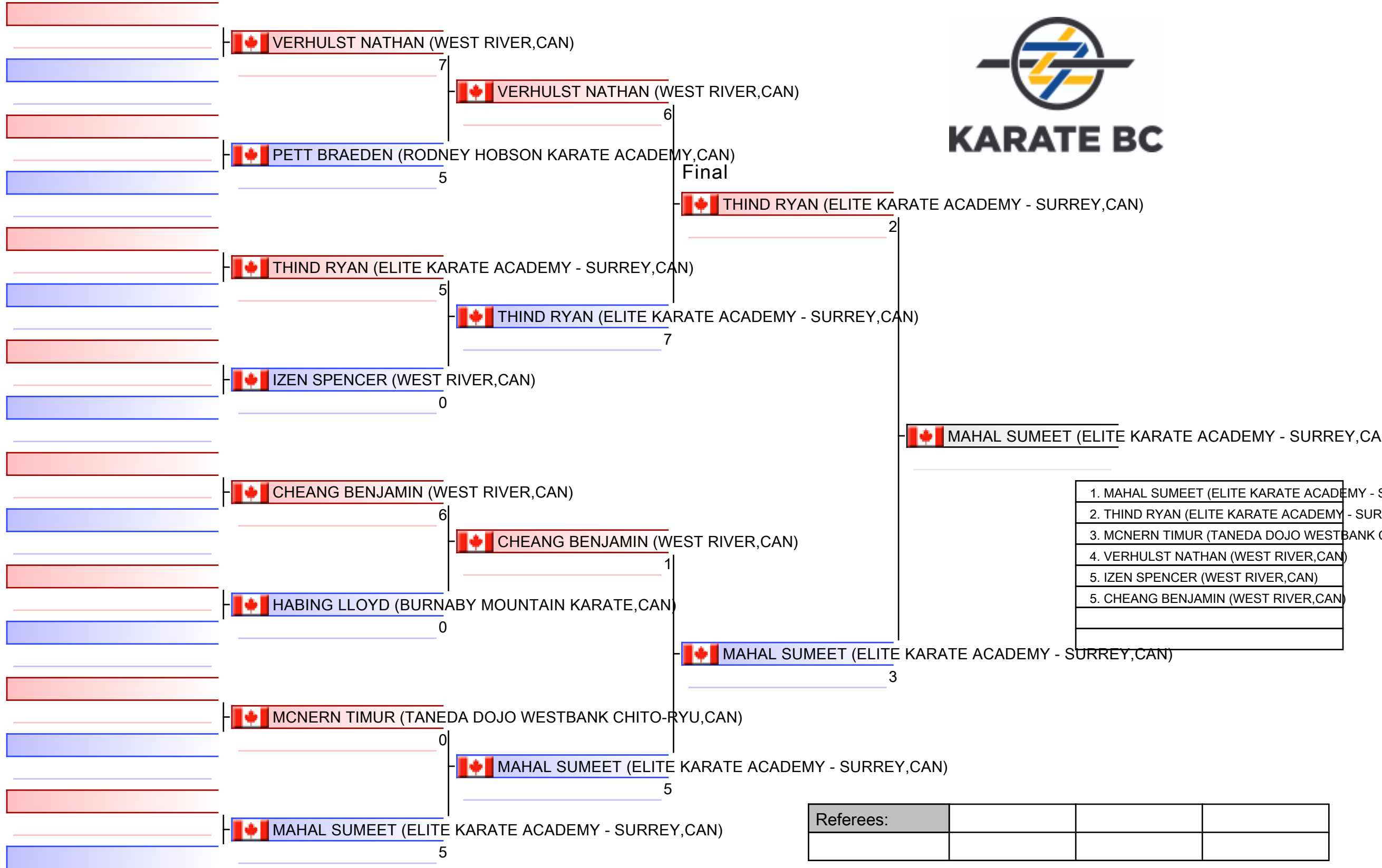

Referees:			

ES-32 Male Cadet (14/15) Kumite -63kg

2019 Karate BC Provincial Championships

(c)sportdata GmbH & Co KG 2000-2019(2019-12-04 00:08) -WKF Approved- v 9.8.6 build 2 License: Karate BC (expire 2020-10-12)

Tatami
3 15:50

Pool
1

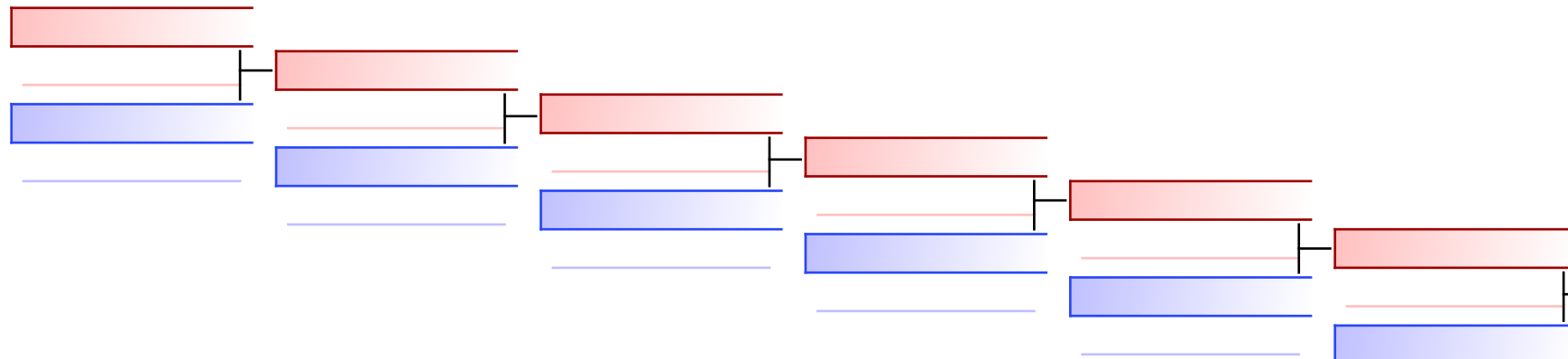

IZEN SPENCER (WEST RIVER,CAN)

VERHULST NATHAN (WEST RIVER,CAN)

VERHULST NATHAN (WEST RIVER,CAN)

MCNERN TIMUR (TANEDA DOJO WESTBANK CHITO-)

REPECHAGE: (1)

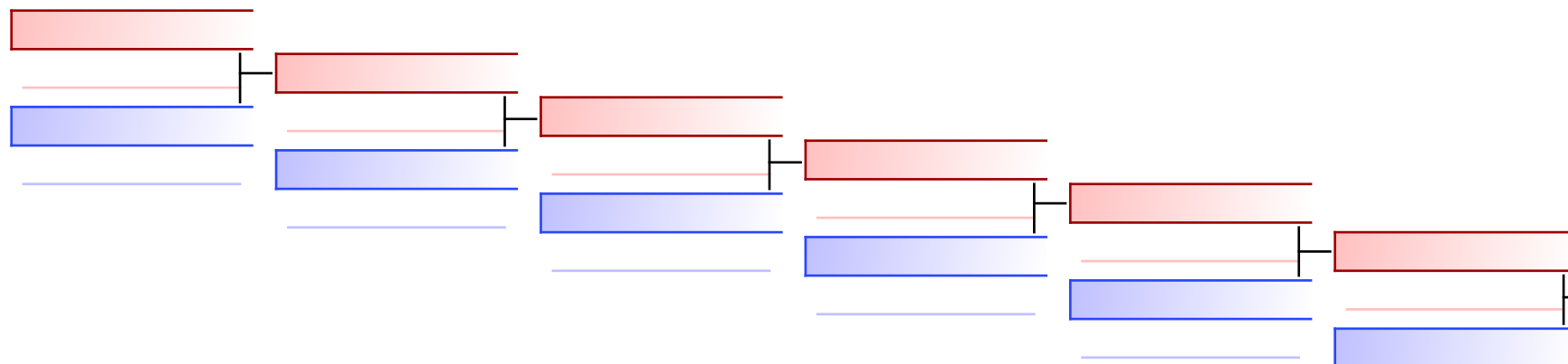

MCNERN TIMUR (TANEDA DOJO WESTBANK CHITO-)

MCNERN TIMUR (TANEDA DOJO WESTBANK CHITO-)

CHEANG BENJAMIN (WEST RIVER,CAN)

MCNERN TIMUR (TANEDA DOJO WESTBANK CHITO-)

Referees:							
-----------	--	--	--	--	--	--	--

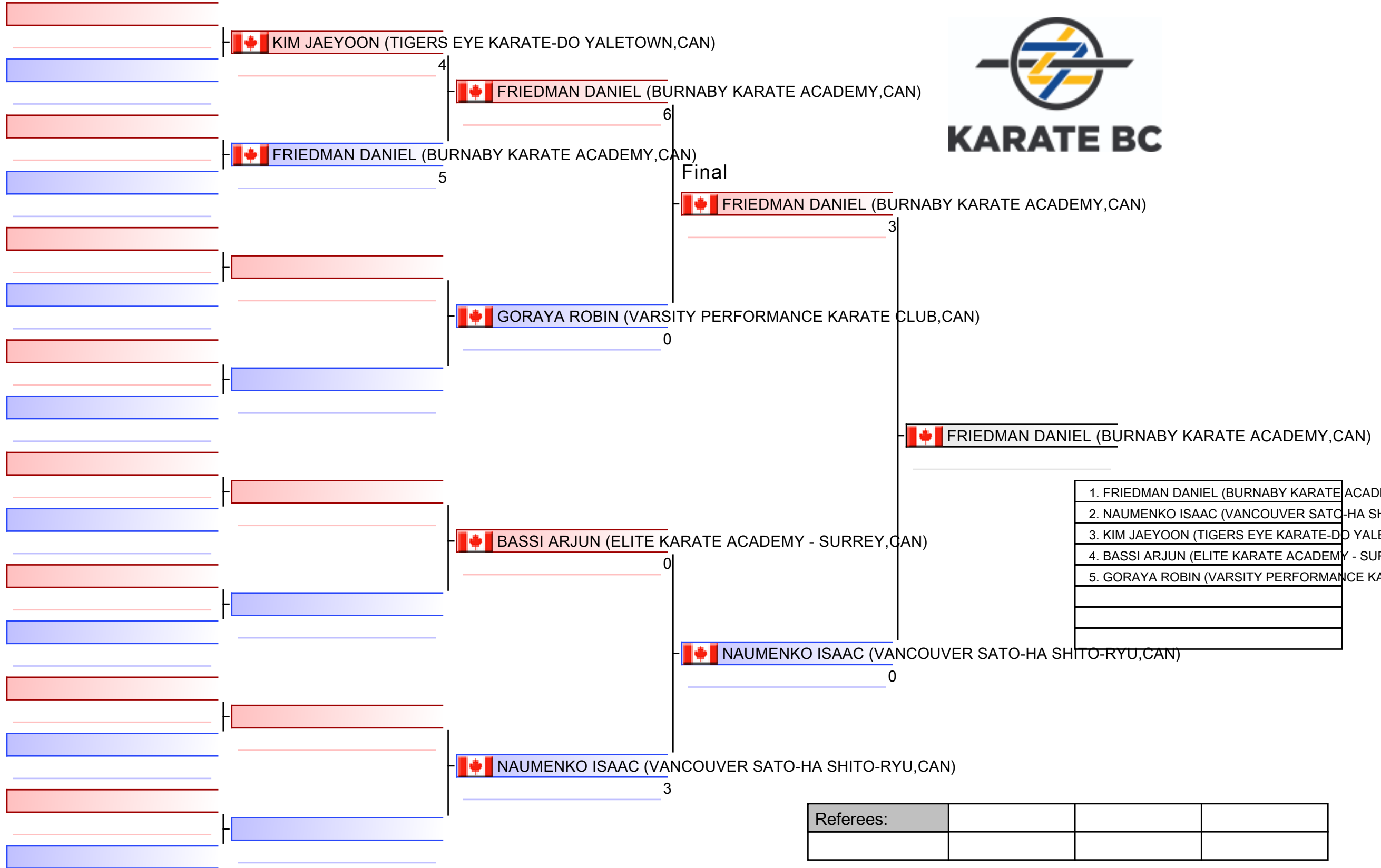

ES-33 Male Cadet (14/15) Kumite -70kg

2019 Karate BC Provincial Championships

Tatami
4 15:45

Pool
1

(c)sportdata GmbH & Co KG 2000-2019(2019-12-04 00:08) -WKF Approved- v 9.8.6 build 2 License: Karate BC (expire 2020-10-12)

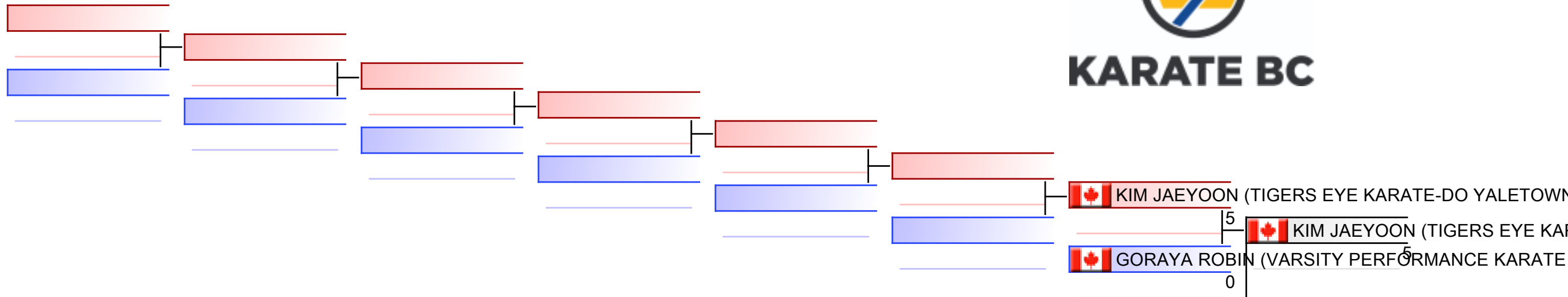

REPECHAGE: (1)

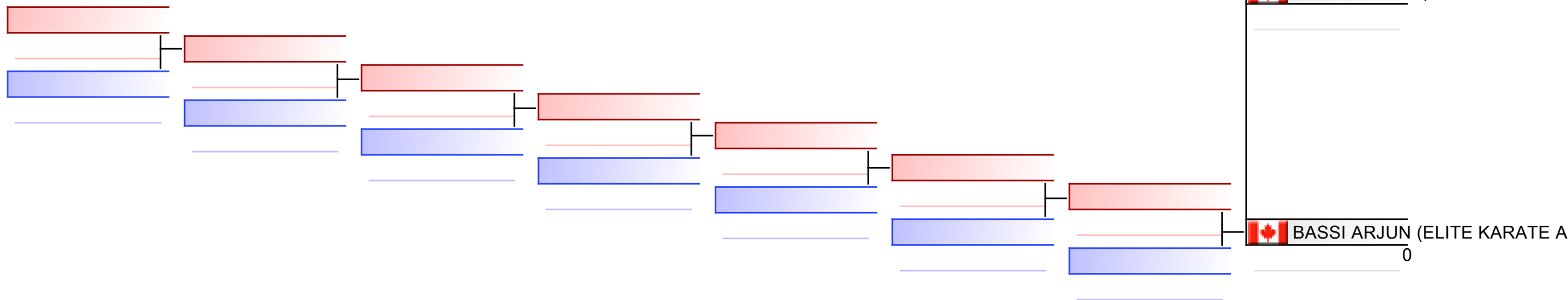

Referees:							
-----------	--	--	--	--	--	--	--

ES-34 Male Cadet (14/15) Kumite +70kg

2019 Karate BC Provincial Championships, CAN

Tatami
2 15:00

Pool
1/1

 RUBAYI SHEJA (BURNABY KARATE ACADEMY,CAN)

8

 RUBAYI SHEJA (BURNABY KARATE ACADEMY,CAN)

 KAMBO ARVIN (ELITE KARATE ACADEMY - SURREY,CAN)

1

 RUBAYI SHEJA (BURNABY KARATE ACADEMY,CAN)

8

 FELDMAN ALEX (KIMNIK SHOTOKAN KARATE ACADEMY,CAN)

Final

 RUBAYI SHEJA (BURNABY KARATE ACADEMY,CAN)

5

 KALKAT PARJOT_SINGH (ELITE KARATE ACADEMY - SURREY,CAN)

3

 DAVIS JAYDON (TANEDA DOJO SUMMERLAND CHITO-RYU,CAN)

0

 DAVIS JAYDON (TANEDA DOJO SUMMERLAND CHITO-RYU,CAN)

4

 RUBAYI SHEJA (BURNABY KARATE ACADEMY,CAN)

 BAYBEN THEODORE (KINGSWAY SHITO-RYU,CAN)

3

 BAYBEN THEODORE (KINGSWAY SHITO-RYU,CAN)

6

 SAHOTA BHAVRAJ (ELITE KARATE ACADEMY - SURREY,CAN)

1

 BAYBEN THEODORE (KINGSWAY SHITO-RYU,CAN)

0

 SPROWSON SAMUEL (WEST VAN KARATE ACADEMY,CAN)

4

 HOWARD KENTAROU (BURNABY CHITO RYU YUSEIKAN,CAN)

0

 HOWARD KENTAROU (BURNABY CHITO RYU YUSEIKAN,CAN)

8



1. RUBAYI SHEJA (BURNABY KARATE ACADEMY)
2. BAYBEN THEODORE (KINGSWAY SHITO-RYU,CAN)
3. HOWARD KENTAROU (BURNABY CHITO RYU YUSEIKAN,CAN)
4. DAVIS JAYDON (TANEDA DOJO SUMMERLAND CHITO-RYU,CAN)
5. KAMBO ARVIN (ELITE KARATE ACADEMY - SURREY,CAN)
6. SAHOTA BHAVRAJ (ELITE KARATE ACADEMY - SURREY,CAN)

Referees:			

ES-34 Male Cadet (14/15) Kumite +70kg

2019 Karate BC Provincial Championships

(c)sportdata GmbH & Co KG 2000-2019(2019-12-04 00:08) -WKF Approved- v 9.8.6 build 2 License: Karate BC (expire 2020-10-12)

Tatami
2 15:40

Pool
1

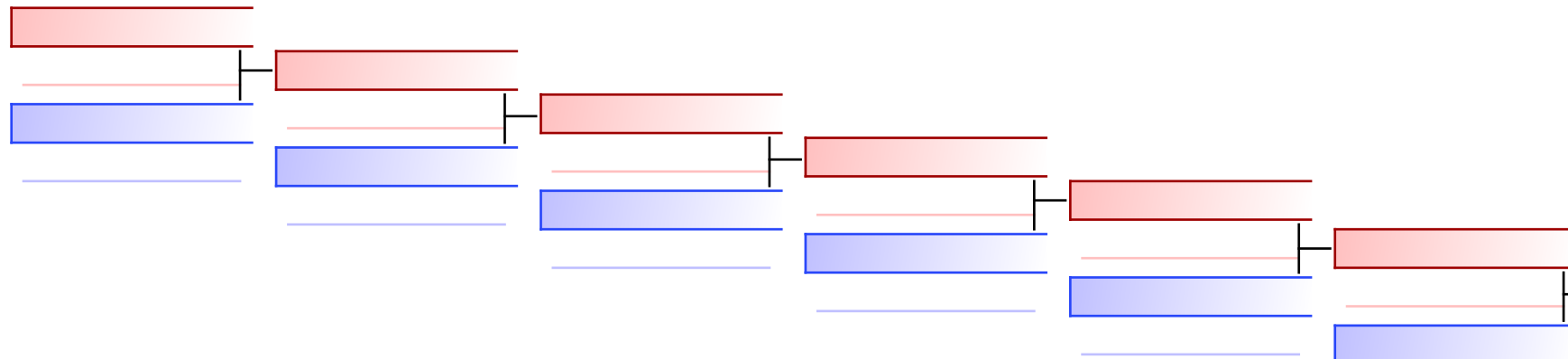

KAMBO ARVIN (ELITE KARATE ACADEMY - SURREY) 4
 DAVIS JAYDON (TANEDA DOJO SUMMERLAND CHIT) 6
 DAVIS JAYDON (TANEDA DOJO SUMMERLAND CHIT) 6

REPECHAGE: (1)

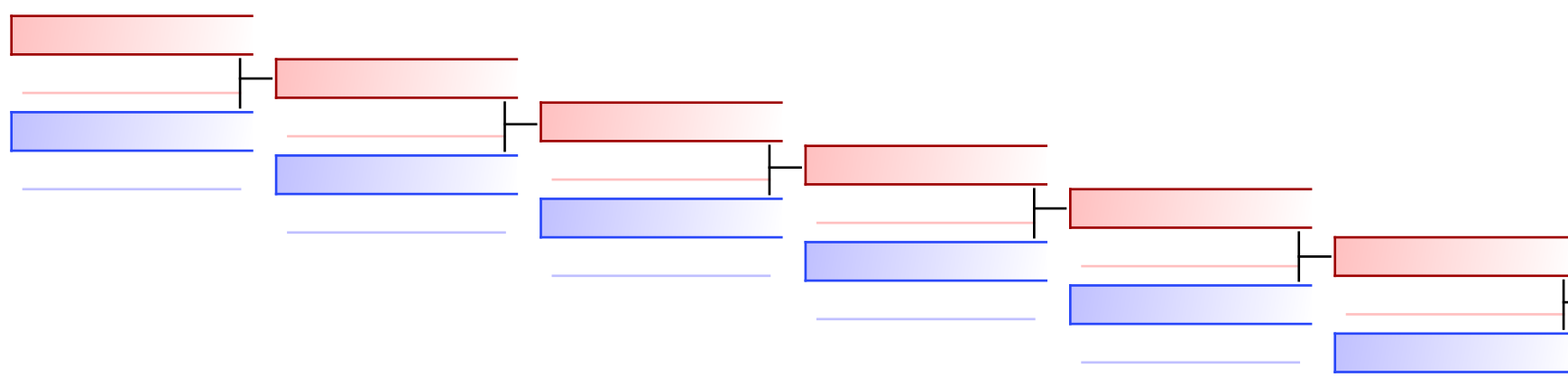

HOWARD KENTAROU (BURNABY) 6
 SAHOTA BHAVRAJ (ELITE KARATE ACADEMY - SUR) 6
 HOWARD KENTAROU (BURNABY) 6
 HOWARD KENTAROU (BURNABY) 7
 HOWARD KENTAROU (BURNABY) 7









Referees:							
-----------	--	--	--	--	--	--	--

ES-35 Male Junior (16/17) Kumite -55kg - Round Robin (each against each)

2019 Karate BC Provincial Championships, CAN

Tatami
3 16:10

Pool
1/1

- 1  YOUSEFI_FARID FARZAN (TIGERS EYE KARATE-DO NORTH SHORE,CAN)
0 |  TAMURA RIKUTO (WEST VAN KARATE ACADEMY,CAN)
- 2  TAMURA RIKUTO (WEST VAN KARATE ACADEMY,CAN)
4
- 3  YOUSEFI_FARID FARZAN (TIGERS EYE KARATE-DO NORTH SHORE,CAN)
2 |  SZETO CONNOR (WEST VAN KARATE ACADEMY,CAN)
- 4  SZETO CONNOR (WEST VAN KARATE ACADEMY,CAN)
5
- 5  TAMURA RIKUTO (WEST VAN KARATE ACADEMY,CAN)
1 |  SZETO CONNOR (WEST VAN KARATE ACADEMY,CAN)
- 6  SZETO CONNOR (WEST VAN KARATE ACADEMY,CAN)
2



1.	SZETO CONNOR (WEST VAN KARATE ACADEMY,CAN)
2.	TAMURA RIKUTO (WEST VAN KARATE ACADEMY,CAN)
3.	YOUSEFI_FARID FARZAN (TIGERS EYE KARATE-DO NORTH SHORE,CAN)

Referees:			

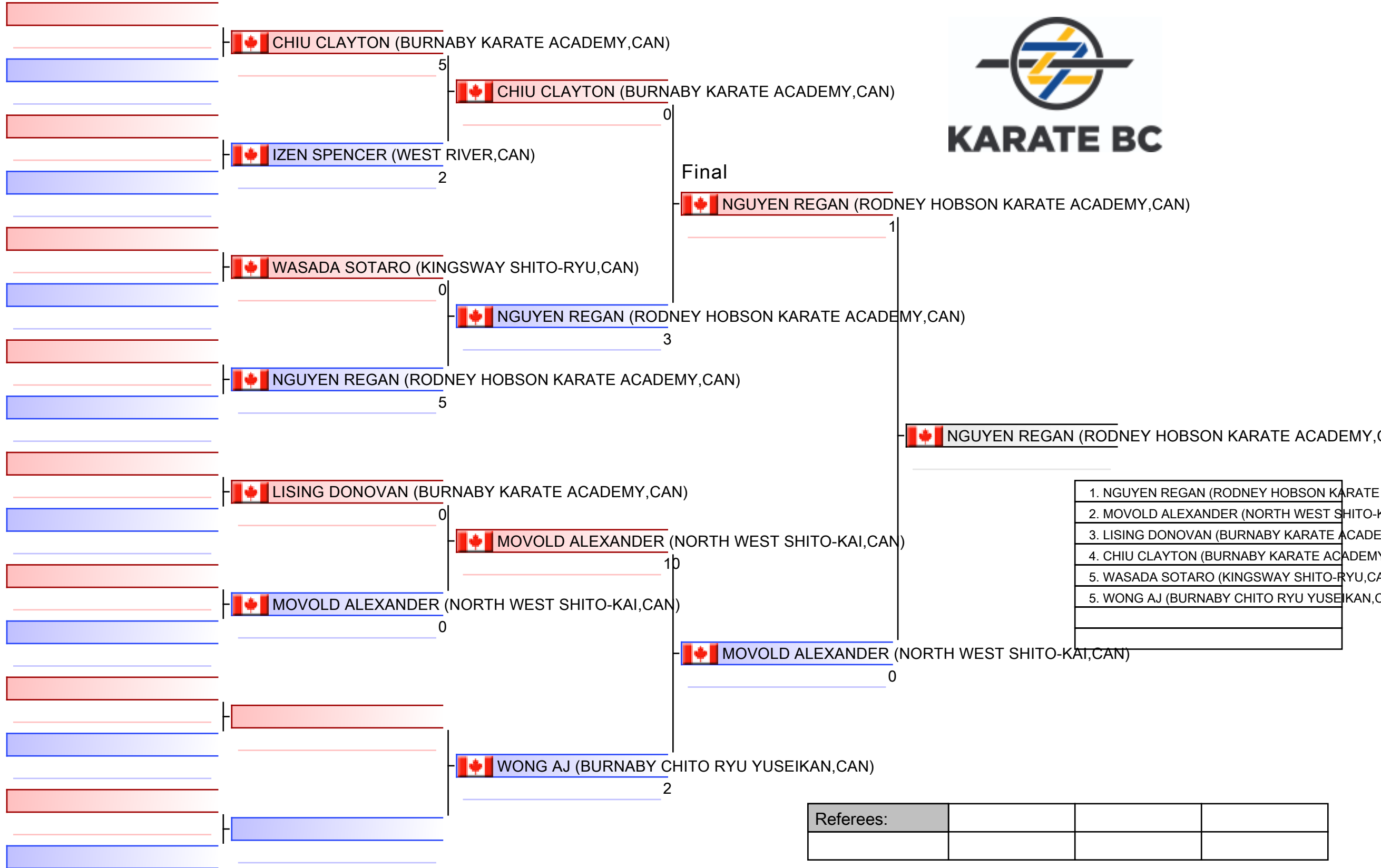

- | |
|--|
| 1. NGUYEN REGAN (RODNEY HOBSON KARATE ACADEMY,CAN) |
| 2. MOVOLD ALEXANDER (NORTH WEST SHITO-KAI,CAN) |
| 3. LISING DONOVAN (BURNABY KARATE ACADEMY,CAN) |
| 4. CHIUI CLAYTON (BURNABY KARATE ACADEMY,CAN) |
| 5. WASADA SOTARO (KINGSWAY SHITO-RYU,CAN) |
| 6. WONG AJ (BURNABY CHITO RYU YUSEIKAN,CAN) |
| |
| |

Referees:			

ES-36 Male Junior (16/17) Kumite -61kg

2019 Karate BC Provincial Championships

(c)sportdata GmbH & Co KG 2000-2019(2019-12-04 00:08) -WKF Approved- v 9.8.6 build 2 License: Karate BC (expire 2020-10-12)

Tatami
1 16:05

Pool
1

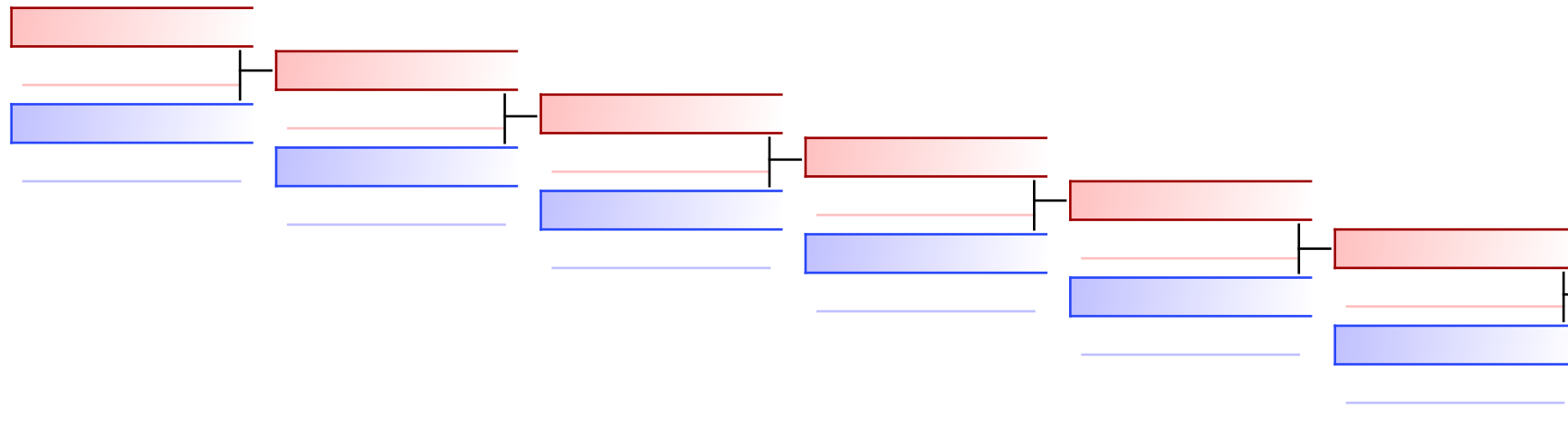

WASADA SOTARO (KINGSWAY SHITO-RYU,CAN)

0 CHIU CLAYTON (BURNABY KARATE ACADEMY,CAN)

CHIU CLAYTON (BURNABY KARATE ACADEMY,CAN)

0

REPECHAGE: (1)

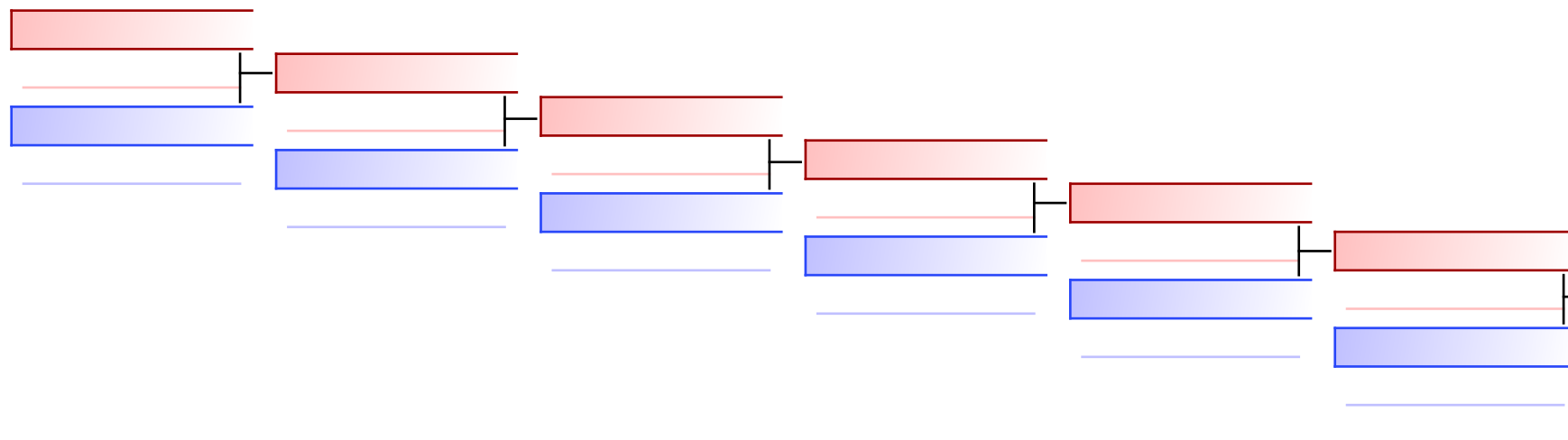

LISING DONOVAN (BURNABY KARATE ACADEMY,CAN)

LISING DONOVAN (BURNABY KARATE ACADEMY,CAN)

5 LISING DONOVAN (BURNABY KARATE ACADEMY,CAN)

WONG AJ (BURNABY CHITO RYU YUSEIKAN,CAN)

2

Referees:							
-----------	--	--	--	--	--	--	--

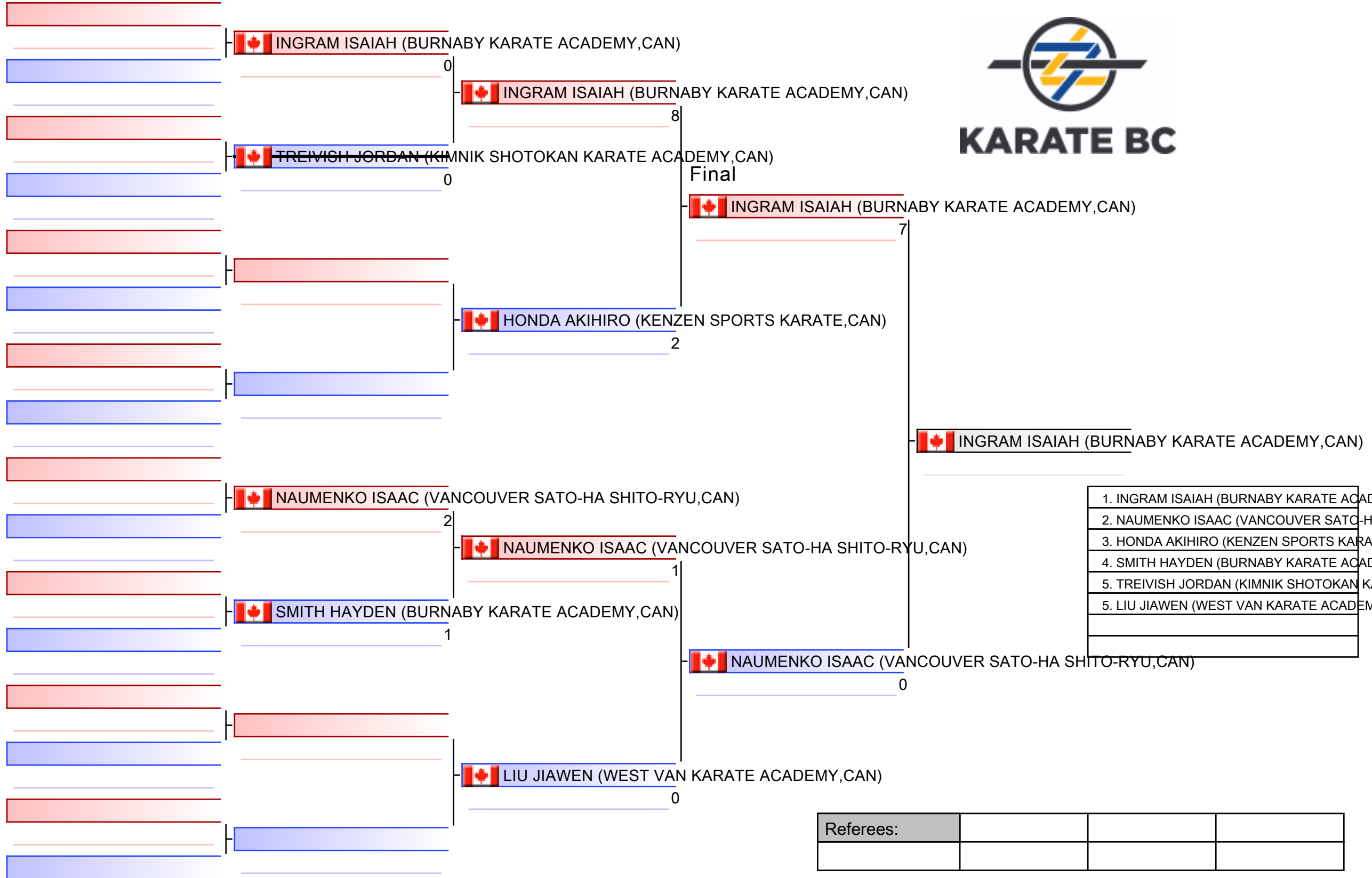

ES-37 Male Junior (16/17) Kumite -68kg

2019 Karate BC Provincial Championships

(c)sportdata GmbH & Co KG 2000-2019(2019-12-04 00:08) -WKF Approved- v 9.8.6 build 2 License: Karate BC (expire 2020-10-12)

Tatami
4 16:35

Pool
1

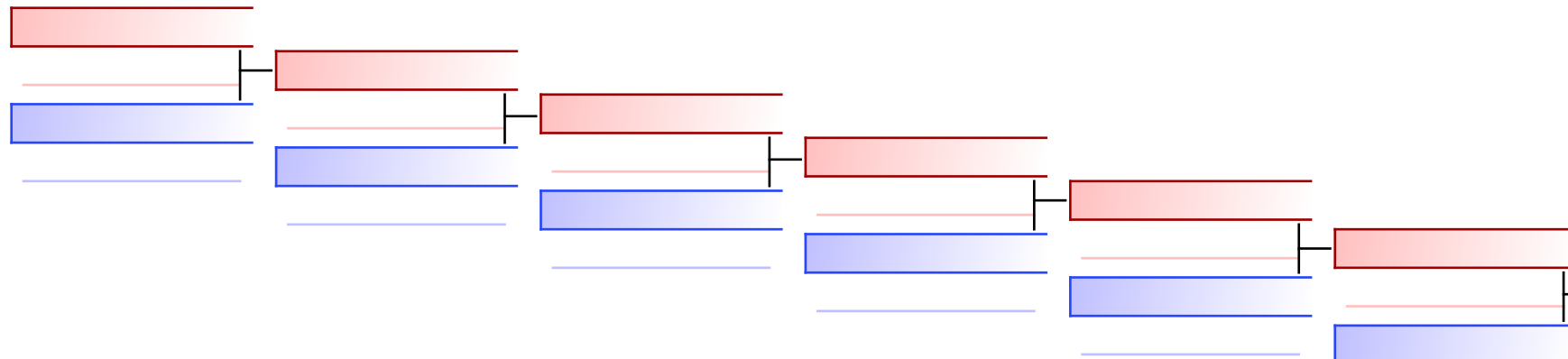

~~TREVISH JORDAN (KIMNIK SHOTOKAN KARATE ACAD, CAN)~~

HONDA AKIHIRO (KENZEN SPORTS KARATE, CAN) 0

HONDA AKIHIRO (KENZEN SPORTS KARATE, CAN) 0

HONDA AKIHIRO (KENZEN SPORTS KARATE, CAN) 0

REPECHAGE: (1)

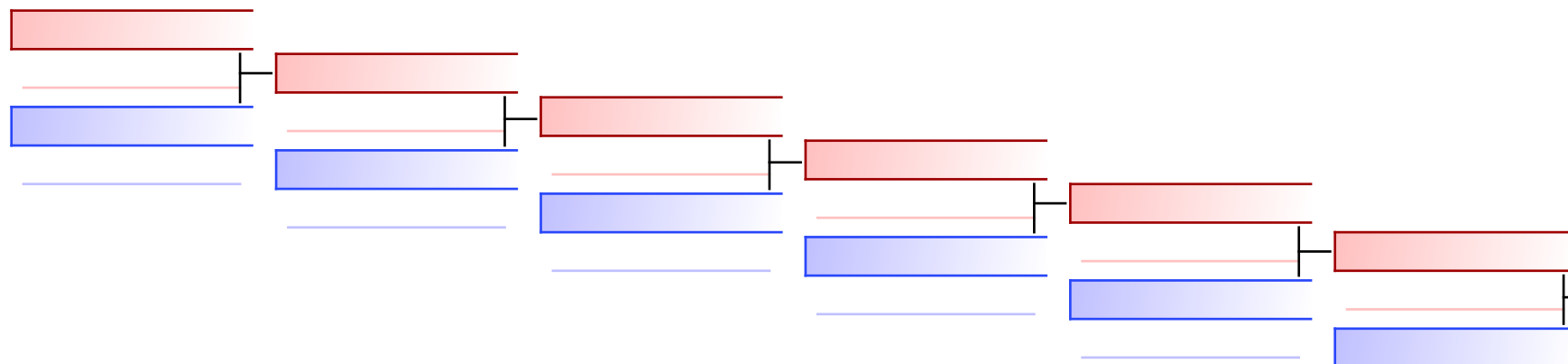

SMITH HAYDEN (BURNABY KARATE ACADEMY, CAN) 4

SMITH HAYDEN (BURNABY KARATE ACADEMY, CAN) 4

LIU JIAWEN (WEST VAN KARATE ACADEMY, CAN) 1

LIU JIAWEN (WEST VAN KARATE ACADEMY, CAN) 0

Referees:							
-----------	--	--	--	--	--	--	--

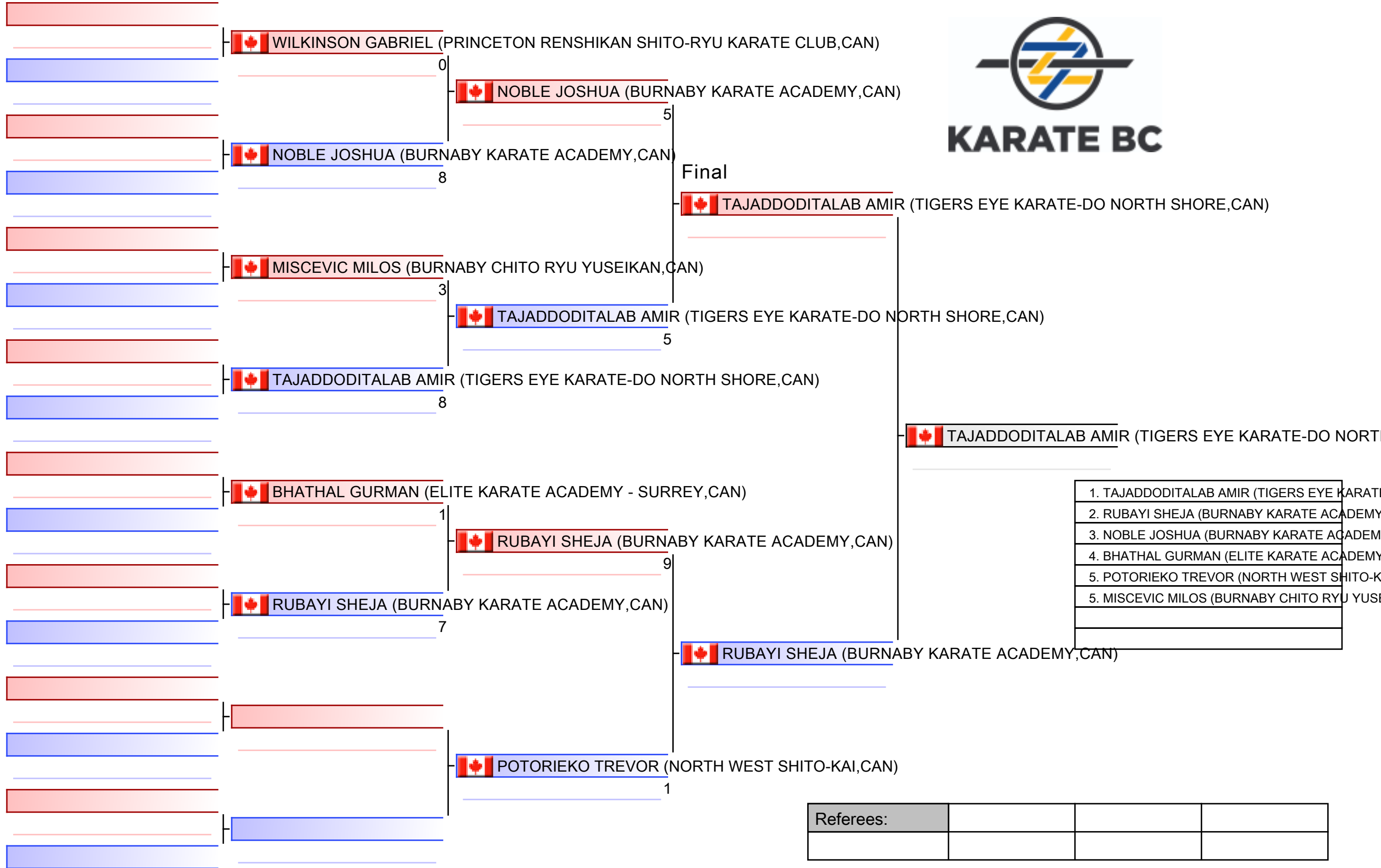

- | |
|--|
| 1. TAJADDODITALAB AMIR (TIGERS EYE KARATE-DO NORTH SHORE, CAN) |
| 2. RUBAYI SHEJA (BURNABY KARATE ACADEMY, CAN) |
| 3. NOBLE JOSHUA (BURNABY KARATE ACADEMY, CAN) |
| 4. BHATHAL GURMAN (ELITE KARATE ACADEMY - SURREY, CAN) |
| 5. POTORIEKO TREVOR (NORTH WEST SHITO-KAI, CAN) |
| 5. MISCEVIC MILOS (BURNABY CHITO RYU YUSEIKAN, CAN) |
| |
| |

Referees:			

ES-38 Male Junior (16/17) Kumite -76kg

2019 Karate BC Provincial Championships

(c)sportdata GmbH & Co KG 2000-2019(2019-12-04 00:08) -WKF Approved- v 9.8.6 build 2 License: Karate BC (expire 2020-10-12)

Tatami
2 16:35

Pool
1

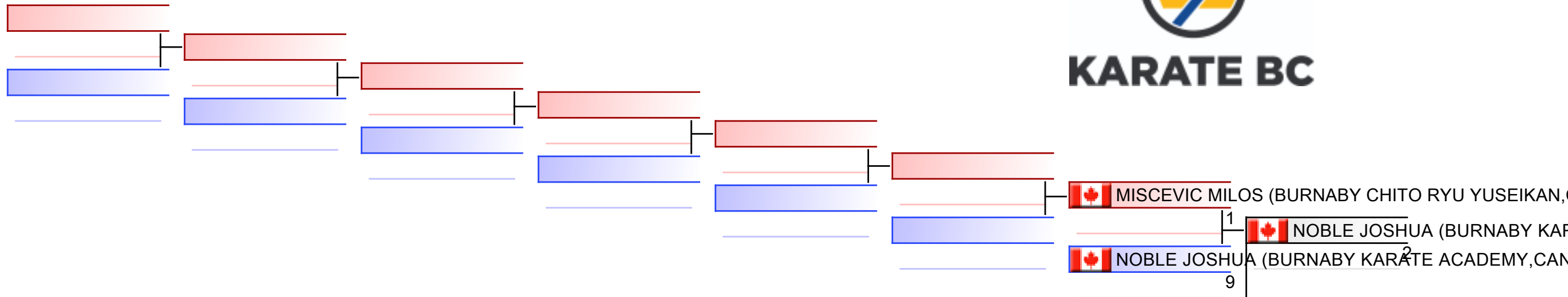

REPECHAGE: (1)

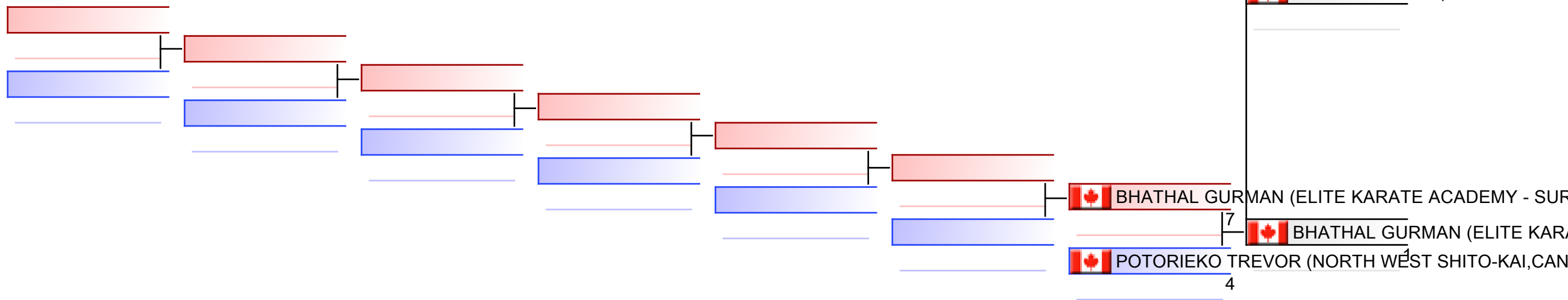

Referees:							
-----------	--	--	--	--	--	--	--



KARATE BC

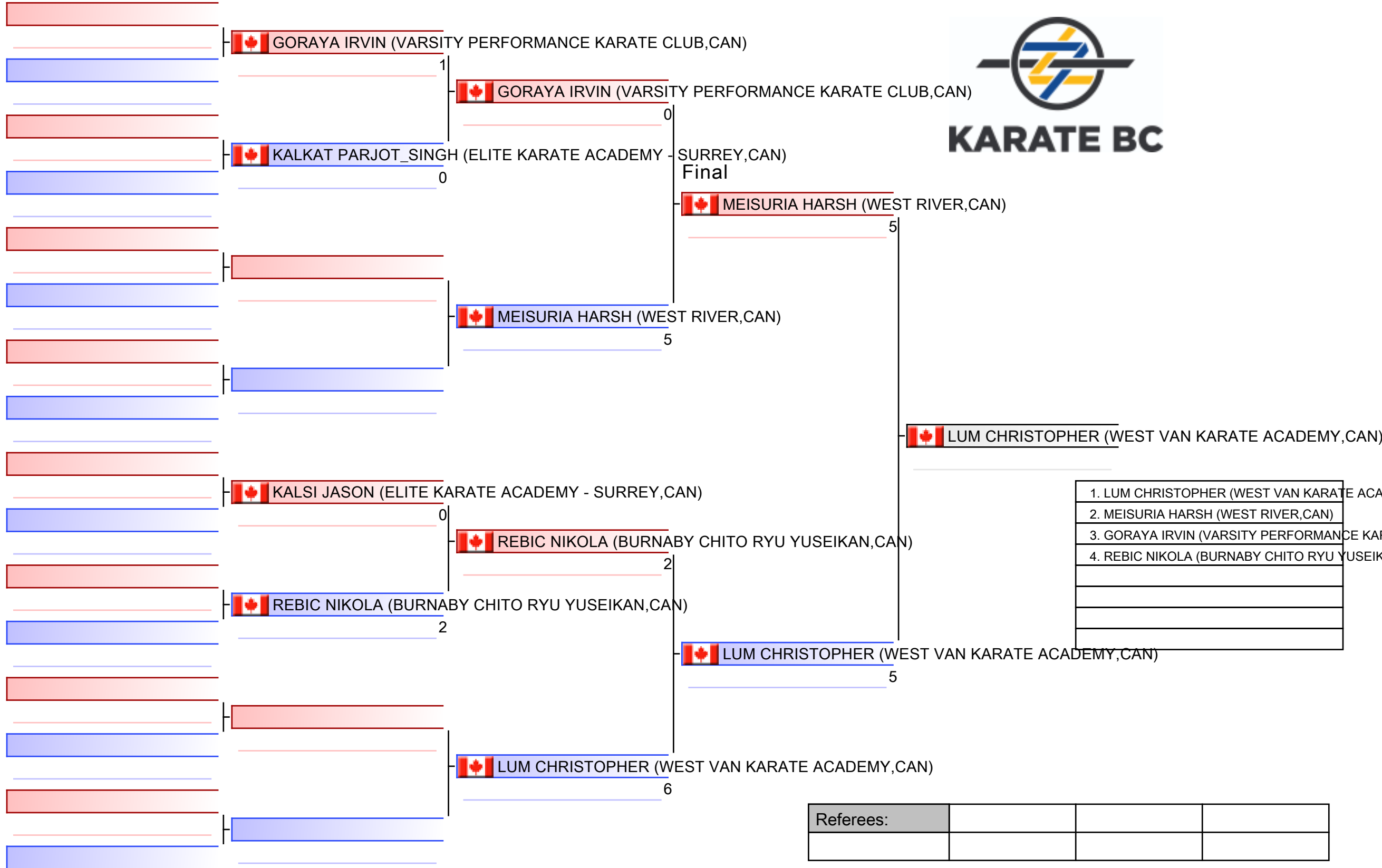

ES-39 Male Junior (16/17) Kumite +76kg

2019 Karate BC Provincial Championships

(c)sportdata GmbH & Co KG 2000-2019(2019-12-04 00:08) -WKF Approved- v 9.8.6 build 2 License: Karate BC (expire 2020-10-12)

Tatami
1 16:45

Pool
1

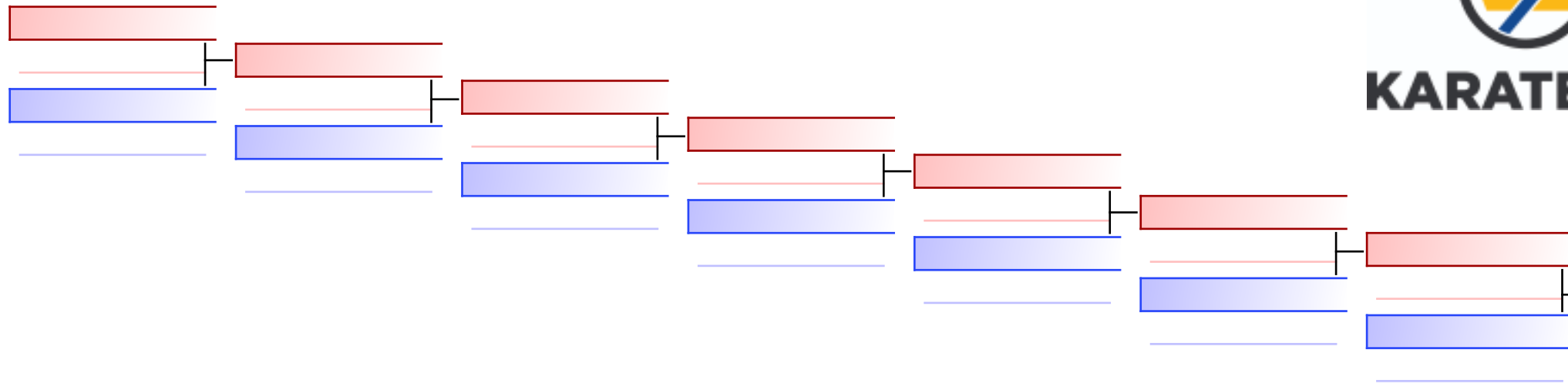

REPECHAGE: (1)

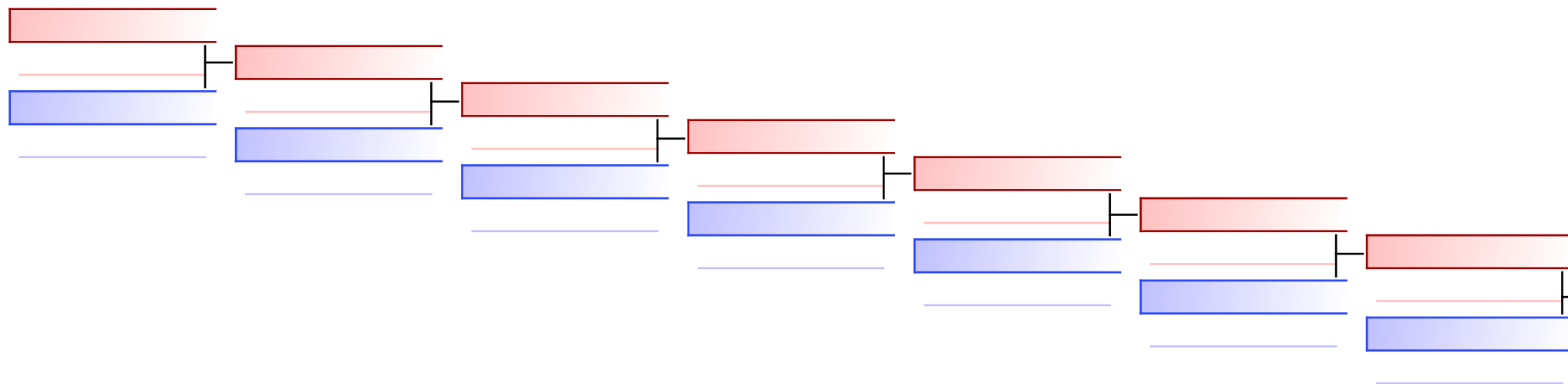

 GORAYA IRVIN (VARSITY PERFO
0

 GORAYA IRVIN (VARSITY PERFO

 REBIC NIKOLA (BURNABY CHIT
0

Referees:							
-----------	--	--	--	--	--	--	--



KARATE BC

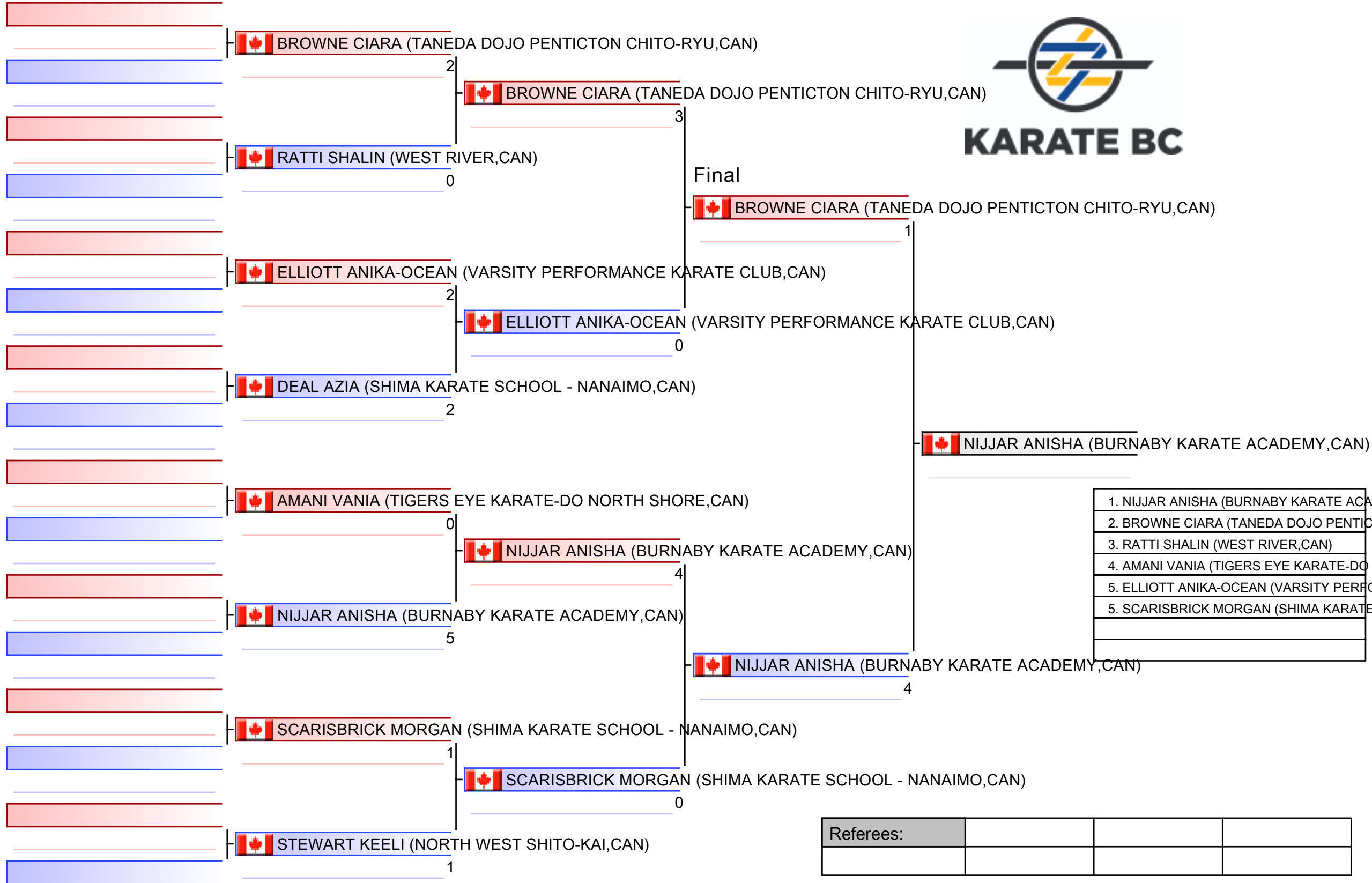

ES-3 Female Youth (12/13) Kumite +47kg

2019 Karate BC Provincial Championships

(c)sportdata GmbH & Co KG 2000-2019(2019-12-04 00:08) -WKF Approved- v 9.8.6 build 2 License: Karate BC (expire 2020-10-12)

Tatami
1 14:00

Pool
1

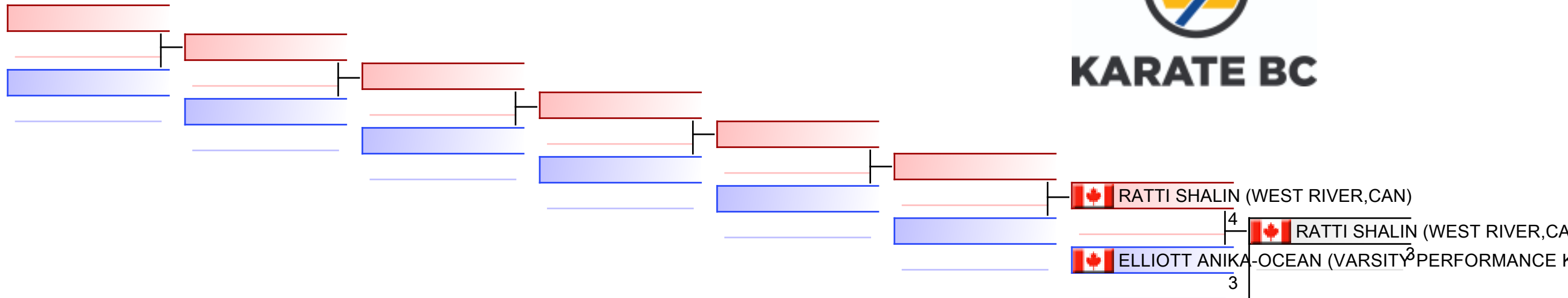

REPECHAGE: (1)

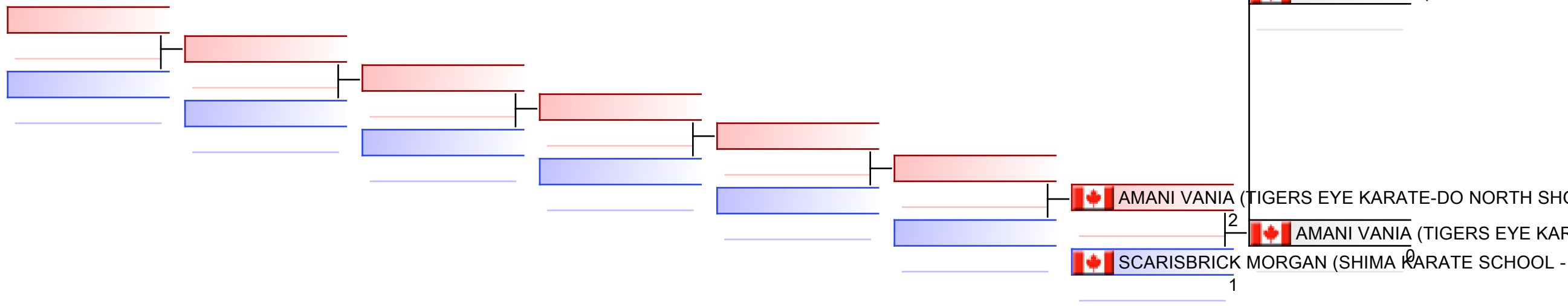









Referees:							
-----------	--	--	--	--	--	--	--

ES-40 Male U21 Kumite -60kg - Round Robin (each against each)

2019 Karate BC Provincial Championships, CAN

Tatami
3 16:25

Pool
1/1

- 1  **PLUNKETT MICHAEL (BURNABY KARATE ACADEMY,CAN)**
9 |  **PLUNKETT MICHAEL (BURNABY KARATE ACADEMY,CAN)**
- 2  **POOLE CARSON (TIGERS EYE KARATE-DO NORTH SHORE,CAN)**
1
- 3  **PLUNKETT MICHAEL (BURNABY KARATE ACADEMY,CAN)**
2 |  **SHARMA PRANAY (ELITE KARATE ACADEMY - SURREY,CAN)**
- 4  **SHARMA PRANAY (ELITE KARATE ACADEMY - SURREY,CAN)**
2
- 5  **POOLE CARSON (TIGERS EYE KARATE-DO NORTH SHORE,CAN)**
4 |  **POOLE CARSON (TIGERS EYE KARATE-DO NORTH SHORE,CAN)**
- 6  **SHARMA PRANAY (ELITE KARATE ACADEMY - SURREY,CAN)**
3



1.	PLUNKETT MICHAEL (BURNABY KARATE ACADEMY,CAN)
2.	POOLE CARSON (TIGERS EYE KARATE-DO NORTH SHORE,CAN)
3.	SHARMA PRANAY (ELITE KARATE ACADEMY - SURREY,CAN)

Referees:			

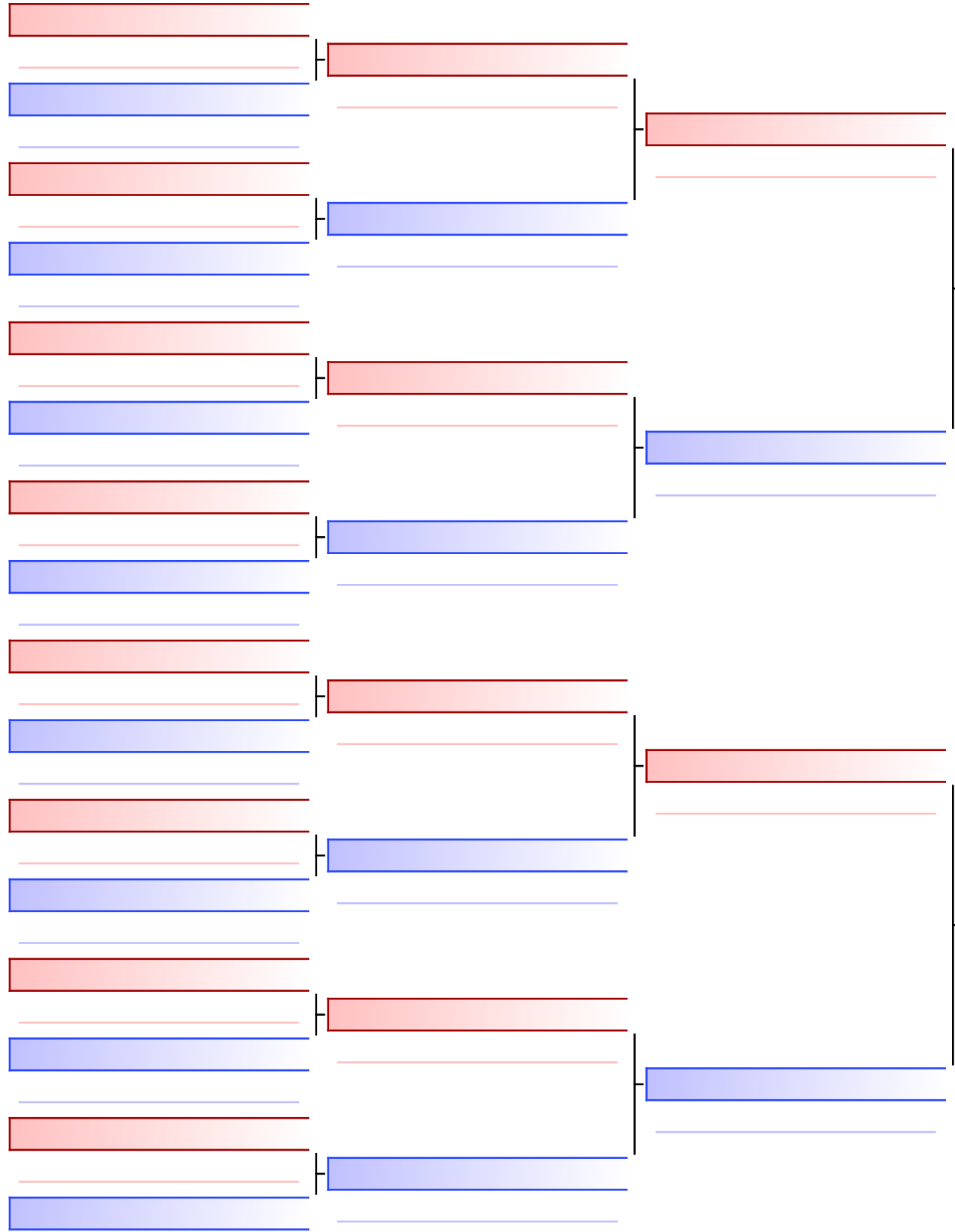

Final

PLUNKETT MICHAEL (BURNABY KARATE ACADEMY, CAN)

2

PLUNKETT MICHAEL (BURNABY KARATE ACADEMY, CAN)

POOLE CARSON (TIGERS EYE KARATE-DO NORTH SHORE, CAN)

1

1. PLUNKETT MICHAEL (BURNABY KARATE ACADEMY, CAN)
2. POOLE CARSON (TIGERS EYE KARATE-DO NORTH SHORE, CAN)

Referees:			

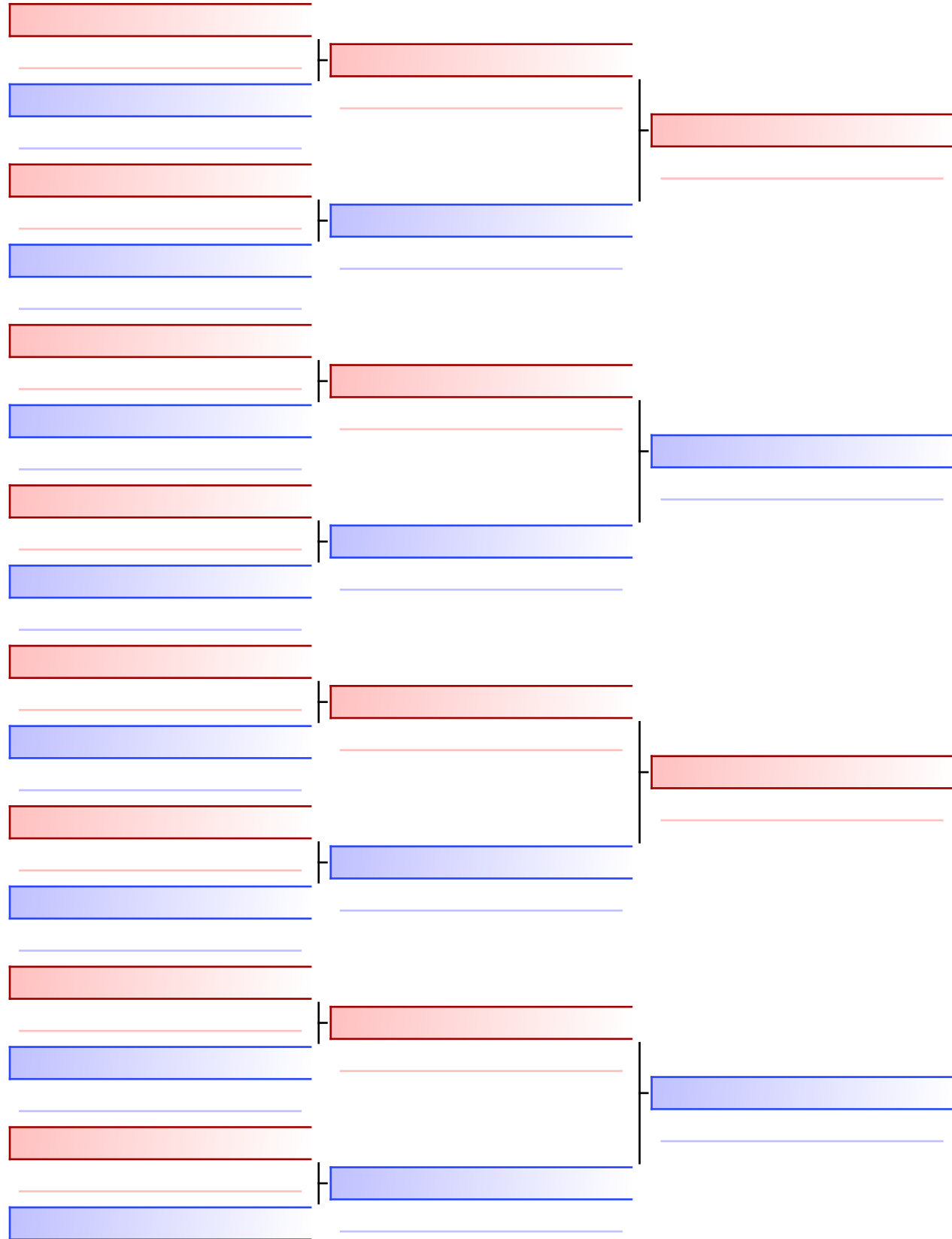

Final

TOROK LASZLO (VARSITY PERFORMANCE KARATE CLUB,CAN)

1

NOURI SEPEHR (TIGERS EYE KARATE-DO NORTH SHORE)

NOURI SEPEHR (TIGERS EYE KARATE-DO NORTH SHORE,CAN)

3

1. NOURI SEPEHR (TIGERS EYE KARATE-DO NORTH SHORE)
2. TOROK LASZLO (VARSITY PERFORMANCE KARATE CLUB)

Referees:			

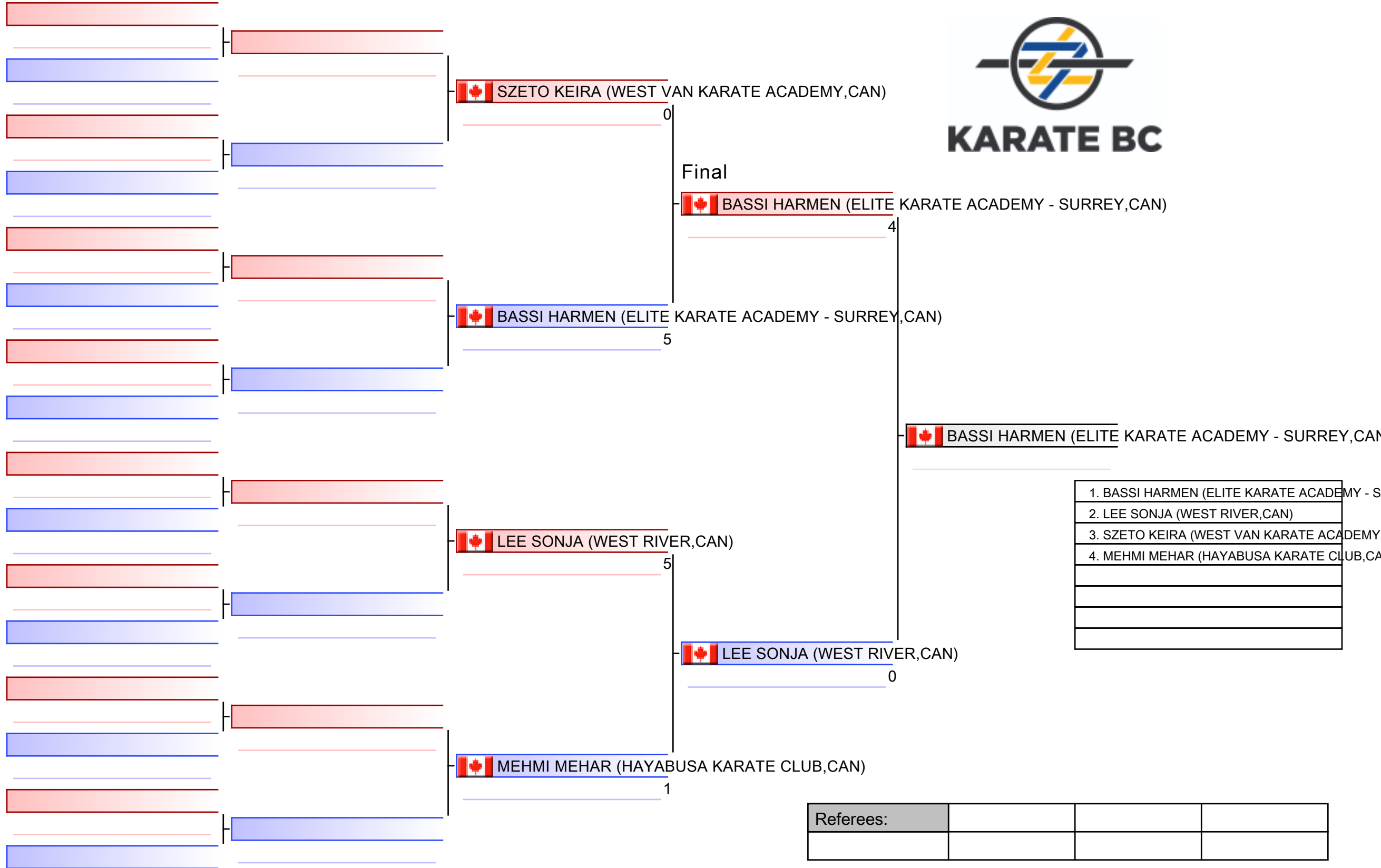

ES-5 Female Cadet (14/15) Kumite -47kg

2019 Karate BC Provincial Championships

Tatami
3 13:50

Pool
1

(c)sportdata GmbH & Co KG 2000-2019(2019-12-04 00:08) -WKF Approved- v 9.8.6 build 2 License: Karate BC (expire 2020-10-12)

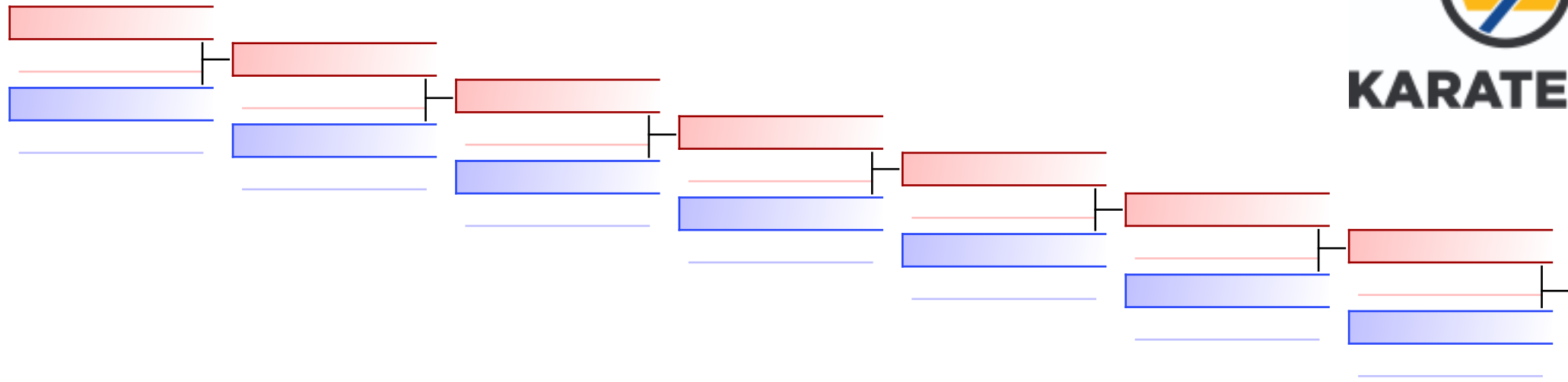

REPECHAGE: (1)

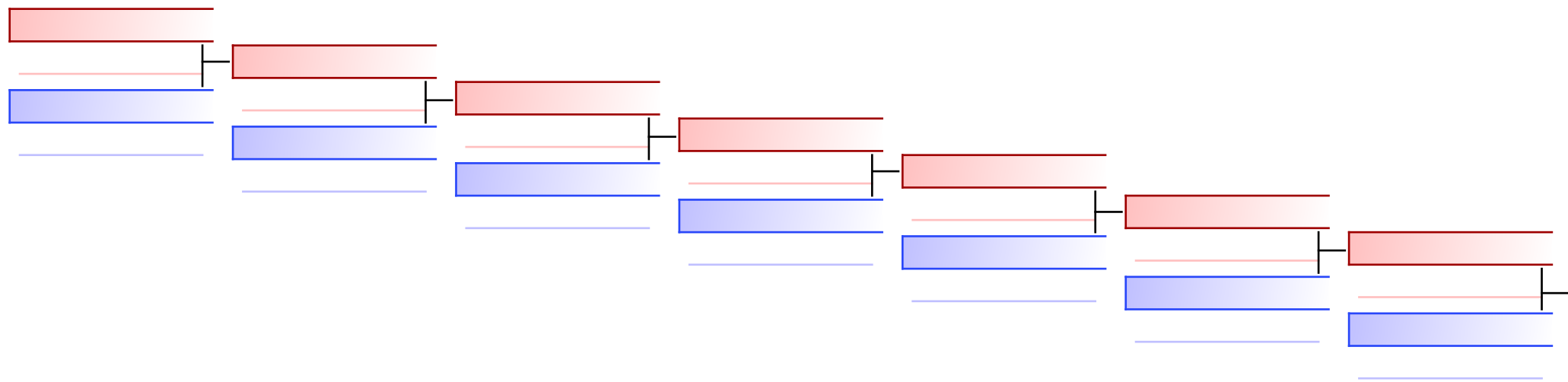

 SZETO KEIRA (WEST VAN KARA)
1

 SZETO KEIRA (WEST VAN KARA)

 MEHMI MEHAR (HAYABUSA KAR)
0

Referees:							
-----------	--	--	--	--	--	--	--

ES-6 Female Cadet (14/15) Kumite -54kg

2019 Karate BC Provincial Championships, CAN

Tatami
2 13:15

Pool
1/1

CAN MATHARU PRABHVIR (ELITE KARATE ACADEMY - SURREY,CAN) 0
CAN WAHJONO GRACE (BURNABY KARATE ACADEMY,CAN) 0

CAN WAHJONO GRACE (BURNABY KARATE ACADEMY,CAN) 6
CAN GAMBOA OONAH (KINGSWAY SHITO-RYU,CAN) 8

CAN GAMBOA OONAH (KINGSWAY SHITO-RYU,CAN) 3
CAN BRODIE OLIVIA (VARSITY PERFORMANCE KARATE CLUB,CAN) 4

CAN BRODIE OLIVIA (VARSITY PERFORMANCE KARATE CLUB,CAN) 4
CAN BRODIE OLIVIA (VARSITY PERFORMANCE KARATE CLUB,CAN) 3

CAN LIANG MEGAN (WEST RIVER,CAN) 2
CAN BRODIE OLIVIA (VARSITY PERFORMANCE KARATE CLUB,CAN) 8

CAN PORTER SYDNEY (HAYABUSA KARATE CLUB,CAN) 1
CAN BRODIE OLIVIA (VARSITY PERFORMANCE KARATE CLUB,CAN) 7

CAN VILLAMENTE NINA (WEST RIVER,CAN) 3
CAN GURAM SIMRIT (BURNABY KARATE ACADEMY,CAN) 3

CAN GURAM SIMRIT (BURNABY KARATE ACADEMY,CAN) 8
CAN ANDRES HELENA (HOLLYBURN KARATE CLUB,CAN) 2

CAN ANDRES HELENA (HOLLYBURN KARATE CLUB,CAN) 8
CAN REID LAUREN (RODNEY HOBSON KARATE ACADEMY,CAN) 3

CAN ZOHOURIAN ELENA (TIGERS EYE KARATE-DO NORTH SHORE,CAN) 1
CAN REID LAUREN (RODNEY HOBSON KARATE ACADEMY,CAN) 6

CAN REID LAUREN (RODNEY HOBSON KARATE ACADEMY,CAN) 6
CAN REID LAUREN (RODNEY HOBSON KARATE ACADEMY,CAN) 7

CAN COLINARES BREANNA (BURNABY KARATE ACADEMY,CAN) 0



Final

CAN BRODIE OLIVIA (VARSITY PERFORMANCE KARATE CLUB,CAN) 7

CAN BRODIE OLIVIA (VARSITY PERFORMANCE KARATE CLUB,CAN)

- | |
|---|
| 1. BRODIE OLIVIA (VARSITY PERFORMANCE KARATE CLUB,CAN) |
| 2. REID LAUREN (RODNEY HOBSON KARATE ACADEMY,CAN) |
| 3. PORTER SYDNEY (HAYABUSA KARATE CLUB,CAN) |
| 4. ANDRES HELENA (HOLLYBURN KARATE CLUB,CAN) |
| 5. GAMBOA OONAH (KINGSWAY SHITO-RYU,CAN) |
| 5. ZOHOURIAN ELENA (TIGERS EYE KARATE-DO NORTH SHORE,CAN) |
| 7. LIANG MEGAN (WEST RIVER,CAN) |
| 7. COLINARES BREANNA (BURNABY KARATE ACADEMY,CAN) |

CAN REID LAUREN (RODNEY HOBSON KARATE ACADEMY,CAN) 3

Referees:			

ES-6 Female Cadet (14/15) Kumite -54kg

2019 Karate BC Provincial Championships

(c)sportdata GmbH & Co KG 2000-2019(2019-12-04 00:08) -WKF Approved- v 9.8.6 build 2 License: Karate BC (expire 2020-10-12)

Tatami
2 14:10

Pool
1

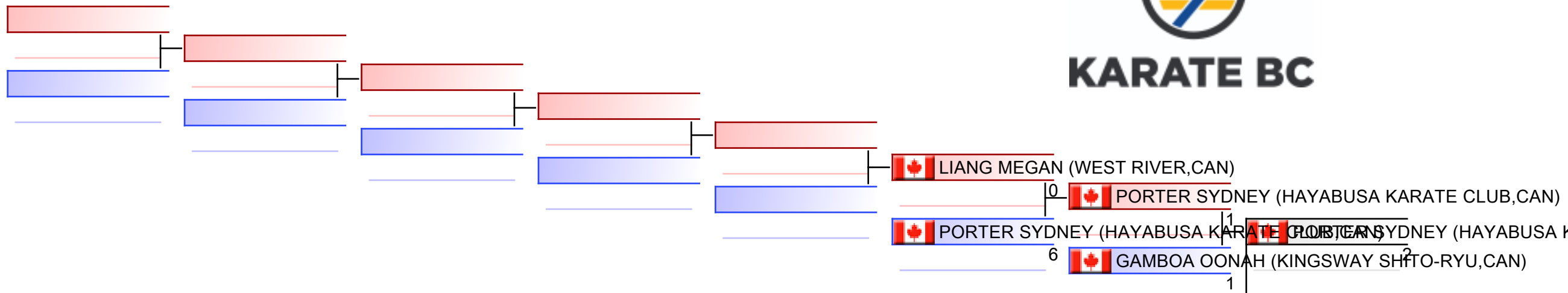

REPECHAGE: (1)

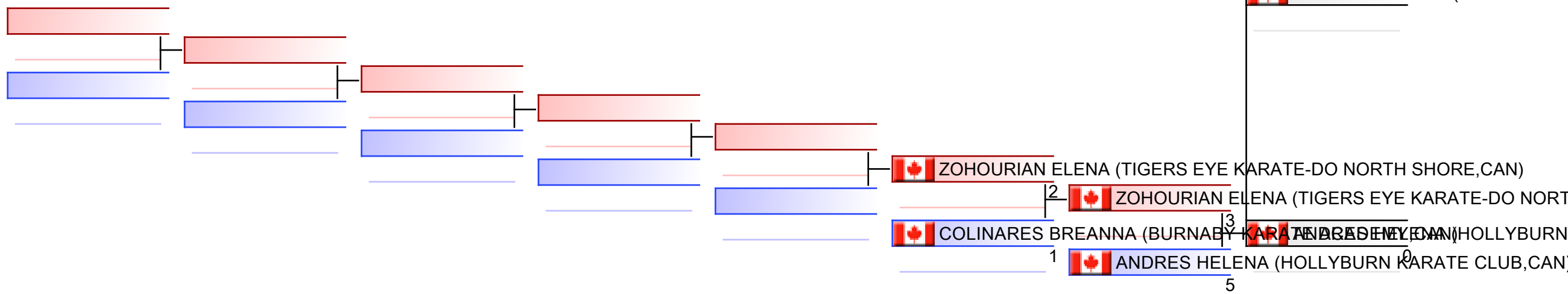

Referees:							
-----------	--	--	--	--	--	--	--

ES-7 Female Cadet (14/15) Kumite +54kg

2019 Karate BC Provincial Championships, CAN

Tatami
3 14:10

Pool
1/1

 BRAR HARLEEN (ELITE KARATE ACADEMY - SURREY,CAN)

3  SCOTT JENNA (NORTH WEST SHITO-KAI,CAN)

 SCOTT JENNA (NORTH WEST SHITO-KAI,CAN) 4

4  SCOTT JENNA (NORTH WEST SHITO-KAI,CAN) 1

 DAVISON FAITH (KENZEN SPORTS KARATE,CAN) 0

Final

 SCOTT JENNA (NORTH WEST SHITO-KAI,CAN)

 BALAZADEH_MINOUEI PARTO (TIGERS EYE KARATE-DO NORTH SHORE,CAN) 1

 BALAZADEH_MINOUEI PARTO (TIGERS EYE KARATE-DO NORTH SHORE,CAN) 0

 ARNOTT BROOKE (ASHCROFT KARATE CLUB,CAN) 0

 SCOTT JENNA (NORTH WEST SHITO-KAI,CAN)

 UPPAL KHUSHNEET (ELITE KARATE ACADEMY - SURREY,CAN) 2

 UPPAL KHUSHNEET (ELITE KARATE ACADEMY - SURREY,CAN) 0

 CROWLE ELLA (VARSITY PERFORMANCE KARATE CLUB,CAN) 0

 UPPAL KHUSHNEET (ELITE KARATE ACADEMY - SURREY,CAN)

 LUM STEPHANIE (WEST VAN KARATE ACADEMY,CAN) 4

 GILL RIYA (ELITE KARATE ACADEMY - SURREY,CAN) 0

 GILL RIYA (ELITE KARATE ACADEMY - SURREY,CAN) 6



- | |
|---|
| 1. SCOTT JENNA (NORTH WEST SHITO-KAI,CAN) |
| 2. UPPAL KHUSHNEET (ELITE KARATE ACADEMY - SURREY,CAN) |
| 3. DAVISON FAITH (KENZEN SPORTS KARATE,CAN) |
| 4. CROWLE ELLA (VARSITY PERFORMANCE KARATE CLUB,CAN) |
| 5. GILL RIYA (ELITE KARATE ACADEMY - SURREY,CAN) |
| 5. BALAZADEH_MINOUEI PARTO (TIGERS EYE KARATE-DO NORTH SHORE,CAN) |
| 7. BRAR HARLEEN (ELITE KARATE ACADEMY - SURREY,CAN) |

Referees:			

ES-7 Female Cadet (14/15) Kumite +54kg

2019 Karate BC Provincial Championships

(c)sportdata GmbH & Co KG 2000-2019(2019-12-04 00:08) -WKF Approved- v 9.8.6 build 2 License: Karate BC (expire 2020-10-12)

Tatami
3 14:50

Pool
1

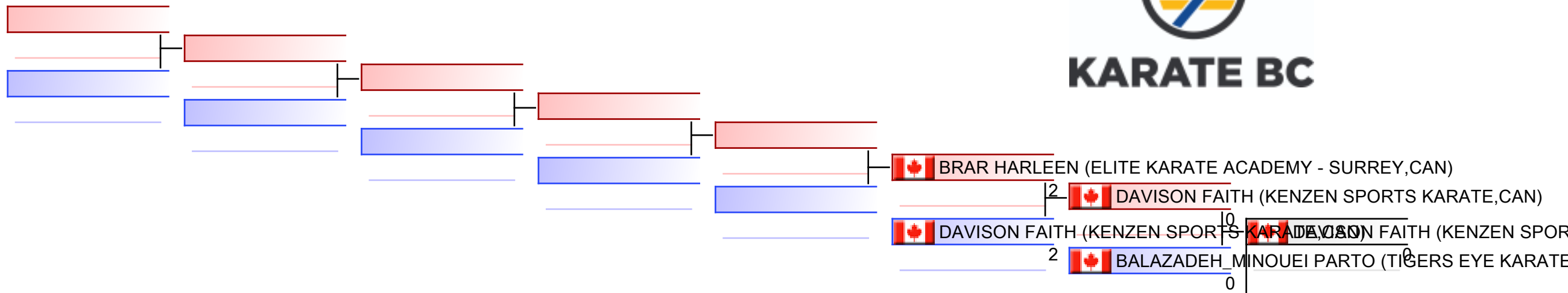

REPECHAGE: (1)

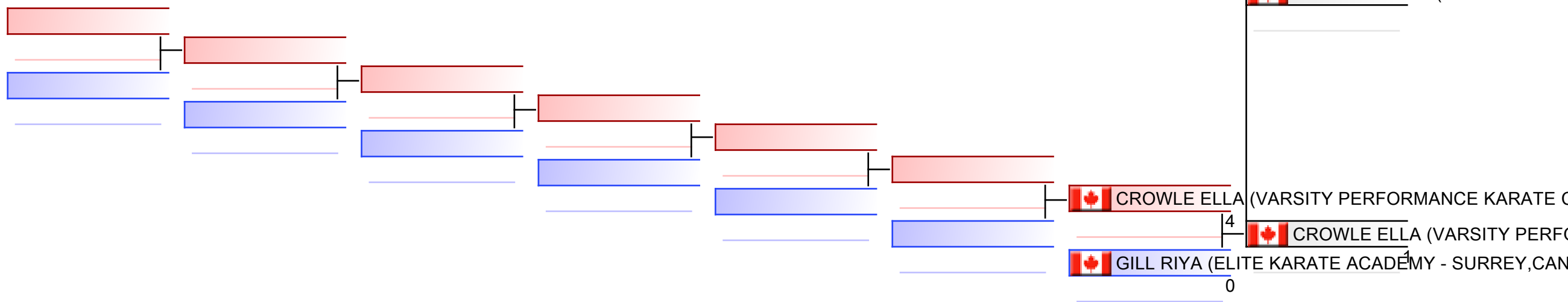

Referees:							
-----------	--	--	--	--	--	--	--

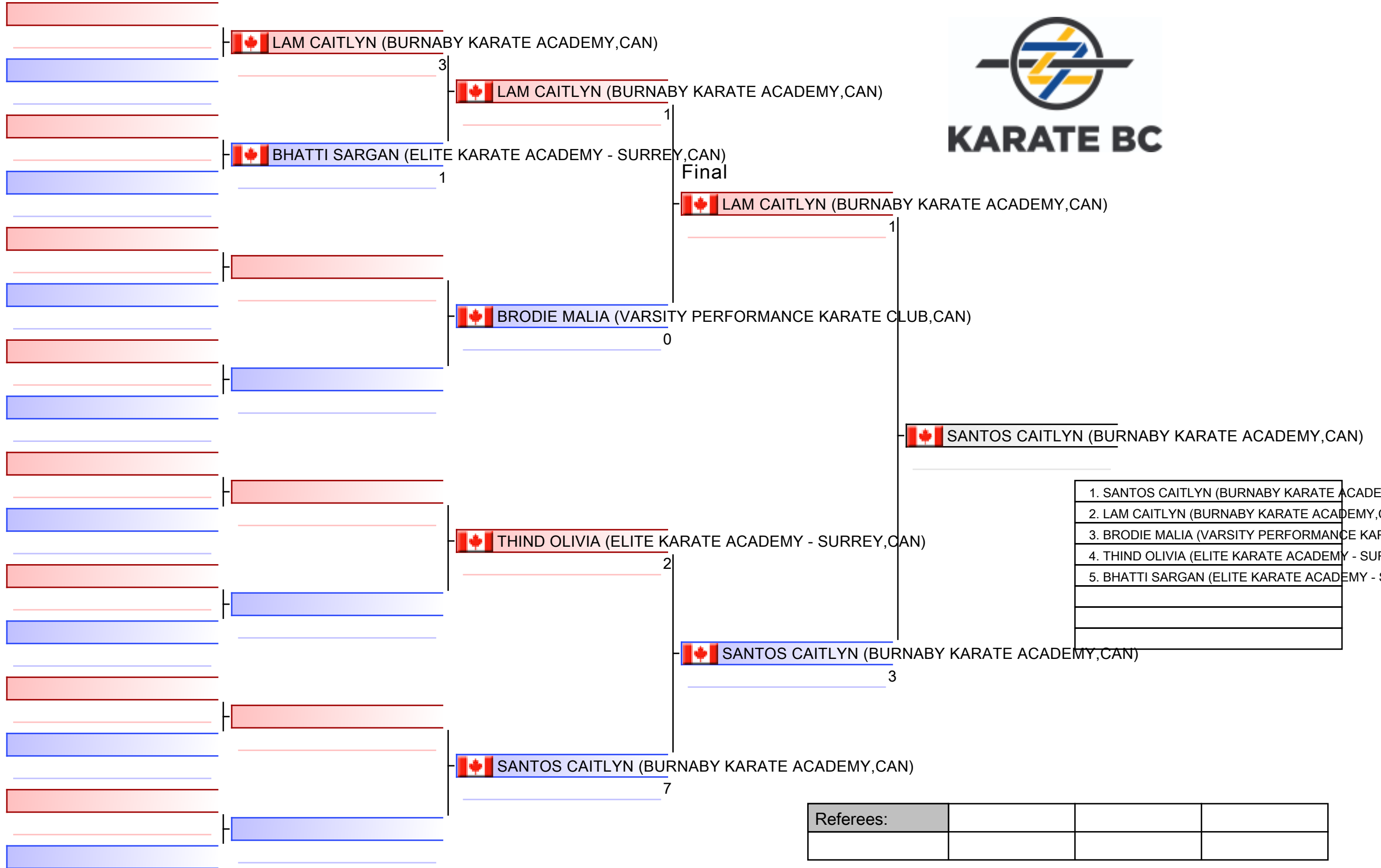

- | |
|--|
| 1. SANTOS CAITLYN (BURNABY KARATE ACADEMY, CAN) |
| 2. LAM CAITLYN (BURNABY KARATE ACADEMY, CAN) |
| 3. BRODIE MALIA (VARSITY PERFORMANCE KARATE CLUB, CAN) |
| 4. THIND OLIVIA (ELITE KARATE ACADEMY - SURREY, CAN) |
| 5. BHATTI SARGAN (ELITE KARATE ACADEMY - SURREY, CAN) |
| |
| |
| |

Referees:			

ES-8 Female Junior (16/17) Kumite -48kg

2019 Karate BC Provincial Championships

(c)sportdata GmbH & Co KG 2000-2019(2019-12-04 00:08) -WKF Approved- v 9.8.6 build 2 License: Karate BC (expire 2020-10-12)

Tatami
3 11:40

Pool
1

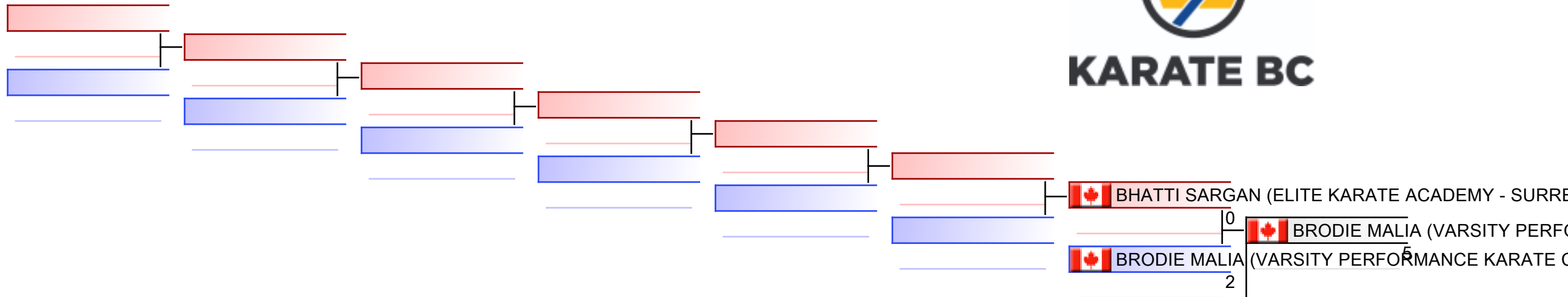

REPECHAGE: (1)

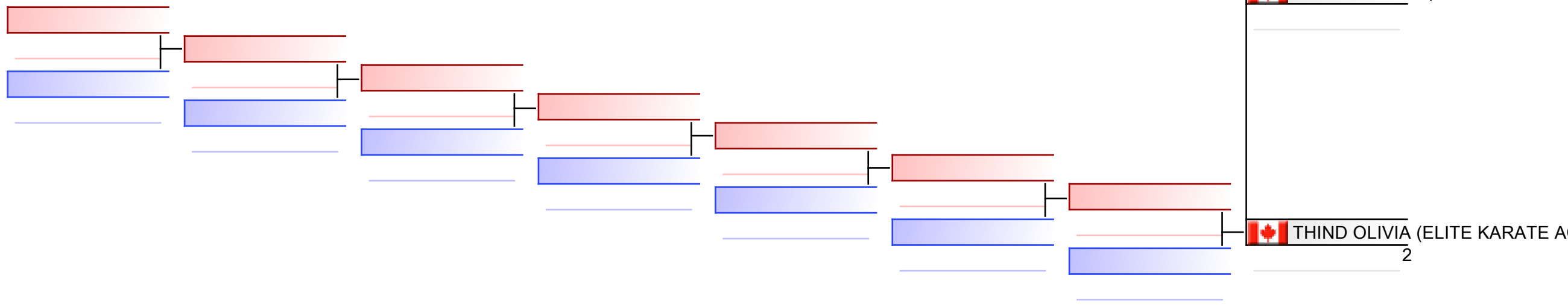

Referees:							
-----------	--	--	--	--	--	--	--



KARATE BC

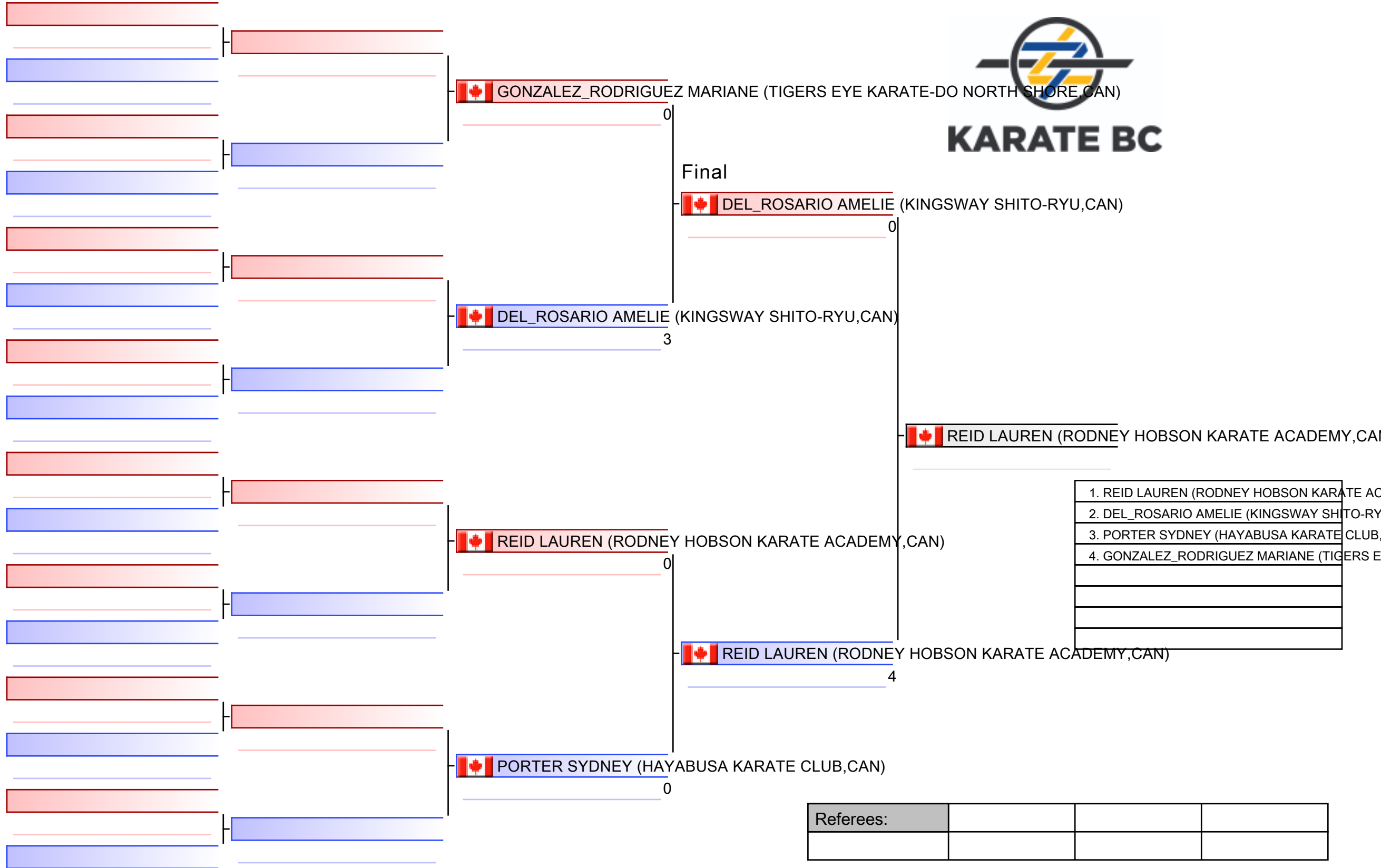

ES-9 Female Junior (16/17) Kumite -53kg

2019 Karate BC Provincial Championships

(c)sportdata GmbH & Co KG 2000-2019(2019-12-04 00:08) -WKF Approved- v 9.8.6 build 2 License: Karate BC (expire 2020-10-12)

Tatami

Pool

1

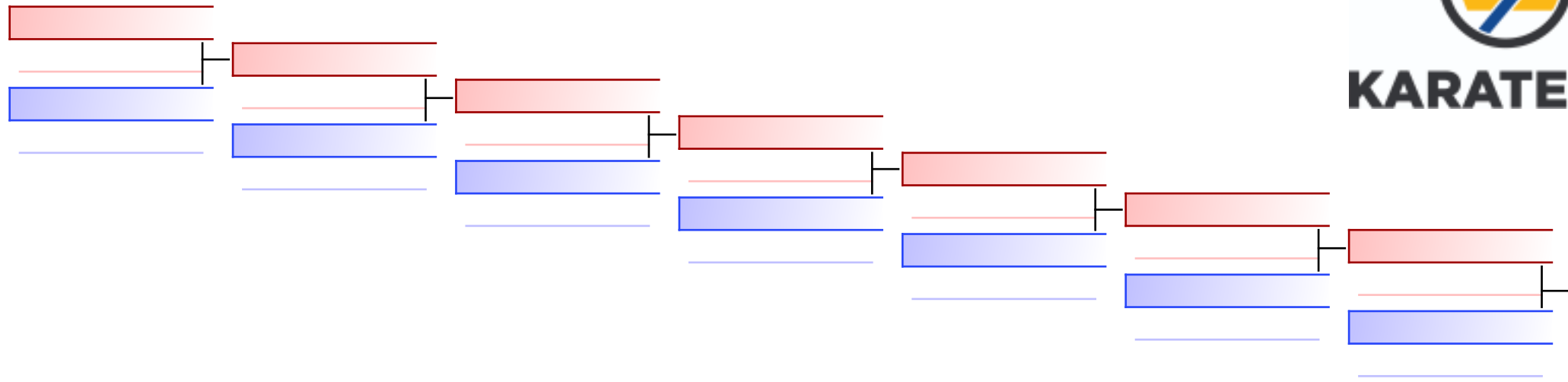

REPECHAGE: (1)

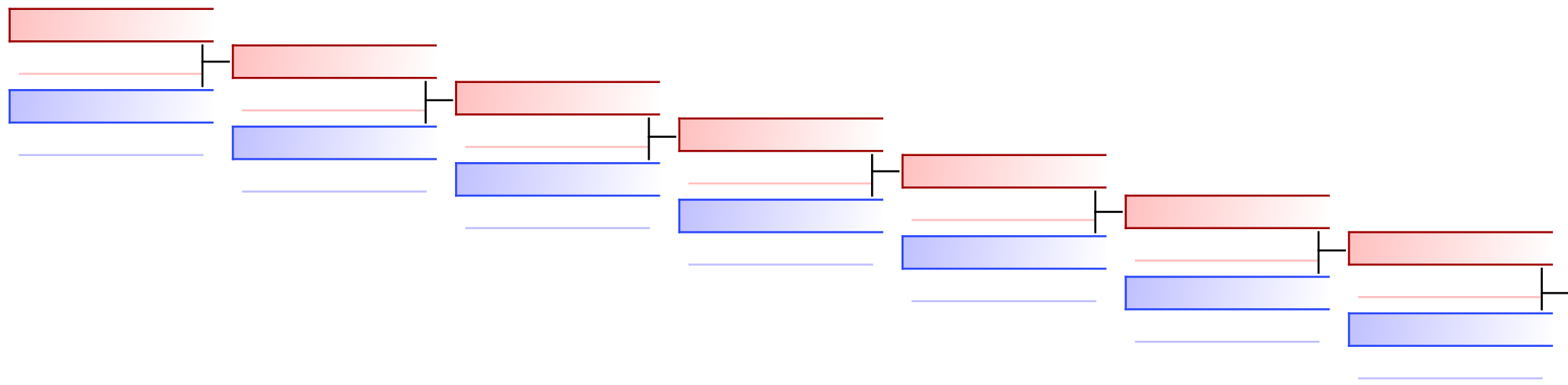

 GONZALEZ_RODRIGUEZ MARIA
2

 PORTER SYDNEY (HAYABUSA K)

 PORTER SYDNEY (HAYABUSA K)
5

Referees:							
-----------	--	--	--	--	--	--	--



2019 Karate BC Provincial Championships - 2019-11-30
 ETK-3 Senior Female Team Kata

R1 G1/1 (1)

Competitors	Kata	1 T	1 A	2 T	2 A	3 T	3 A	4 T	4 A	5 T	5 A	6 T	6 A	7 T	7 A	TEC	ATH	Extra	Total Rank	
1 KIMNIK SHOTOKAN KARATE ACADEMY (MALEKI_RIZI, NAJAFI, TEJA) (KIMNIK SHOTOKAN KARATE ACADEMY.CAN)	KANKU SHO	8.0	8.0	(7.6)	8.0	7.8	(7.6)	(8.6)	(8.6)	8.4	8.4	(5.0)	(5.0)	(10.0)	(10.0)	16.94	7.32		24.26	1

Results

1 KIMNIK SHOTOKAN KARATE ACADEMY - MALEKI RIZI SETARE - NAJAFI NIKA - TEJA ANEKAH	KIMNIK SHOTOKAN KARATE ACADEMY		CANADA
--	--------------------------------	--	--------



2019 Karate BC Provincial Championships - 2019-11-30

ETK-6 Senior Male Team Kata

R1 G1/1 (1)

Competitors		Kata	1 T	1 A	2 T	2 A	3 T	3 A	4 T	4 A	5 T	5 A	6 T	6 A	7 T	7 A	TEC	ATH	Extra	Total Rank
1	KINGSWAY SHITO-RYU (SAWAL, WASADA, YAO) (KINGSWAY SHITO-RYU,CAN)	ANAN DAI	8.2	8.2	(6.9)	(6.9)	(8.4)	(8.6)	8.0	8.0	7.8	8.4					16.8	7.38		24.181

Results

1	KINGSWAY SHITO-RYU - YAO EDWARD - SAWAL JOHN - WASADA SOTARO	KINGSWAY SHITO-RYU		CANADA
---	---	--------------------	---	--------

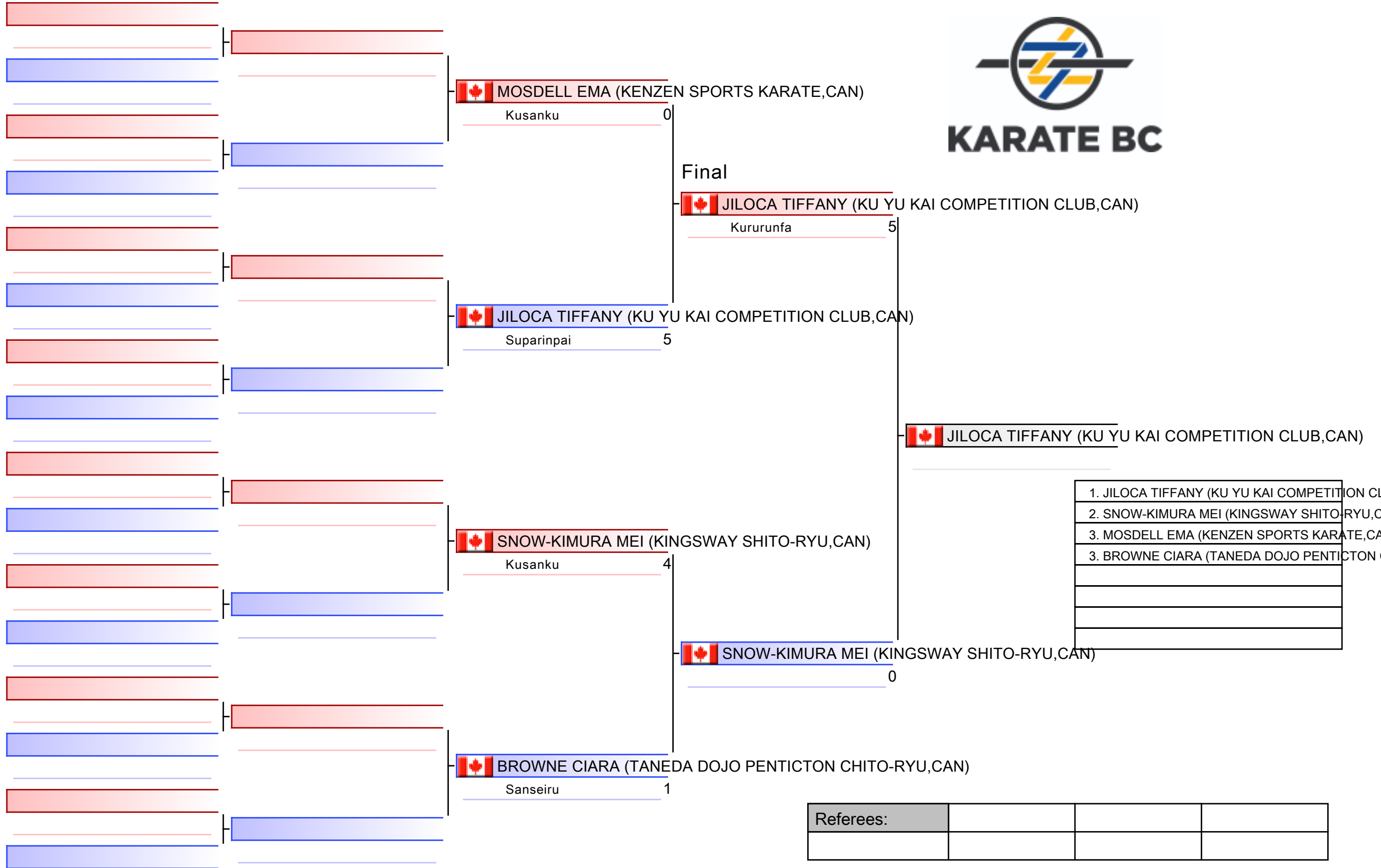

RK-10 Girls 12/13 - Kata Adv/Black

2019 Karate BC Provincial Championships

Tatami

Pool

1

(c)sportdata GmbH & Co KG 2000-2019(2019-12-04 00:09) -WKF Approved- v 9.8.6 build 2 License: Karate BC (expire 2020-10-12)

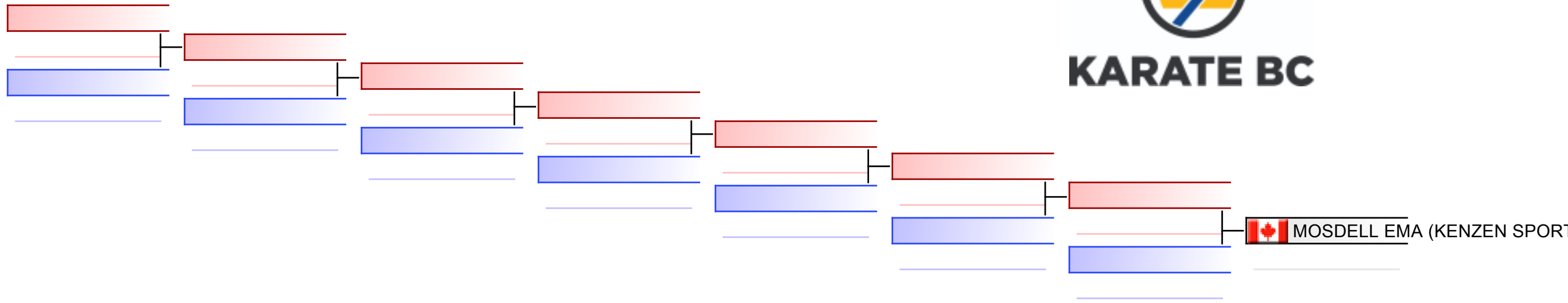

REPECHAGE: (1)

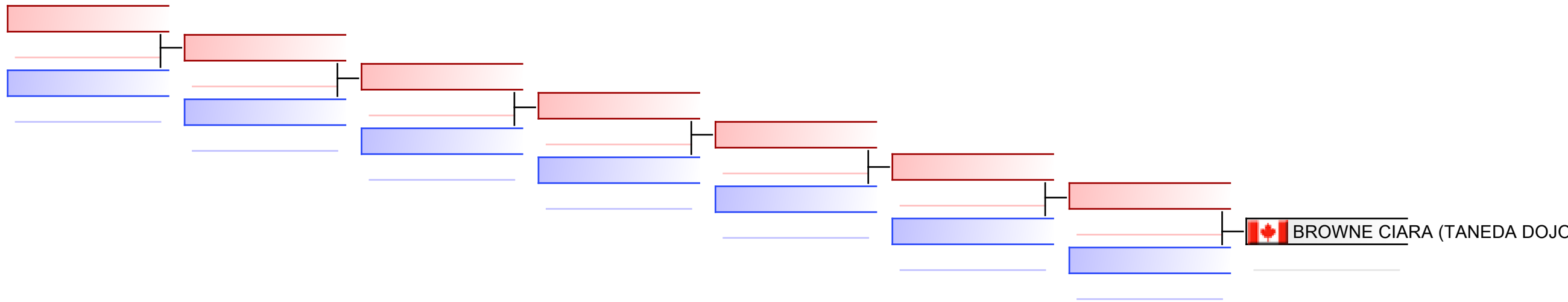

Referees:							
-----------	--	--	--	--	--	--	--

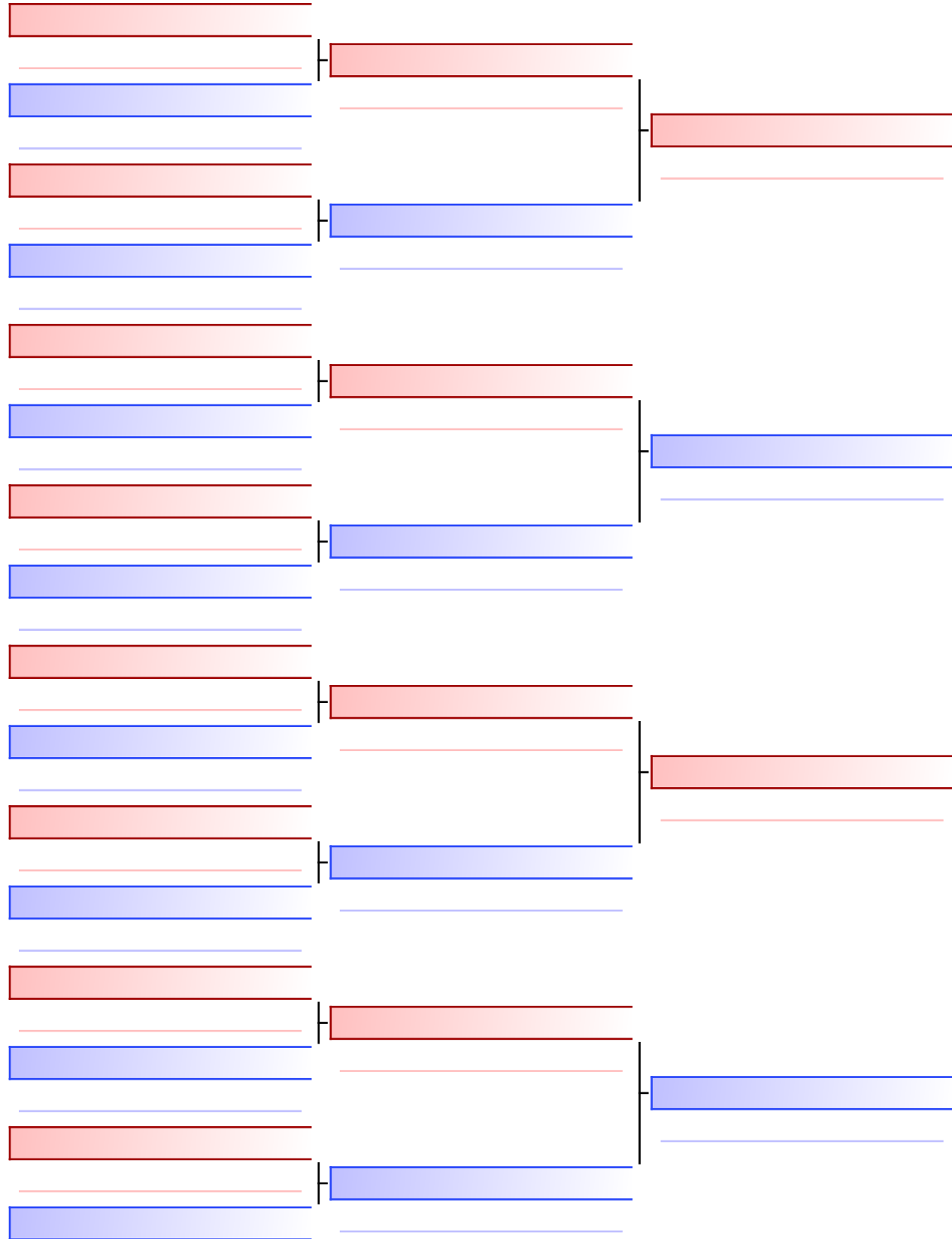

Final

 LEGGOTT LILY (TANEDA DOJO KELOWNA CHITO-RYU,CAN)

0

 LAU ELISABETH (WEST RIVER,CAN)

 LAU ELISABETH (WEST RIVER,CAN)

5

- | |
|--|
| 1. LAU ELISABETH (WEST RIVER,CAN) |
| 2. LEGGOTT LILY (TANEDA DOJO KELOWNA CHI |
| |
| |
| |
| |
| |

Referees:			



KARATE BC

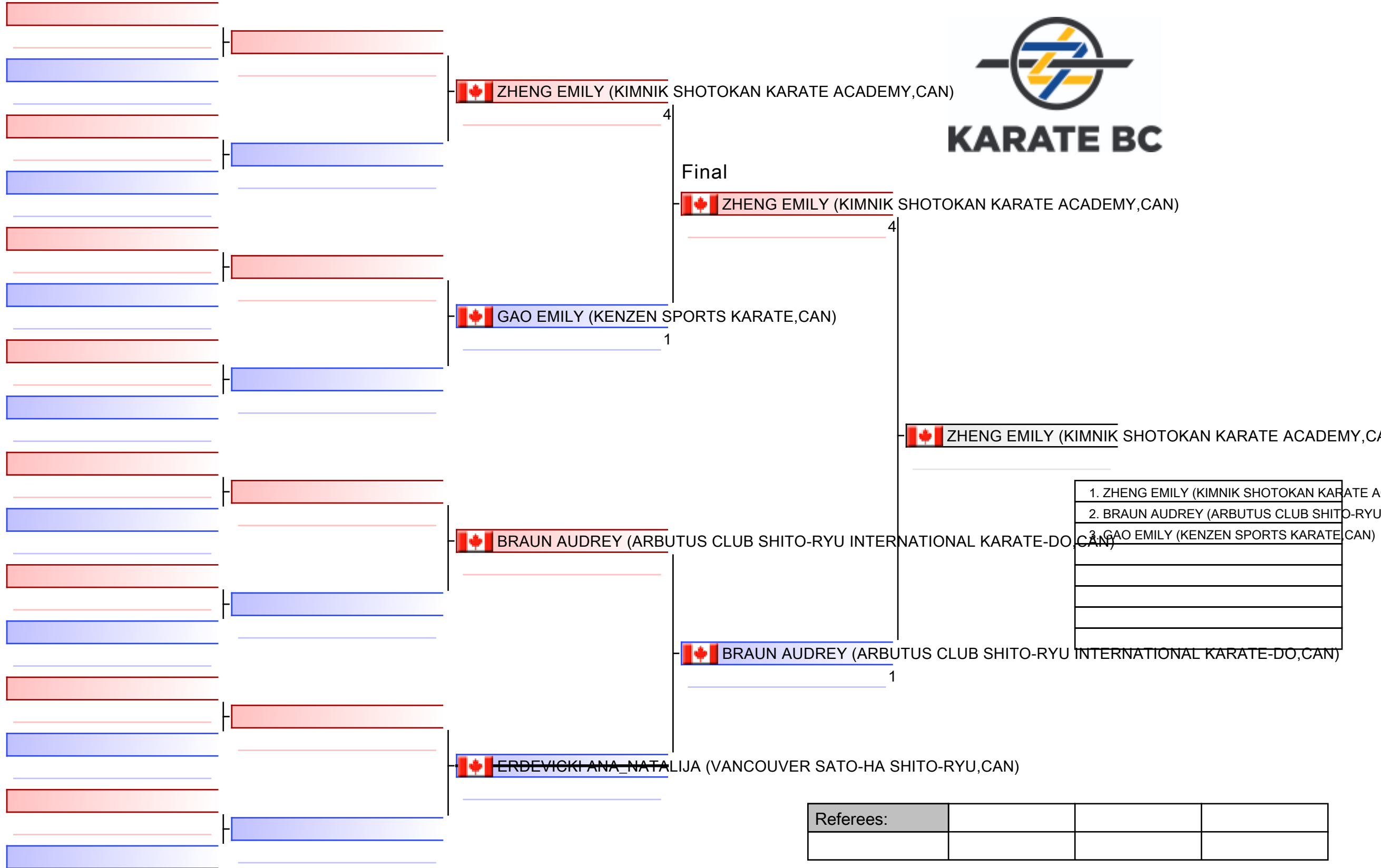

RK-13 Girls 14/15 - Kata Adv/Black

2019 Karate BC Provincial Championships

Tatami

Pool
1

(c)sportdata GmbH & Co KG 2000-2019(2019-12-04 00:09) -WKF Approved- v 9.8.6 build 2 License: Karate BC (expire 2020-10-12)

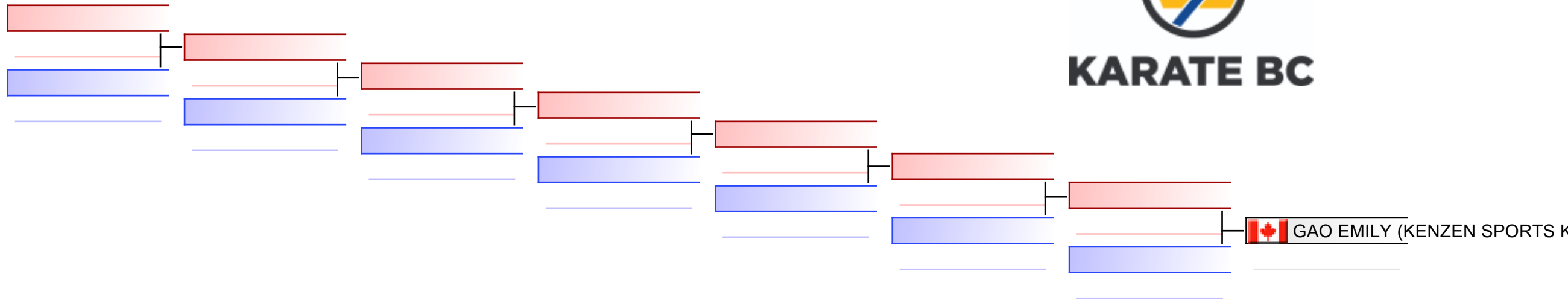

REPECHAGE: (1)

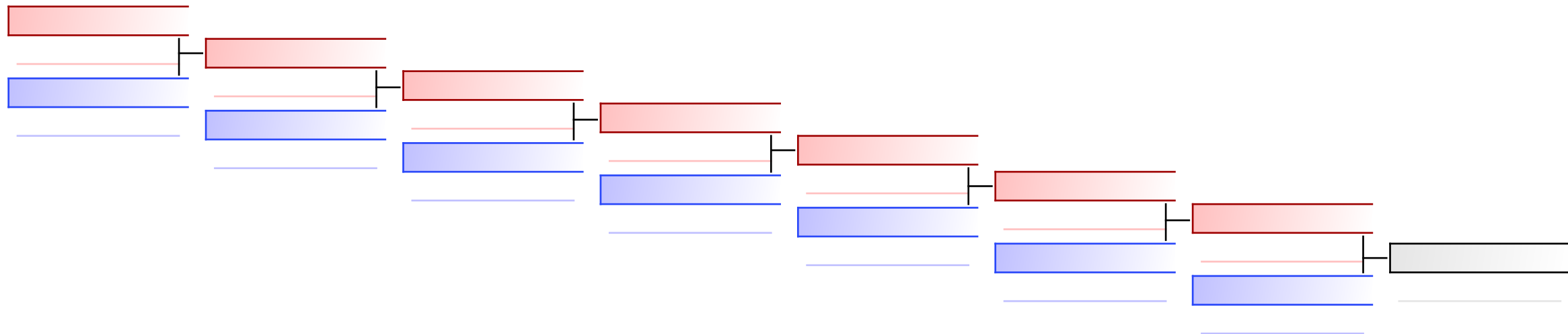

Referees:							
-----------	--	--	--	--	--	--	--

RK-1 Girls 7 & Under - Kata All belts

2019 Karate BC Provincial Championships, CAN

Tatami
1 11:20

Pool
1/1

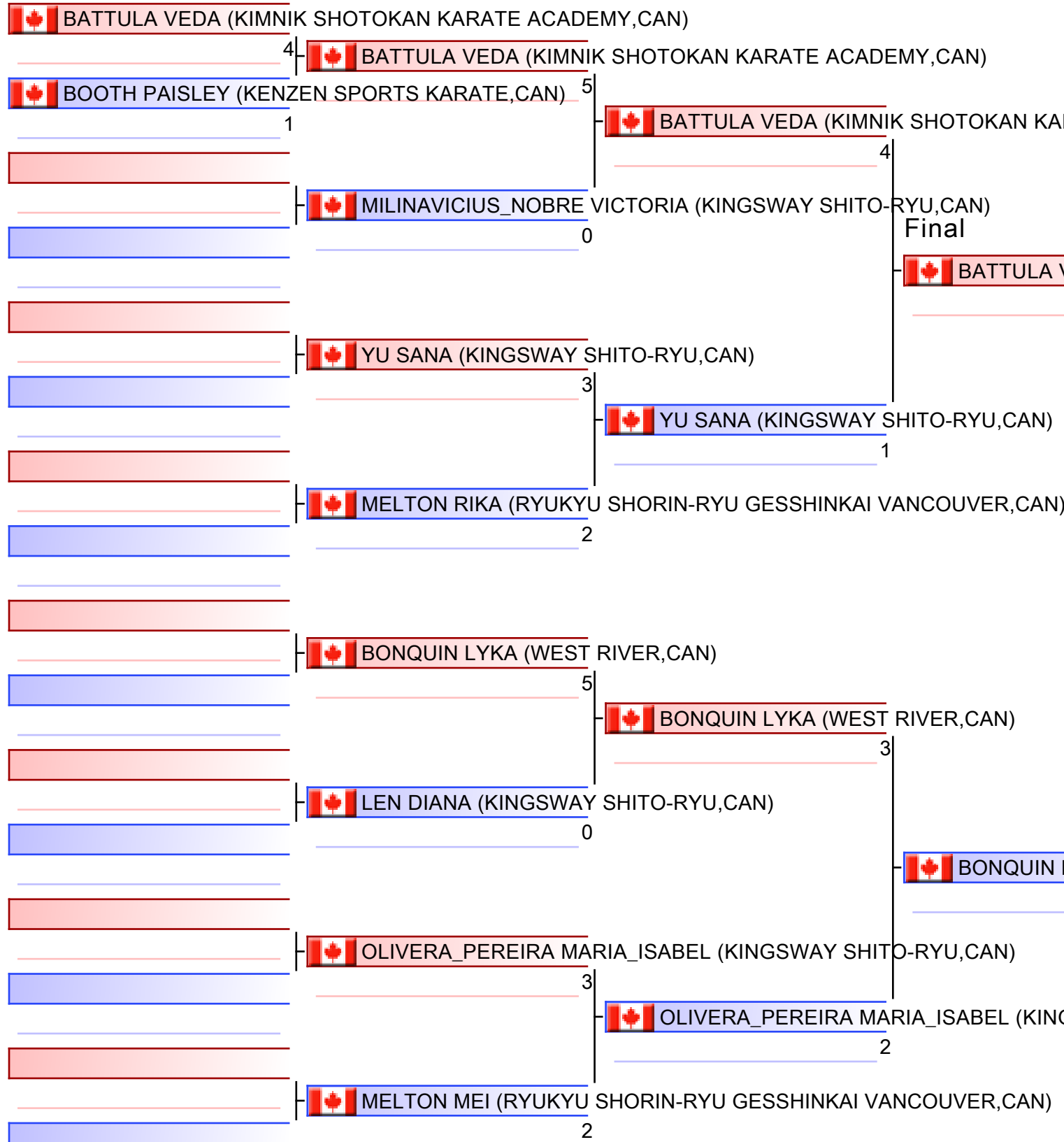

KARATE BC

Final

BATTULA VEDA (KIMNIK SHOTOKAN KARATE ACADEMY,CAN) (0)

BONQUIN LYKA (WEST RIVER,CAN)

1. BONQUIN LYKA (WEST RIVER,CAN)
2. BATTULA VEDA (KIMNIK SHOTOKAN KARATE ACADEMY,CAN)
3. OLIVERA_PEREIRA MARIA_ISABEL (KINGSWAY SHITO-RYU,CAN)
3. YU SANA (KINGSWAY SHITO-RYU,CAN)
5. LEN DIANA (KINGSWAY SHITO-RYU,CAN)
5. BOOTH PAISLEY (KENZEN SPORTS KARATE,CAN)
7. MILINAVICIUS_NOBRE VICTORIA (KINGSWAY SHITO-RYU,CAN)

Referees:			

RK-1 Girls 7 & Under - Kata All belts

2019 Karate BC Provincial Championships

Tatami
1 11:45

Pool
1

(c)sportdata GmbH & Co KG 2000-2019(2019-12-04 00:08) -WKF Approved- v 9.8.6 build 2 License: Karate BC (expire 2020-10-12)

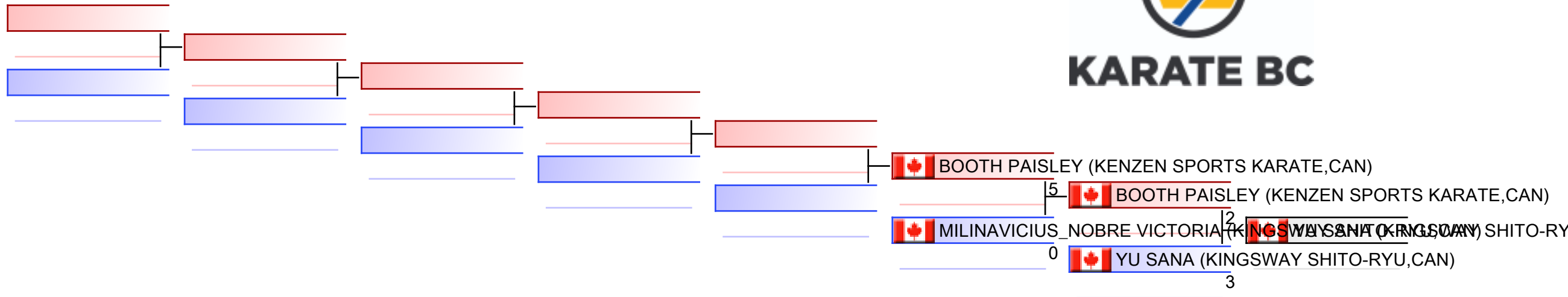

REPECHAGE: (1)

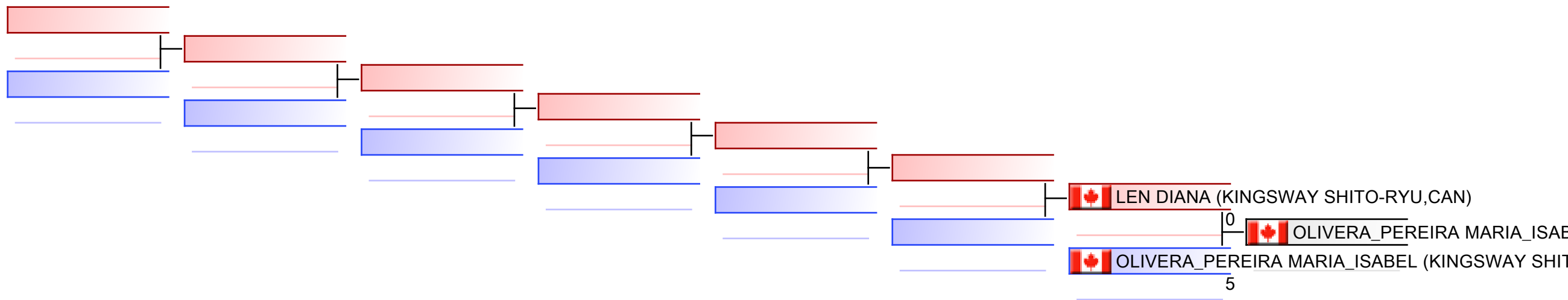













Referees:							
-----------	--	--	--	--	--	--	--

RK-20 Womens Kata Advanced - Round Robin (each against each)

2019 Karate BC Provincial Championships, CAN

Tatami
2 13:25

Pool
1/1

- 1  HADDEN HANNAH (WEST COAST GOJU-KAI,CAN)
 - 2  ZAIA ERICA (WEST RIVER,CAN)
- 2  ZAIA ERICA (WEST RIVER,CAN)
 - 3  HADDEN HANNAH (WEST COAST GOJU-KAI,CAN)
- 3  HADDEN HANNAH (WEST COAST GOJU-KAI,CAN)
 - 0  YUEN KAR-LAI (KUMAKAI KARATE VANCOUVER,CAN)
- 4  YUEN KAR-LAI (KUMAKAI KARATE VANCOUVER,CAN)
 - 5  ZAIA ERICA (WEST RIVER,CAN)
- 5  ZAIA ERICA (WEST RIVER,CAN)
 - 0  YUEN KAR-LAI (KUMAKAI KARATE VANCOUVER,CAN)
- 6  YUEN KAR-LAI (KUMAKAI KARATE VANCOUVER,CAN)
 - 5  YUEN KAR-LAI (KUMAKAI KARATE VANCOUVER,CAN)



1.	YUEN KAR-LAI (KUMAKAI KARATE VANCOUVER,CAN)
2.	ZAIA ERICA (WEST RIVER,CAN)
3.	HADDEN HANNAH (WEST COAST GOJU-KAI,CAN)

Referees:			

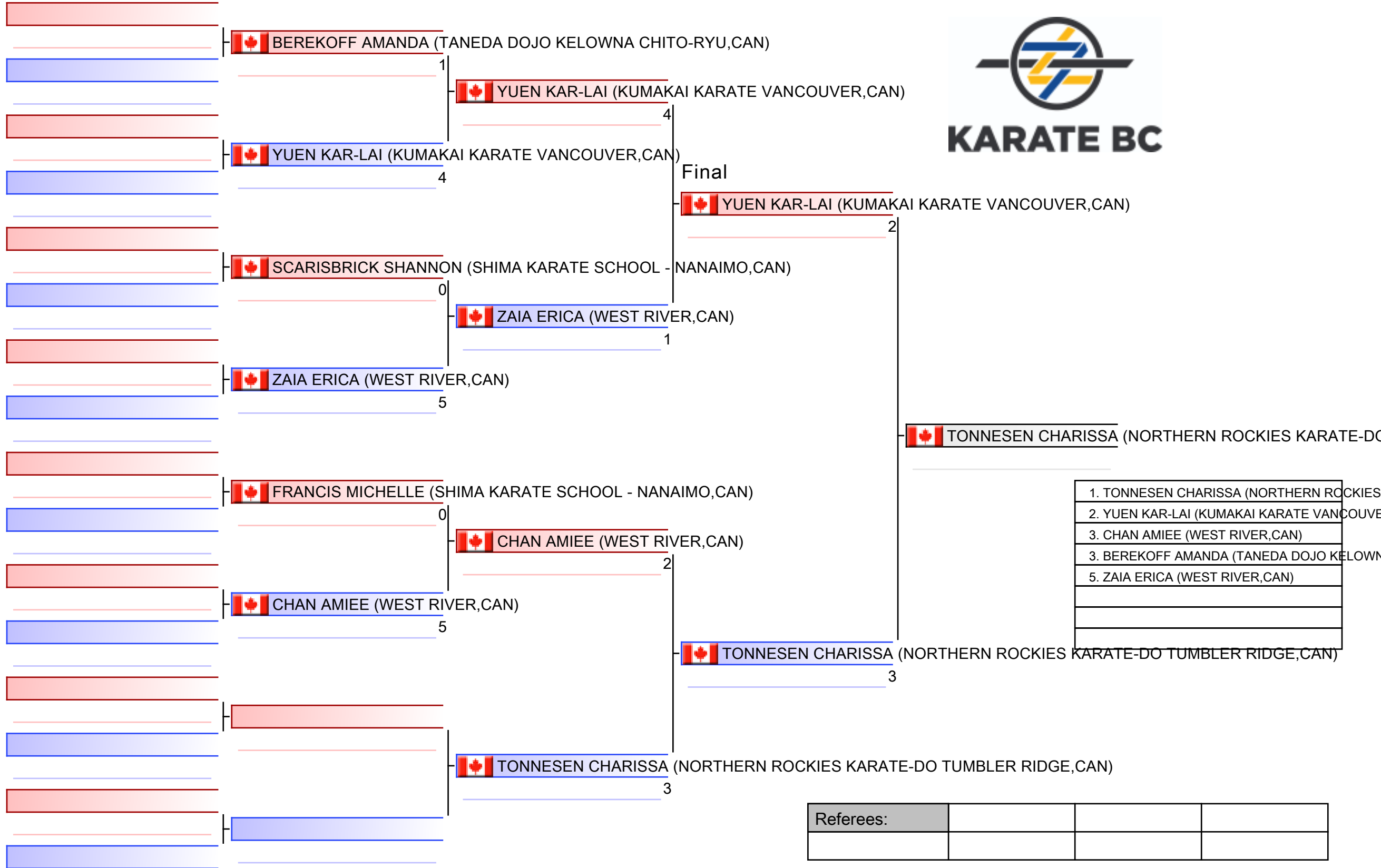

Referees:			

RK-22 Masters Womens Kata Nov to Adv

2019 Karate BC Provincial Championships

Tatami
2 12:55

Pool
1

(c)sportdata GmbH & Co KG 2000-2019(2019-12-04 00:09) -WKF Approved- v 9.8.6 build 2 License: Karate BC (expire 2020-10-12)

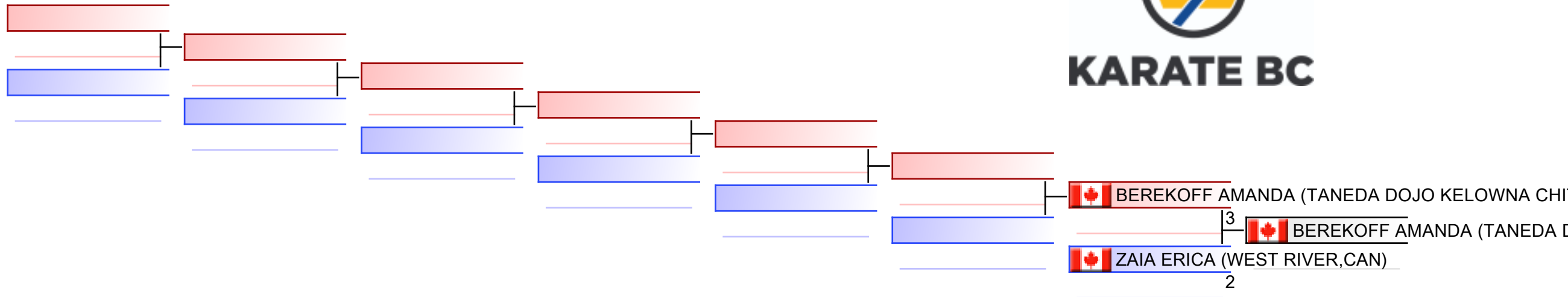

REPECHAGE: (1)

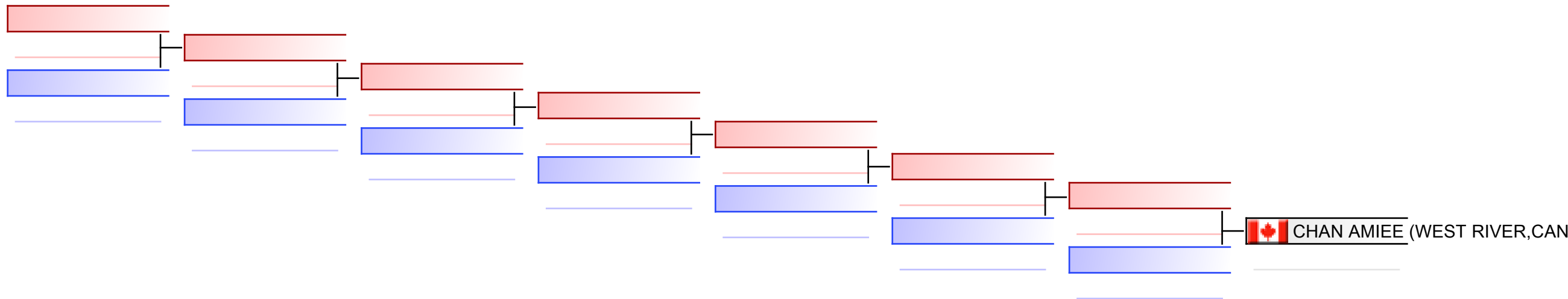

Referees:							
-----------	--	--	--	--	--	--	--

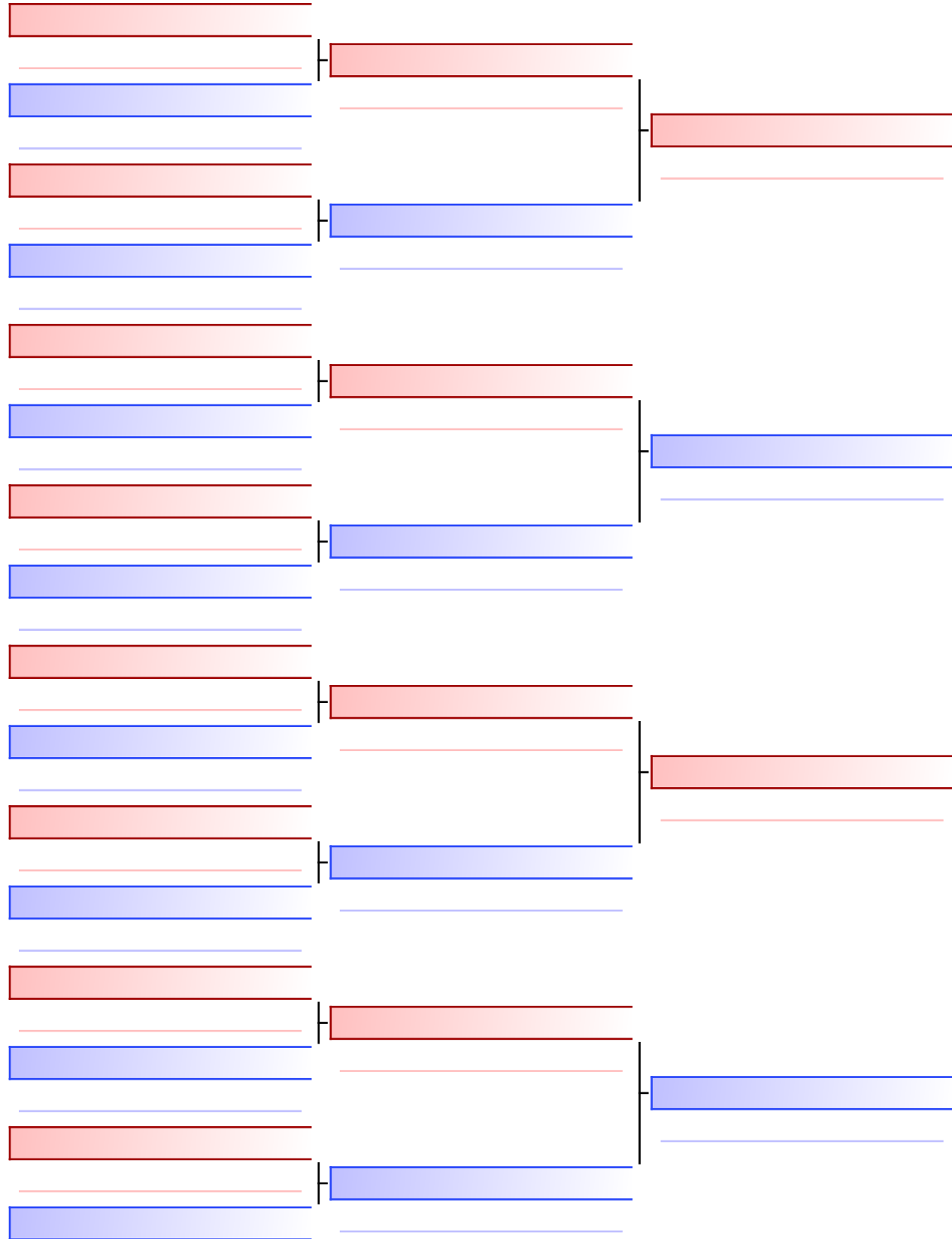

Final

TREIVISH VICTORIA (KIMNIK SHOTOKAN KARATE ACADEMY,CAN)

1

WASADA MAIKO (RYUKYU SHORIN-RYU GESSHINKAI VANCOUVER,CAN)

WASADA MAIKO (RYUKYU SHORIN-RYU GESSHINKAI VANCOUVER,CAN)

4

1. WASADA MAIKO (RYUKYU SHORIN-RYU GESSHINKAI VANCOUVER,CAN)
2. TREIVISH VICTORIA (KIMNIK SHOTOKAN KARATE ACADEMY,CAN)

Referees:			

RK-25 Boys 7 & Under - All Belts Kata

2019 Karate BC Provincial Championships, CAN

Tatami
2 11:10

Pool
1/1

NGUYEN ETHAN (KINGSWAY SHITO-RYU,CAN)

2 CHING TRAVIS (BRIGHT MARTIAL ARTS & FITNESS,CAN)

CHING TRAVIS (BRIGHT MARTIAL ARTS & FITNESS,CAN)

3 CHING TRAVIS (BRIGHT MARTIAL ARTS & FITNESS,CAN)

WEI HONGYU (STEVESTON KARATE CLUB,CAN)

0

CHOI EESAM (WEST COAST GOJU-KAI,CAN)

5 CHOI EESAM (WEST COAST GOJU-KAI,CAN)

CHENG COREY (BURNABY CHITO RYU YUSEIKAN,CAN)

0

CRUZ JACOB (KIMNIK SHOTOKAN KARATE ACADEMY,CAN)

5

CRUZ JACOB (KIMNIK SHOTOKAN KARATE ACADEMY,CAN)

5

MOI TYLER (SHITO-RYU INTERNATIONAL RICHMOND DOJO,CAN)

2 DE_LA_VALLEE_POUSSIN DANIEL (TIGERS EYE KARATE-DO NORTH SHORE,CAN)

DE_LA_VALLEE_POUSSIN DANIEL (TIGERS EYE KARATE-DO NORTH SHORE,CAN)

3 DE_LA_VALLEE_POUSSIN DANIEL (TIGERS EYE KARATE-DO NORTH SHORE,CAN)

FONG RYDER (KINGSWAY SHITO-RYU,CAN)

0

MA KYLE (BRIGHT MARTIAL ARTS & FITNESS,CAN)

2

HENDERSON CLIFFORD_JAMES (NORTHERN ROCKIES KARATE-DO PRINCE GEORGE,CAN)

0

MA KYLE (BRIGHT MARTIAL ARTS & FITNESS,CAN)

4

MA KYLE (BRIGHT MARTIAL ARTS & FITNESS,CAN)

5



Final

CRUZ JACOB (KIMNIK SHOTOKAN KARATE ACADEMY,CAN)

3

CRUZ JACOB (KIMNIK SHOTOKAN KARATE ACADEMY,CAN)

- | |
|--|
| 1. CRUZ JACOB (KIMNIK SHOTOKAN KARATE ACADEMY,CAN) |
| 2. MA KYLE (BRIGHT MARTIAL ARTS & FITNESS,CAN) |
| 3. CHING TRAVIS (BRIGHT MARTIAL ARTS & FITNESS,CAN) |
| 3. DE_LA_VALLEE_POUSSIN DANIEL (TIGERS EYE KARATE-DO NORTH SHORE,CAN) |
| 5. CHOI EESAM (WEST COAST GOJU-KAI,CAN) |
| 5. HENDERSON CLIFFORD_JAMES (NORTHERN ROCKIES KARATE-DO PRINCE GEORGE,CAN) |
| |
| |

Referees:			

RK-25 Boys 7 & Under - All Belts Kata

2019 Karate BC Provincial Championships

Tatami
2 11:45

Pool
1

(c)sportdata GmbH & Co KG 2000-2019(2019-12-04 00:09) -WKF Approved- v 9.8.6 build 2 License: Karate BC (expire 2020-10-12)

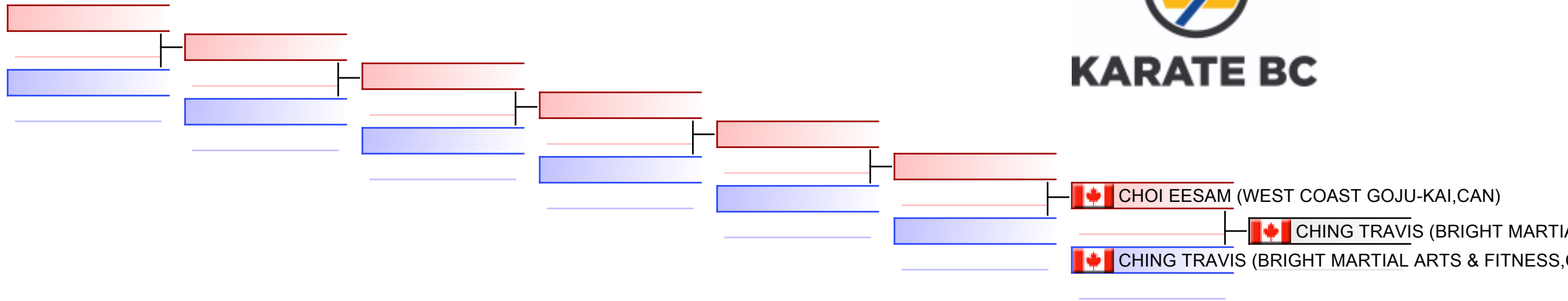

REPECHAGE: (1)

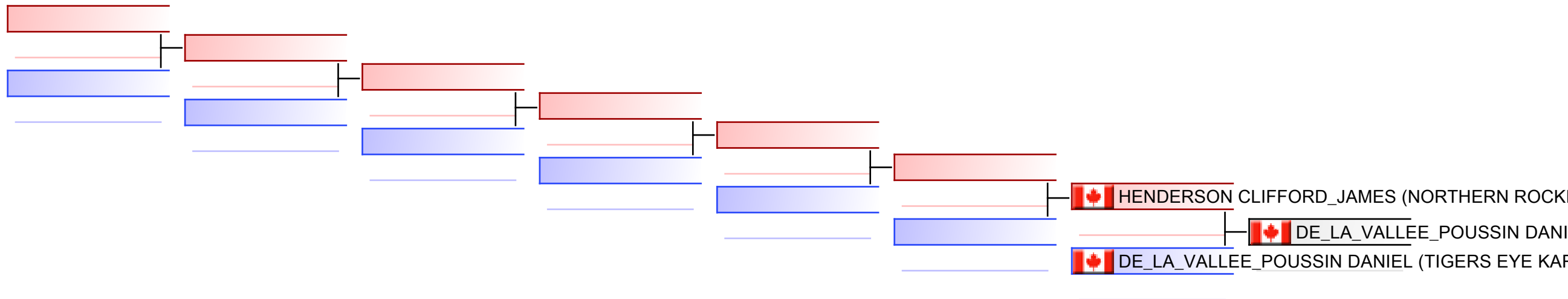

Referees:							
-----------	--	--	--	--	--	--	--

RK-26 Boys 8/9 - Kata Novice

2019 Karate BC Provincial Championships, CAN

Tatami
3 11:10

Pool
1/1

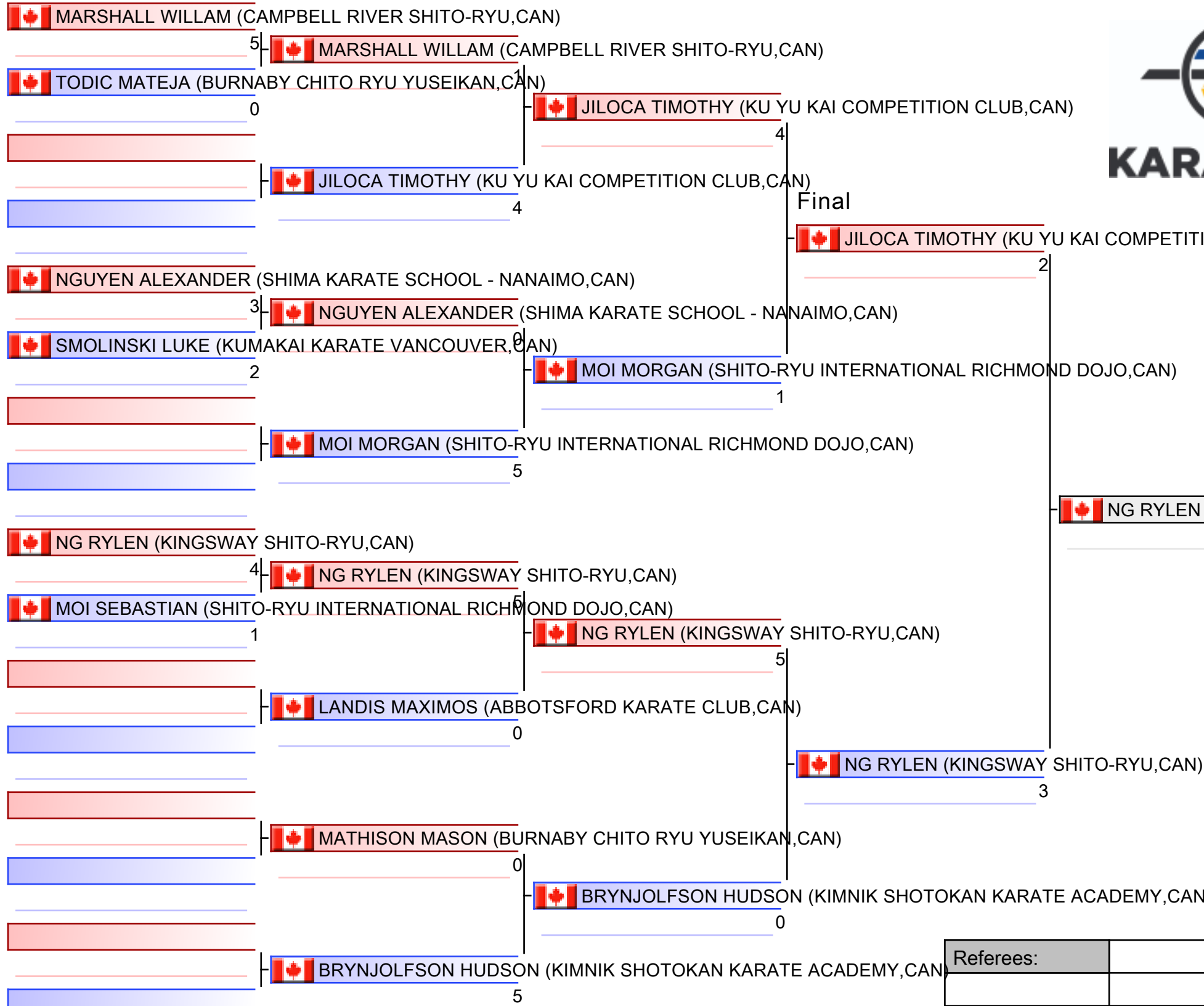

- | |
|--|
| 1. NG RYLEN (KINGSWAY SHITO-RYU,CAN) |
| 2. JILOCA TIMOTHY (KU YU KAI COMPETITION CLUB,CAN) |
| 3. MARSHALL WILLAM (CAMPBELL RIVER SHITO-RYU,CAN) |
| 3. MOI SEBASTIAN (SHITO-RYU INTERNATIONAL RICHMOND DOJO,CAN) |
| 5. MOI MORGAN (SHITO-RYU INTERNATIONAL RICHMOND DOJO,CAN) |
| 5. BRYNJOLFSON HUDSON (KIMNIK SHOTOKAN KARATE ACADEMY,CAN) |
| 7. LANDIS MAXIMOS (ABBOTSFORD KARATE CLUB,CAN) |

Referees:			

RK-26 Boys 8/9 - Kata Novice

2019 Karate BC Provincial Championships

(c)sportdata GmbH & Co KG 2000-2019(2019-12-04 00:09) -WKF Approved- v 9.8.6 build 2 License: Karate BC (expire 2020-10-12)

Tatami
3 11:45

Pool
1

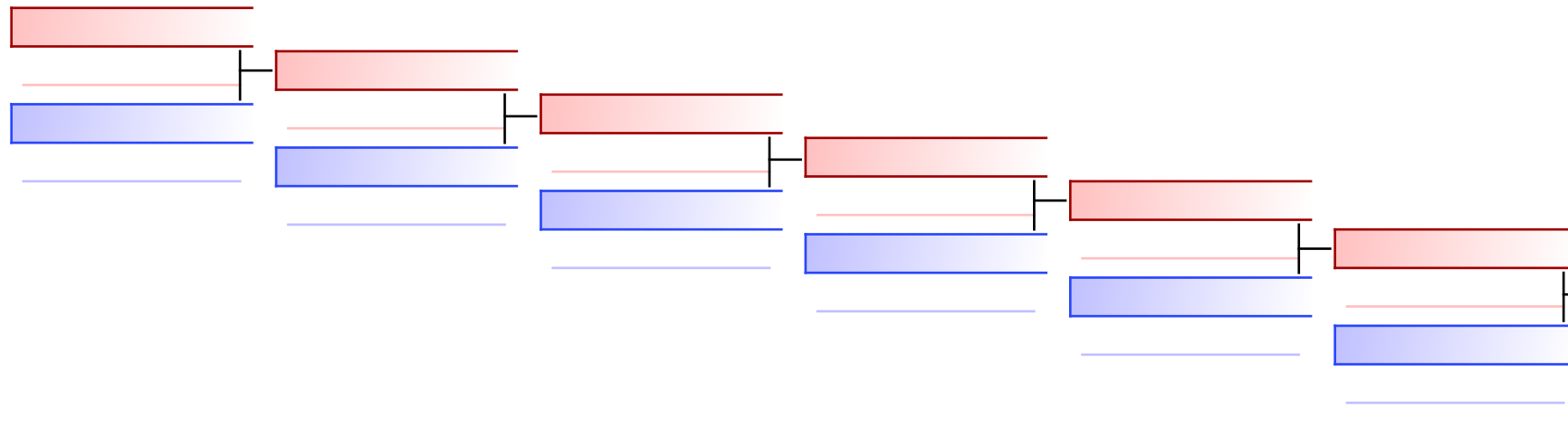

MARSHALL WILLAM (CAMPBELL RIVER SHITO-RYU, CAN) 3
 MARSHALL WILLAM (CAMPBELL RIVER SHITO-RYU, CAN) 3
 MOI MORGAN (SHITO-RYU INTERNATIONAL RICHMOND DOJO, CAN) 2

REPECHAGE: (1)

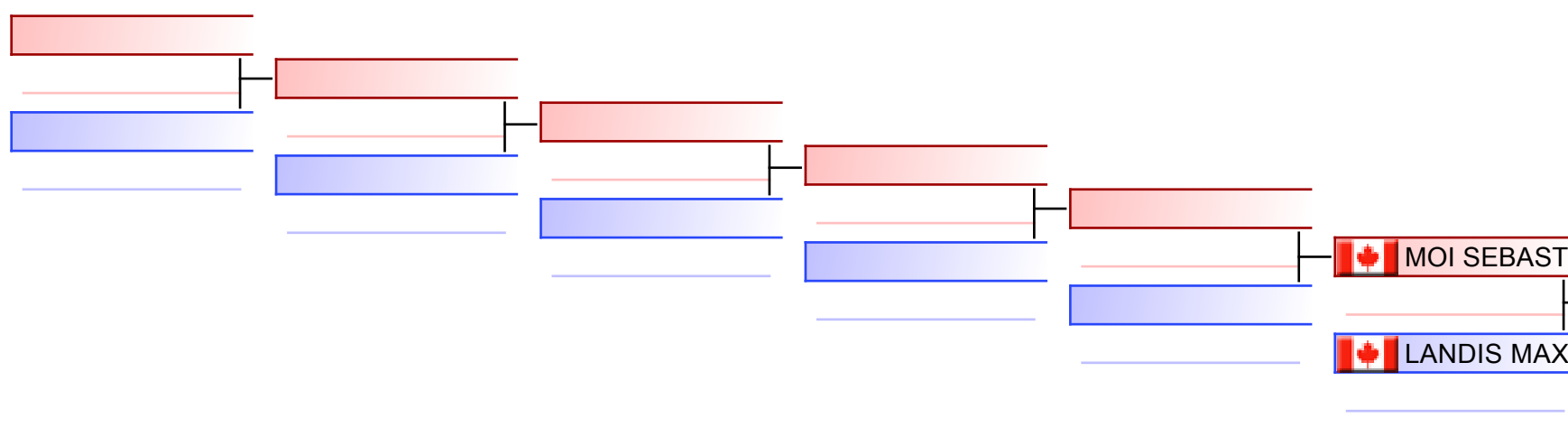

MOI SEBASTIAN (SHITO-RYU INTERNATIONAL RICHMOND DOJO, CAN) 3
 MOI SEBASTIAN (SHITO-RYU INTERNATIONAL RICHMOND DOJO, CAN) 3
 LANDIS MAXIMOS (ABBOTSFORD KARATE CLUB, CAN) 15
 BRYNJOLFSON HUDSON (KIMNIK SHOTOKAN KARATE DOJO, CAN) 0

Referees:							
-----------	--	--	--	--	--	--	--

RK-27 Boys 8/9 - Kata Intermediate

2019 Karate BC Provincial Championships, CAN

Tatami
5 11:10

Pool
1/1

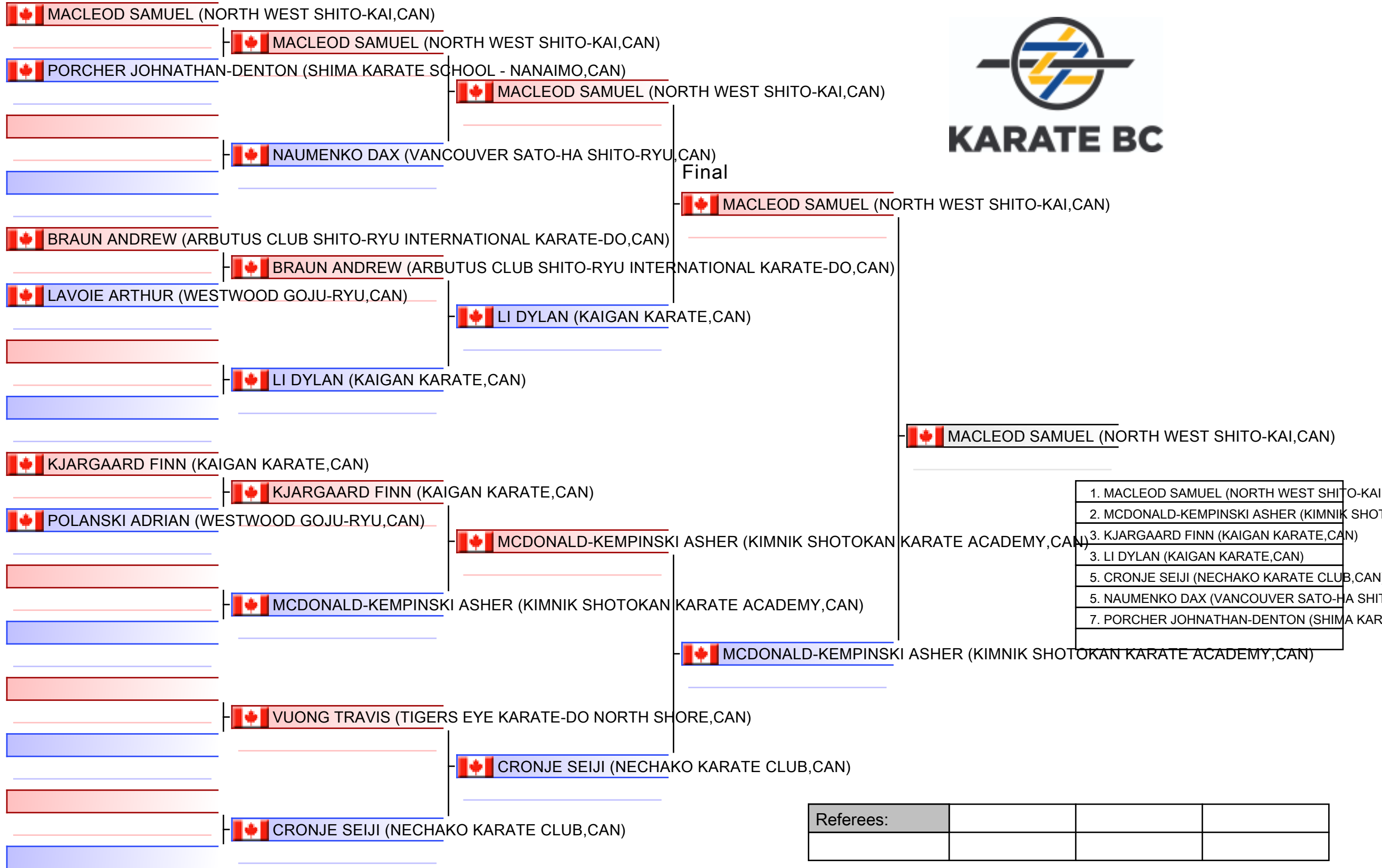

RK-27 Boys 8/9 - Kata Intermediate

2019 Karate BC Provincial Championships

Tatami
5 11:45

Pool
1

(c)sportdata GmbH & Co KG 2000-2019(2019-12-04 00:09) -WKF Approved- v 9.8.6 build 2 License: Karate BC (expire 2020-10-12)

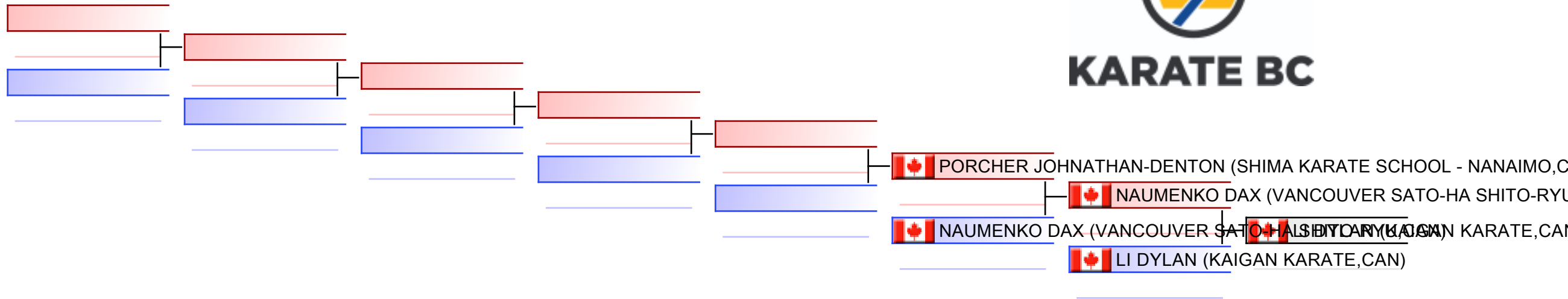

REPECHAGE: (1)

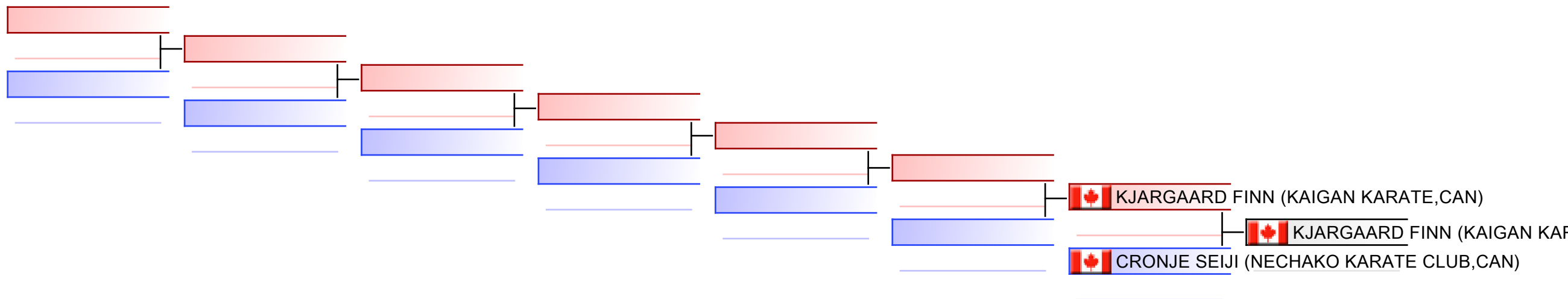

Referees:							
-----------	--	--	--	--	--	--	--



KARATE BC

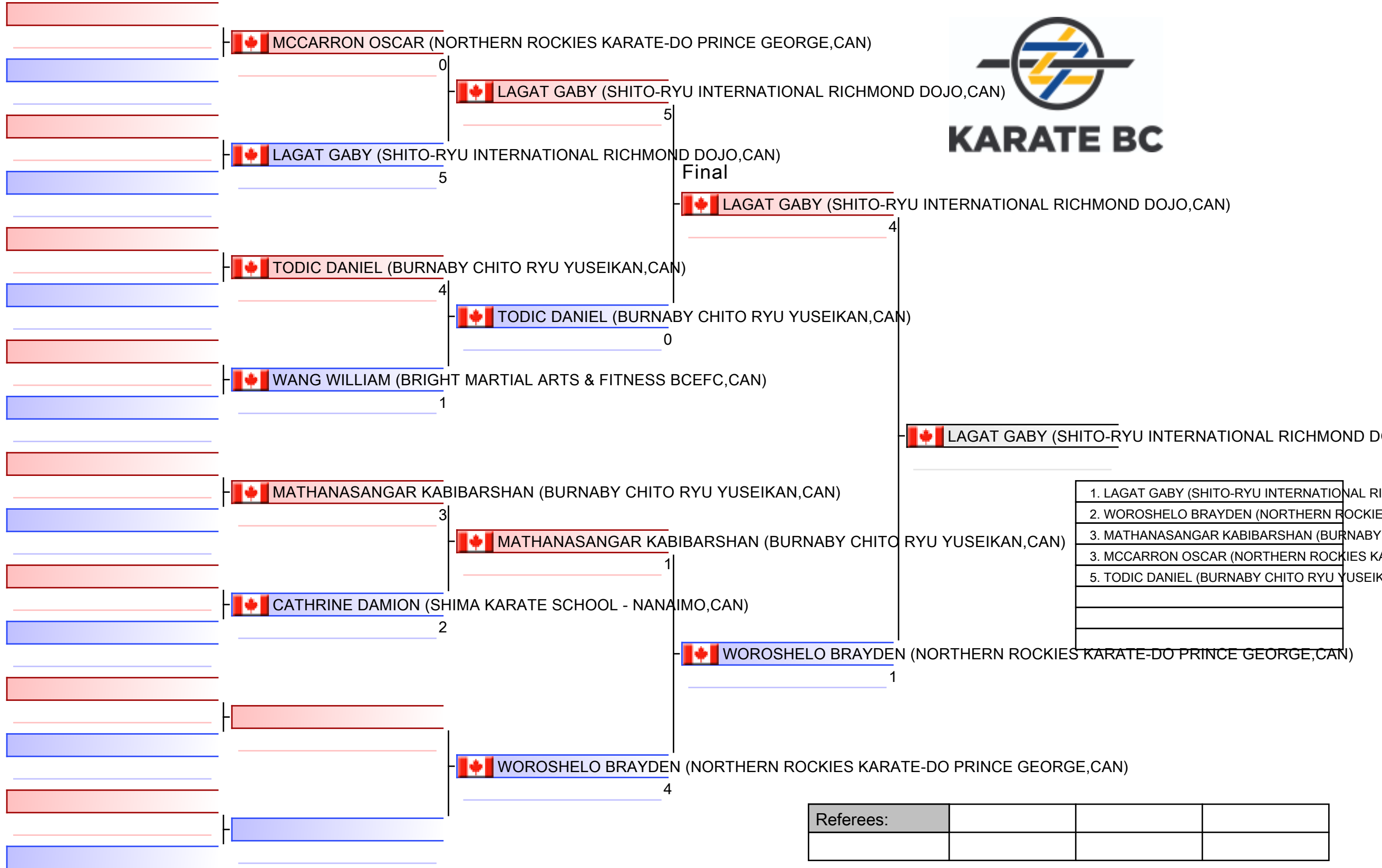

- | |
|--|
| 1. LAGAT GABY (SHITO-RYU INTERNATIONAL RICHMOND DOJO, CAN) |
| 2. WOROSHELO BRAYDEN (NORTHERN ROCKIES KARATE-DO PRINCE GEORGE, CAN) |
| 3. MATHANASANGAR KABIBARSHAN (BURNABY CHITO RYU YUSEIKAN, CAN) |
| 3. MCCARRON OSCAR (NORTHERN ROCKIES KARATE-DO PRINCE GEORGE, CAN) |
| 5. TODIC DANIEL (BURNABY CHITO RYU YUSEIKAN, CAN) |
| |
| |
| |

Referees:			

RK-29 Boys 10/11 - Kata Novice



2019 Karate BC Provincial Championships

(c)sportdata GmbH & Co KG 2000-2019(2019-12-04 00:09) -WKF Approved- v 9.8.6 build 2 License: Karate BC (expire 2020-10-12)

Tatami
1 10:20

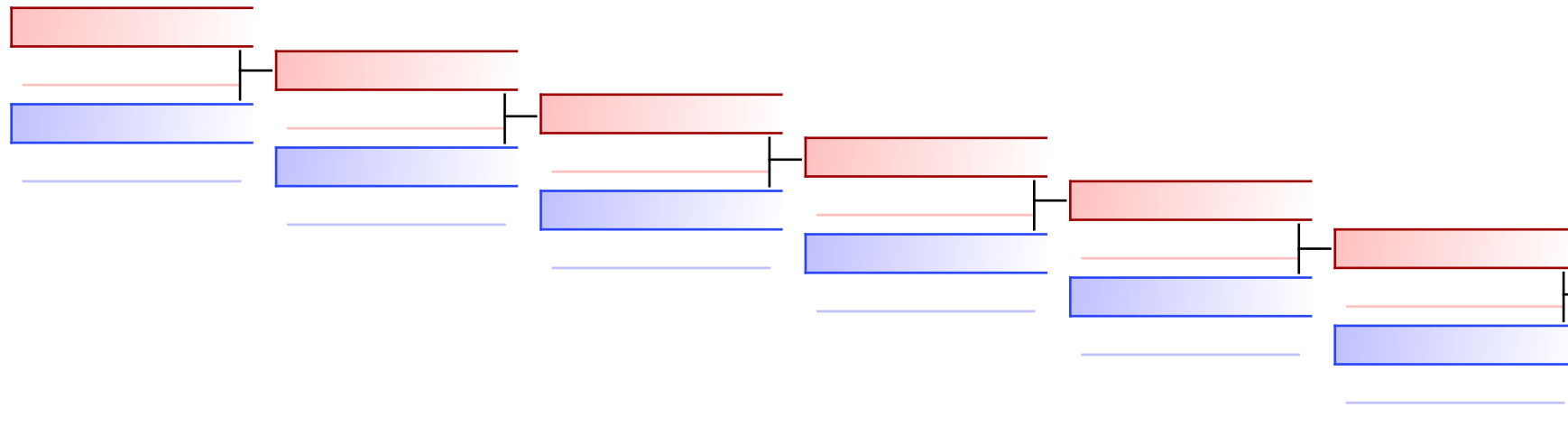
Pool
1



 MCCARRON OSCAR (NORTHERN ROCKIES KARATE-
 MCCARRON OSCAR (NORTHERN
 TODIC DANIEL (BURNABY CHITO RYU YUSEIKAN, CA
 4
 1

REPECHAGE: (1)

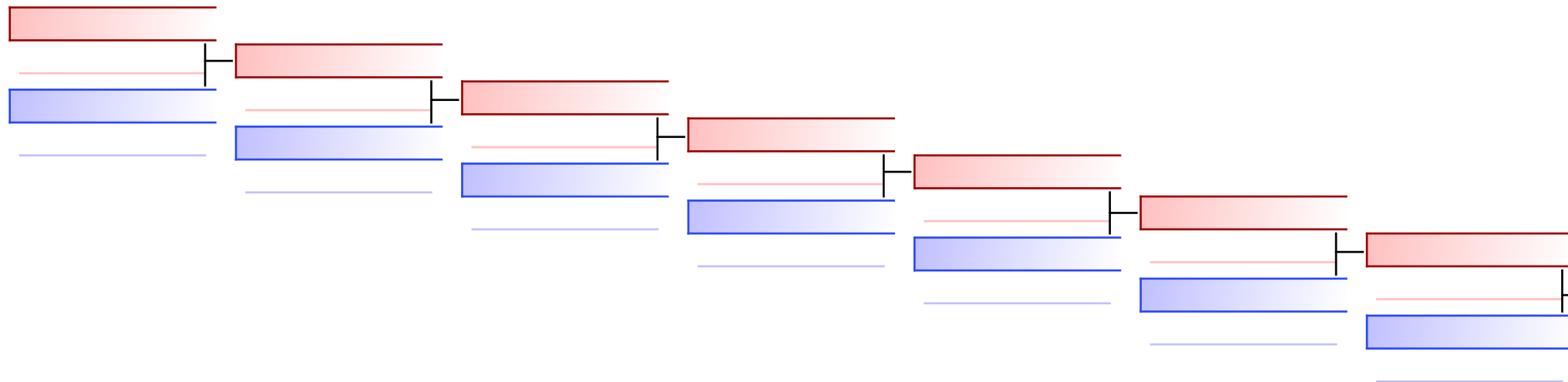

 MATHANASANGAR KABIBARSH









Referees:							
-----------	--	--	--	--	--	--	--

RK-2 Girls 8/9 - Kata Novice - Round Robin (each against each)

2019 Karate BC Provincial Championships, CAN

Tatami
1 12:20

Pool
1/1

1	 FUNG ELISE (KINGSWAY SHITO-RYU,CAN)	5	 FUNG ELISE (KINGSWAY SHITO-RYU,CAN)
2	 SNOW-KIMURA MIA (KINGSWAY SHITO-RYU,CAN)	0	
3	 FUNG ELISE (KINGSWAY SHITO-RYU,CAN)	3	 FUNG ELISE (KINGSWAY SHITO-RYU,CAN)
4	 SCOTT JAIMEE (NORTH WEST SHITO-KAI,CAN)	2	
5	 SNOW-KIMURA MIA (KINGSWAY SHITO-RYU,CAN)	1	 SCOTT JAIMEE (NORTH WEST SHITO-KAI,CAN)
6	 SCOTT JAIMEE (NORTH WEST SHITO-KAI,CAN)	4	



1. FUNG ELISE (KINGSWAY SHITO-RYU,CAN)
2. SCOTT JAIMEE (NORTH WEST SHITO-KAI,CAN)
3. SNOW-KIMURA MIA (KINGSWAY SHITO-RYU,CAN)

Referees:			

RK-30 Split 1 Boys 11 - Kata Intermediate

2019 Karate BC Provincial Championships, CAN

Tatami
2 10:15

Pool
1/1

 RATTI ARYAN (WEST RIVER,CAN)

5 |  RATTI ARYAN (WEST RIVER,CAN)

 WU HAN (WHITE ROCK GIMA-HA SHOTOKAN-RYU,CAN)

0 |  RATTI ARYAN (WEST RIVER,CAN)

3 |  TUBBS DEVON (ABBOTSFORD KARATE CLUB,CAN)

1 |  TUBBS DEVON (ABBOTSFORD KARATE CLUB,CAN)

 MCFEE EVAN (CAMPBELL RIVER WADO,CAN)

2 |  WONG MATIAS (BRIGHT MARTIAL ARTS & FITNESS,CAN)

 WONG MATIAS (BRIGHT MARTIAL ARTS & FITNESS,CAN)

3 |  WONG MATIAS (BRIGHT MARTIAL ARTS & FITNESS,CAN)

2 |  HENDERSON NEIL (NORTHERN ROCKIES KARATE-DO PRINCE GEORGE,CAN)

2 |  HENDERSON NEIL (NORTHERN ROCKIES KARATE-DO PRINCE GEORGE,CAN)

 NAGAWKAR NISSIM (KINGSWAY SHITO-RYU,CAN)

2 |  WORT ETHAN (KAIGAN KARATE,CAN)

 WORT ETHAN (KAIGAN KARATE,CAN)

3 |  WORT ETHAN (KAIGAN KARATE,CAN)

5 |  WORT ETHAN (KAIGAN KARATE,CAN)

0 |  YUNG NATHAN (BRIGHT MARTIAL ARTS & FITNESS,CAN)

0 |  YUNG NATHAN (BRIGHT MARTIAL ARTS & FITNESS,CAN)

 JOHNSTONE KEVIN (SHIMA KARATE SCHOOL - NANAIMO,CAN)

1 |  WYNNE STORM (RODNEY HOBSON KARATE ACADEMY,CAN)

 WYNNE STORM (RODNEY HOBSON KARATE ACADEMY,CAN)

4 |  MCDONALD-KEMPINSKI HAYDEN (KIMNIK SHOTOKAN KARATE ACADEMY,CAN)

0 |  MCDONALD-KEMPINSKI HAYDEN (KIMNIK SHOTOKAN KARATE ACADEMY,CAN)

4 |  MCDONALD-KEMPINSKI HAYDEN (KIMNIK SHOTOKAN KARATE ACADEMY,CAN)

Final

 RATTI ARYAN (WEST RIVER,CAN)

0 |  RATTI ARYAN (WEST RIVER,CAN)

 WORT ETHAN (KAIGAN KARATE,CAN)

- | |
|---|
| 1. WORT ETHAN (KAIGAN KARATE,CAN) |
| 2. RATTI ARYAN (WEST RIVER,CAN) |
| 3. WONG MATIAS (BRIGHT MARTIAL ARTS & FITNESS,CAN) |
| 3. NAGAWKAR NISSIM (KINGSWAY SHITO-RYU,CAN) |
| 5. WU HAN (WHITE ROCK GIMA-HA SHOTOKAN-RYU,CAN) |
| 5. MCDONALD-KEMPINSKI HAYDEN (KIMNIK SHOTOKAN KARATE ACADEMY,CAN) |
| 7. TUBBS DEVON (ABBOTSFORD KARATE CLUB,CAN) |
| 7. YUNG NATHAN (BRIGHT MARTIAL ARTS & FITNESS,CAN) |

Referees:			



RK-30 Split 1 Boys 11 - Kata Intermediate

2019 Karate BC Provincial Championships

Tatami
2 10:50

Pool
1

(c)sportdata GmbH & Co KG 2000-2019(2019-12-04 00:09) -WKF Approved- v 9.8.6 build 2 License: Karate BC (expire 2020-10-12)

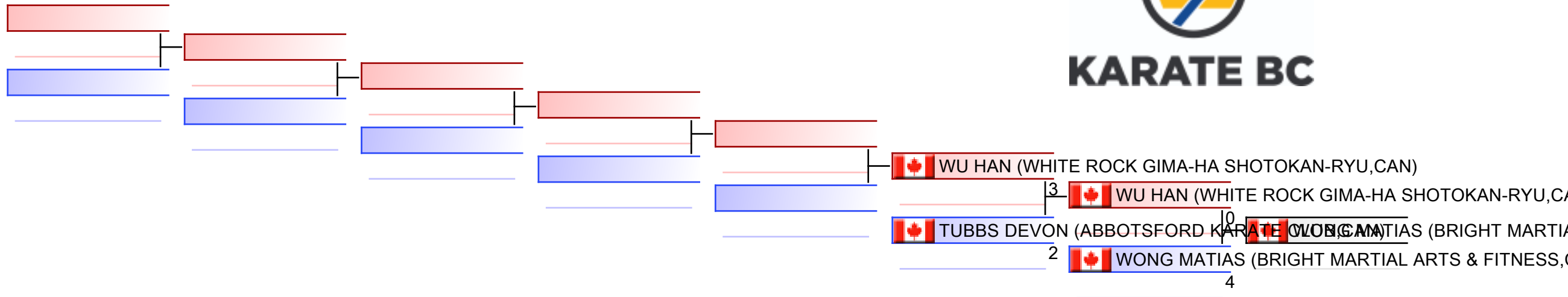

REPECHAGE: (1)

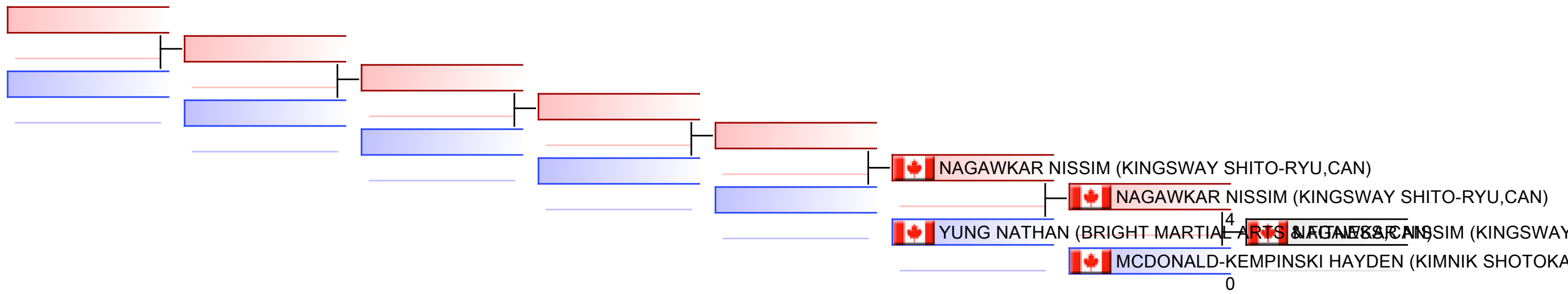

Referees:							
-----------	--	--	--	--	--	--	--

RK-30 Split 2 Boys 10 - Kata Intermediate

2019 Karate BC Provincial Championships, CAN

Tatami
1 10:35

Pool
1/1

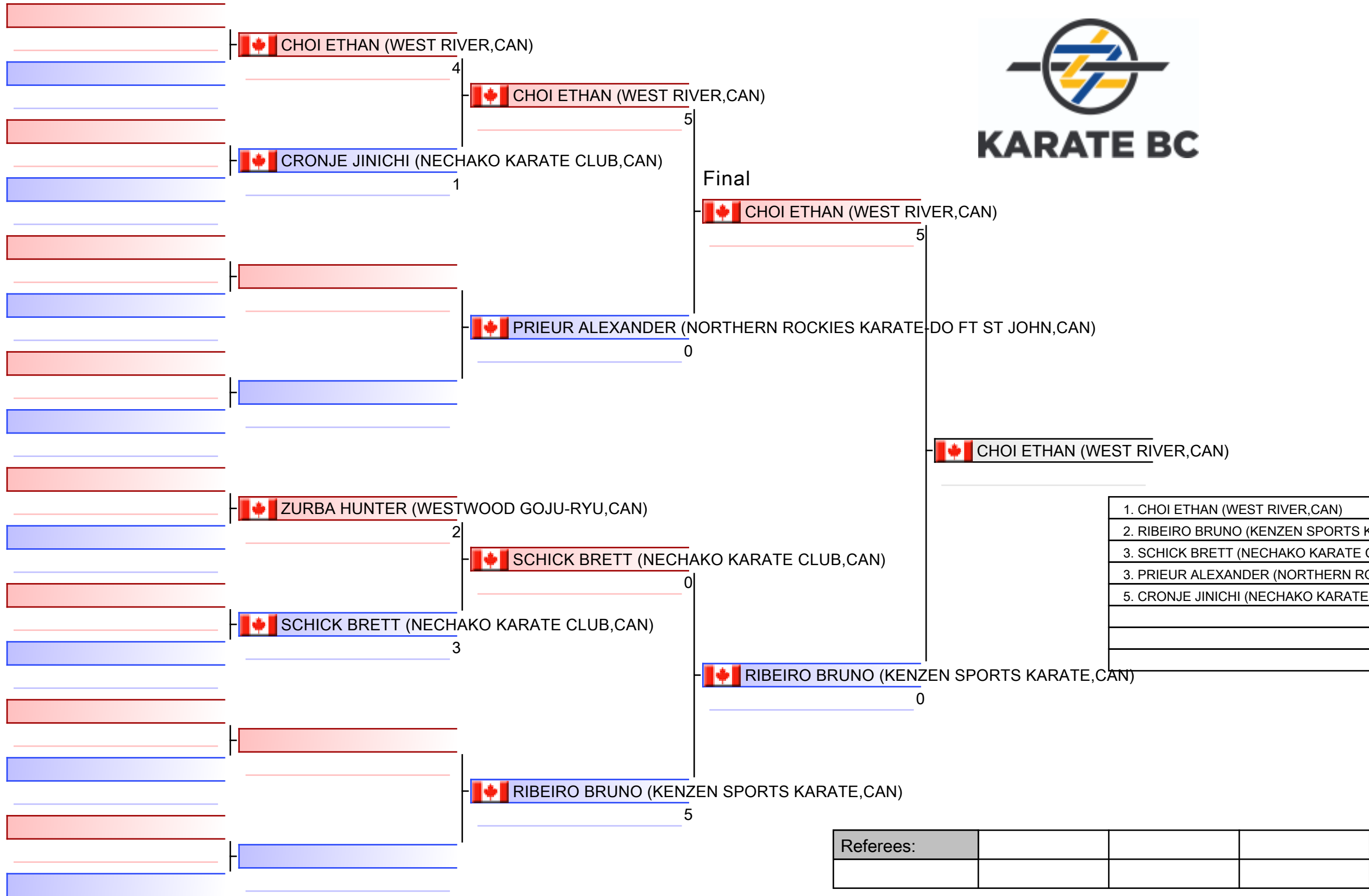

RK-30 Split 2 Boys 10 - Kata Intermediate

2019 Karate BC Provincial Championships

(c)sportdata GmbH & Co KG 2000-2019(2019-12-04 00:09) -WKF Approved- v 9.8.6 build 2 License: Karate BC (expire 2020-10-12)

Tatami
1 10:50

Pool
1

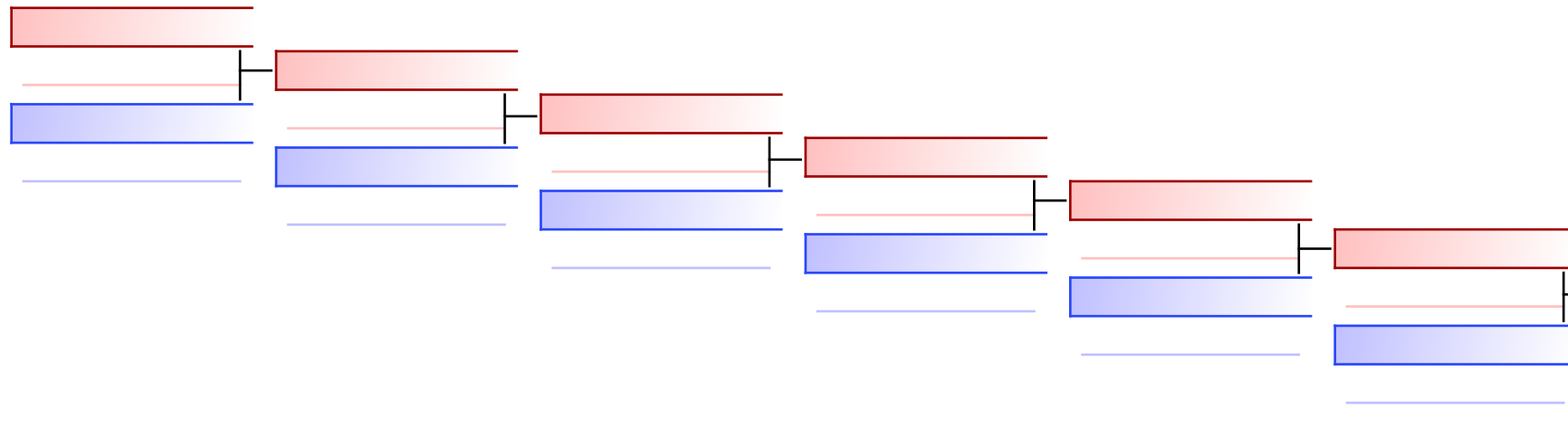

CRONJE JINICHI (NECHAKO KARATE CLUB,CAN)
 1
 PRIEUR ALEXANDER (NORTHERN ROCKIES KARATE)
 4

REPECHAGE: (1)

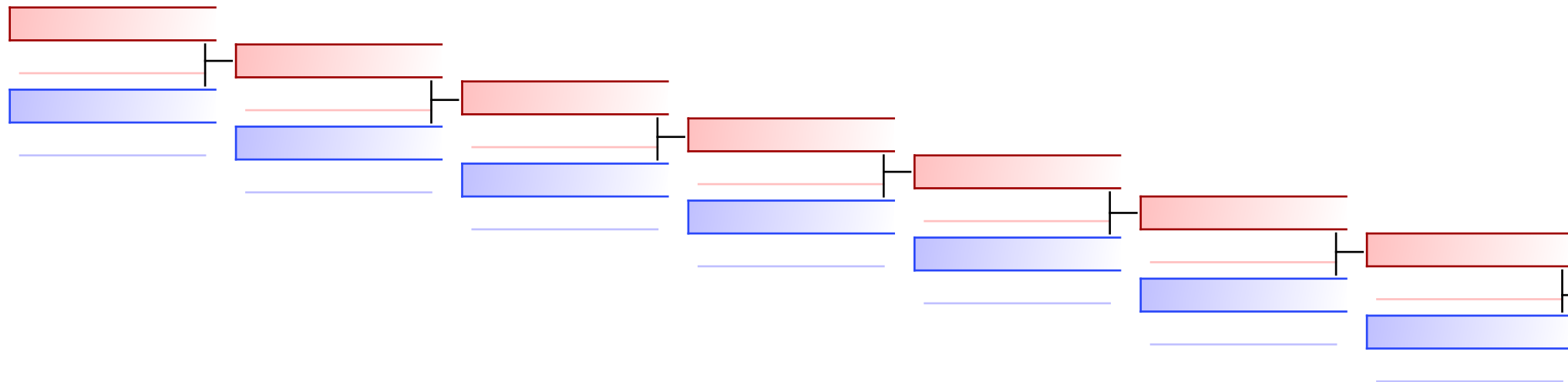

SCHICK BRETT (NECHAKO KARATE)

Referees:							
-----------	--	--	--	--	--	--	--

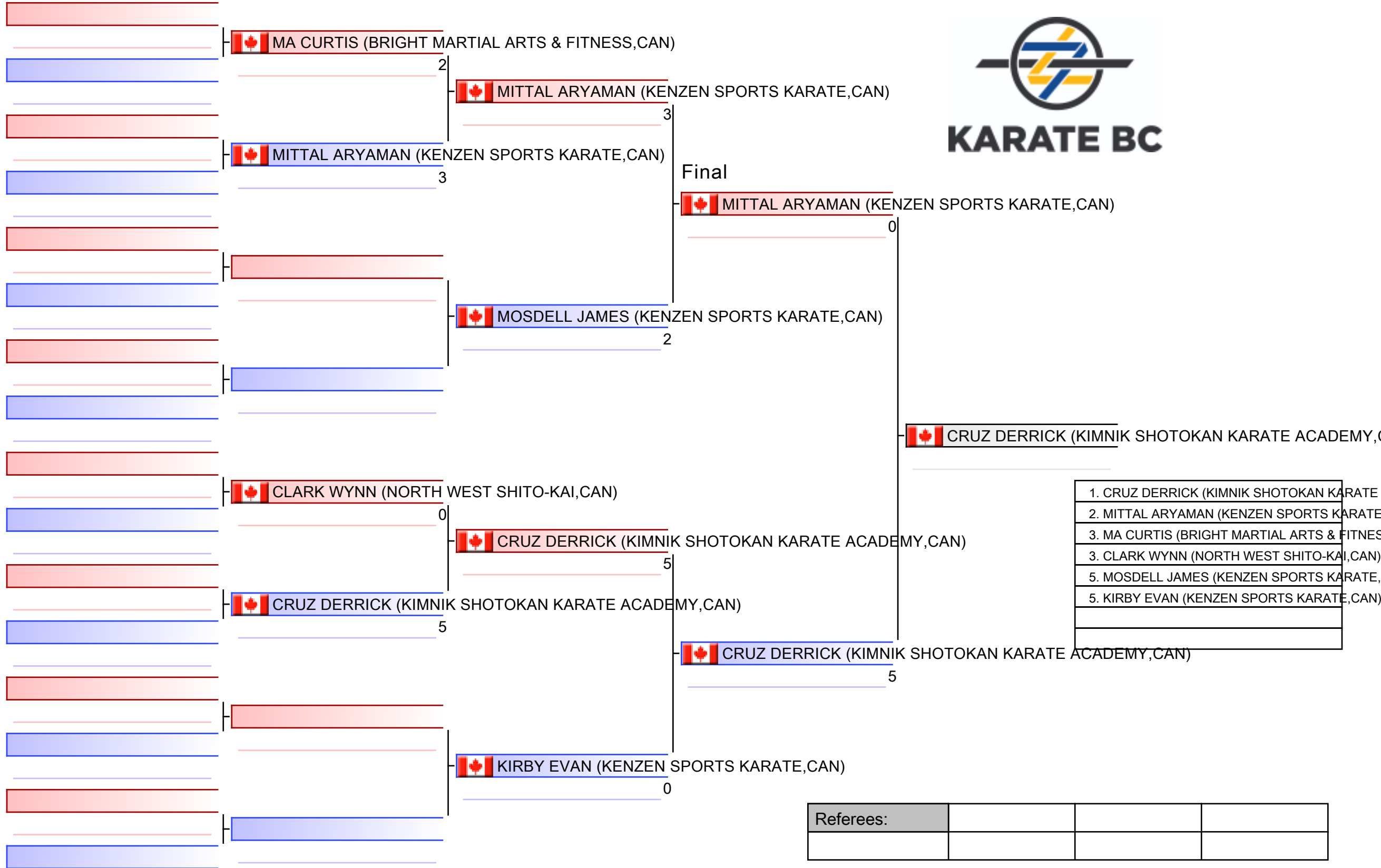

RK-31 Boys 10/11 - Kata Adv/Black

2019 Karate BC Provincial Championships

(c)sportdata GmbH & Co KG 2000-2019(2019-12-04 00:09) -WKF Approved- v 9.8.6 build 2 License: Karate BC (expire 2020-10-12)

Tatami
3 10:30

Pool
1

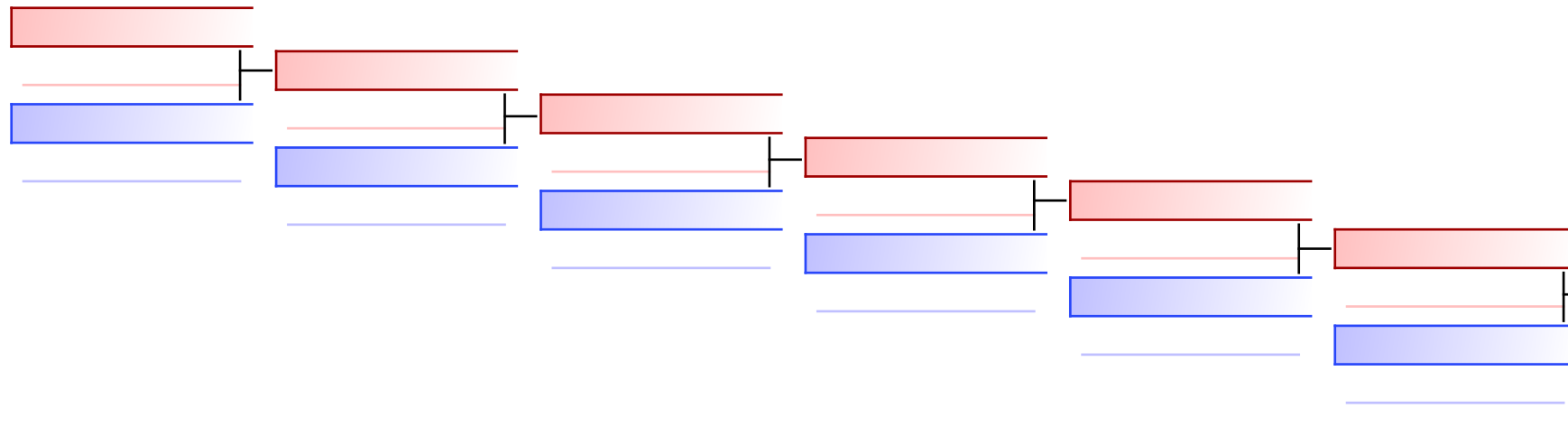

MA CURTIS (BRIGHT MARTIAL ARTS & FITNESS,CAN)
 3
 MA CURTIS (BRIGHT MARTIAL A
 MOSDELL JAMES (KENZEN SPORTS KARATE,CAN)
 2

REPECHAGE: (1)

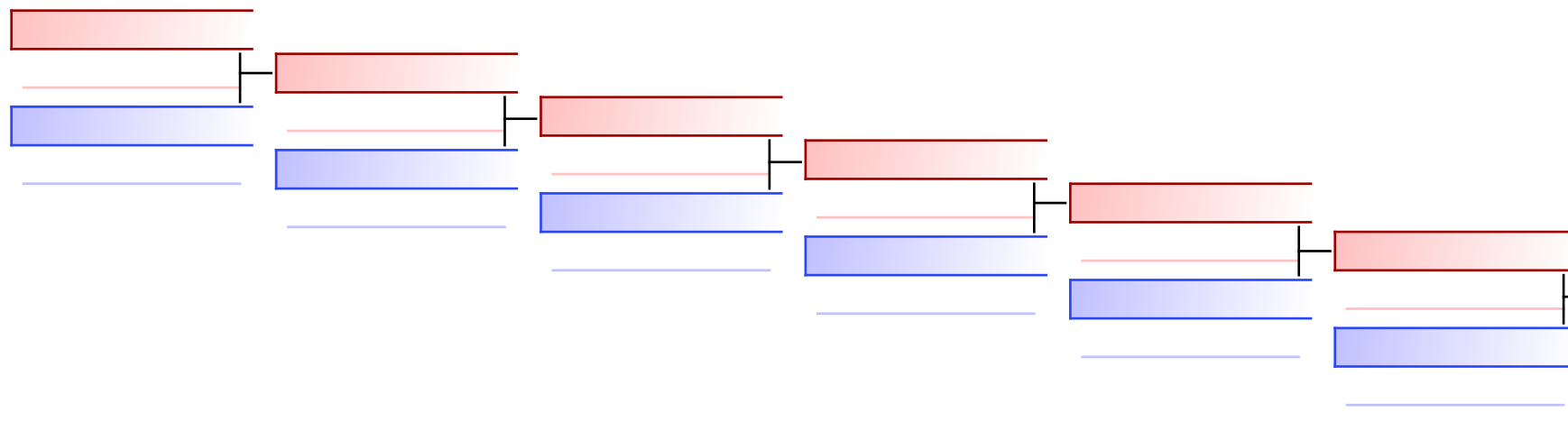

CLARK WYNN (NORTH WEST SHITO-KAI,CAN)
 4
 CLARK WYNN (NORTH WEST SH
 KIRBY EVAN (KENZEN SPORTS KARATE,CAN)
 1

Referees:							
-----------	--	--	--	--	--	--	--

RK-33 Boys 12/13 - Kata Intermediate

2019 Karate BC Provincial Championships, CAN

Tatami
5 10:05

Pool
1/1

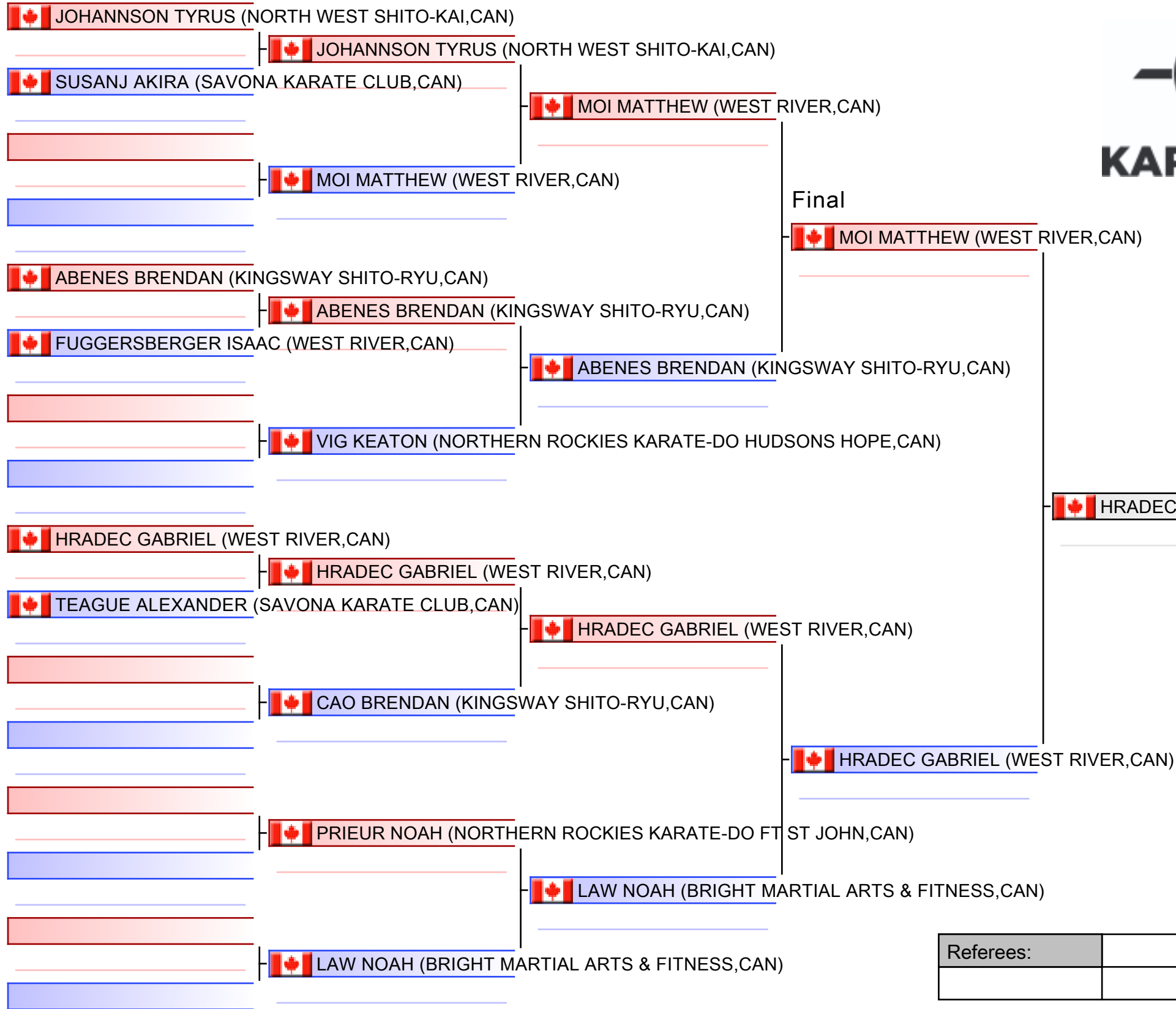

- | |
|---|
| 1. HRADEC GABRIEL (WEST RIVER,CAN) |
| 2. MOI MATTHEW (WEST RIVER,CAN) |
| 3. ABENES BRENDAN (KINGSWAY SHITO-RYU,CAN) |
| 3. CAO BRENDAN (KINGSWAY SHITO-RYU,CAN) |
| 5. JOHANNSON TYRUS (NORTH WEST SHITO-KAI,CAN) |
| 5. LAW NOAH (BRIGHT MARTIAL ARTS & FITNESS,CAN) |
| 7. TEAGUE ALEXANDER (SAVONA KARATE CLUB,CAN) |

Referees:			

RK-33 Boys 12/13 - Kata Intermediate

2019 Karate BC Provincial Championships

Tatami
5 10:40

Pool
1

(c)sportdata GmbH & Co KG 2000-2019(2019-12-04 00:09) -WKF Approved- v 9.8.6 build 2 License: Karate BC (expire 2020-10-12)

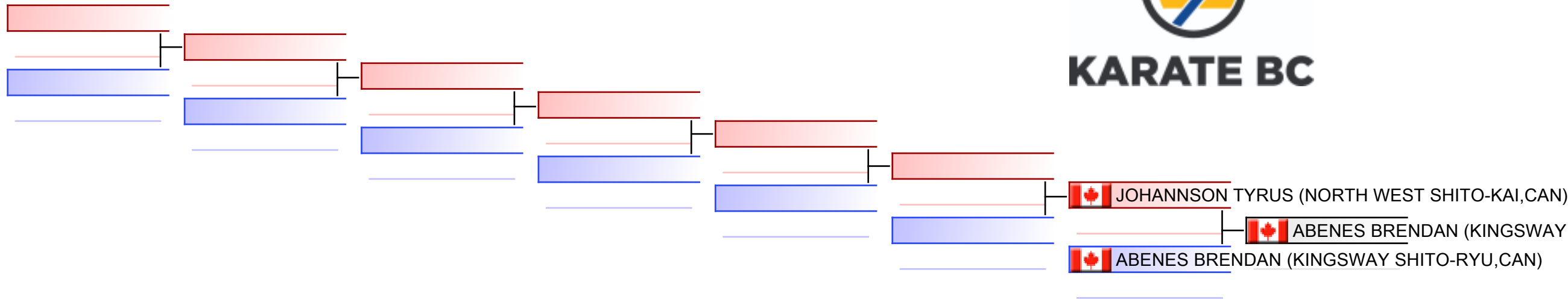

REPECHAGE: (1)

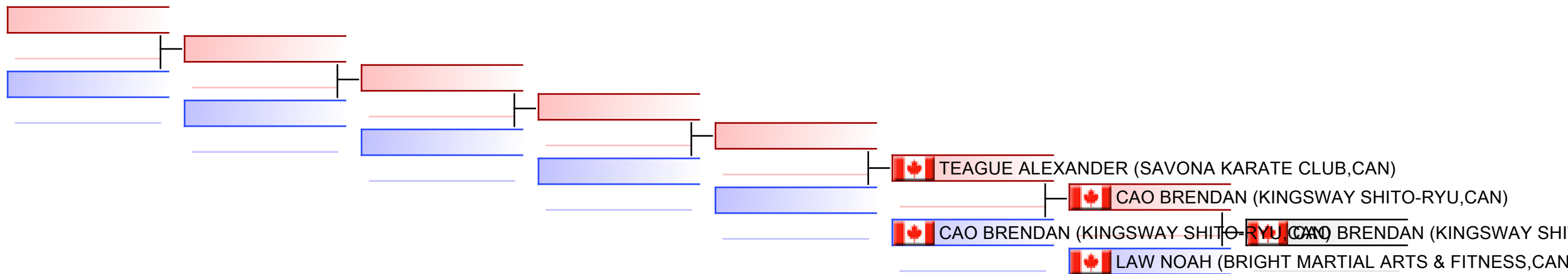



Referees:							
-----------	--	--	--	--	--	--	--

RK-34 Boys 12/13 - Kata Adv/Black - Round Robin (each against each)



2019 Karate BC Provincial Championships, CAN

Tatami
5 09:55



Pool
1/1

- 1  EZAKI HIKARU (WHITE ROCK GIMA-HA SHOTOKAN-RYU,CAN)
|  LO JONAS (THOMPSON KARATE CLUB,CAN)

- 2  LO JONAS (THOMPSON KARATE CLUB,CAN)

- 3  EZAKI HIKARU (WHITE ROCK GIMA-HA SHOTOKAN-RYU,CAN)
|  BELANGER JULIEN (WESTWOOD GOJU-RYU,CAN)

- 4  BELANGER JULIEN (WESTWOOD GOJU-RYU,CAN)

- 5  LO JONAS (THOMPSON KARATE CLUB,CAN)
|  BELANGER JULIEN (WESTWOOD GOJU-RYU,CAN)

- 6  BELANGER JULIEN (WESTWOOD GOJU-RYU,CAN)



1. BELANGER JULIEN (WESTWOOD GOJU-RYU,CAN)
2. LO JONAS (THOMPSON KARATE CLUB,CAN)
3. EZAKI HIKARU (WHITE ROCK GIMA-HA SHOTO

Referees:				

RK-36 Boys 14/15 - Kata Intermediate

2019 Karate BC Provincial Championships, CAN

Tatami
3 09:30

Pool
1/1

 FUGGERSBERGER MICAH (WEST RIVER,CAN)

1|  TAKAHASHI EISHI (WHITE ROCK GIMA-HA SHOTOKAN-RYU,CAN)

 TAKAHASHI EISHI (WHITE ROCK GIMA-HA SHOTOKAN-RYU,CAN)

4|  TAKAHASHI EISHI (WHITE ROCK GIMA-HA SHOTOKAN-RYU,CAN)

 ABENES ANTHONY (KINGSWAY SHITO-RYU,CAN)

0|

 ATHERTON BENJAMIN (TANEDA DOJO PENTICTON CHITO-RYU,CAN)

2|

 GANT JOSH (KENZEN SPORTS KARATE,CAN)

2|

 GANT JOSH (KENZEN SPORTS KARATE,CAN)

3|

 DAVIS JAYDON (TANEDA DOJO SUMMERLAND CHITO-RYU,CAN)

2|

 JOSS JAMES (KIMNIK SHOTOKAN KARATE ACADEMY,CAN)

1|

 JOSS JAMES (KIMNIK SHOTOKAN KARATE ACADEMY,CAN)

3|

 PATEL RAJ (KINGSWAY SHITO-RYU,CAN)

0|

 ELFURJANI QABAS (UNIVERSITY OF VICTORIA SHOTOKAN,CAN)

0|

 PATEL RAJ (KINGSWAY SHITO-RYU,CAN)

4|

 PATEL RAJ (KINGSWAY SHITO-RYU,CAN)

5|



KARATE BC

Final

 TAKAHASHI EISHI (WHITE ROCK GIMA-HA SHOTOKAN-RYU,CAN)

5|

 TAKAHASHI EISHI (WHITE ROCK GIMA-HA SHOTOKAN-RYU,CAN)

- | |
|--|
| 1. TAKAHASHI EISHI (WHITE ROCK GIMA-HA SHOTOKAN-RYU,CAN) |
| 2. PATEL RAJ (KINGSWAY SHITO-RYU,CAN) |
| 3. JOSS JAMES (KIMNIK SHOTOKAN KARATE ACADEMY,CAN) |
| 3. ABENES ANTHONY (KINGSWAY SHITO-RYU,CAN) |
| 5. ELFURJANI QABAS (UNIVERSITY OF VICTORIA SHOTOKAN,CAN) |
| 5. GANT JOSH (KENZEN SPORTS KARATE,CAN) |
| 7. FUGGERSBERGER MICAH (WEST RIVER,CAN) |

Referees:			

RK-36 Boys 14/15 - Kata Intermediate

2019 Karate BC Provincial Championships

Tatami
3 09:55

Pool
1

(c)sportdata GmbH & Co KG 2000-2019(2019-12-04 00:09) -WKF Approved- v 9.8.6 build 2 License: Karate BC (expire 2020-10-12)

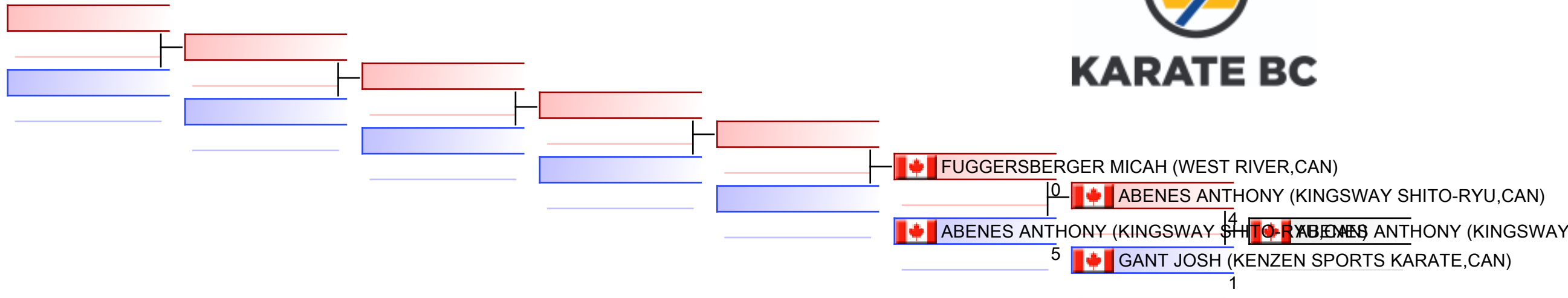

REPECHAGE: (1)

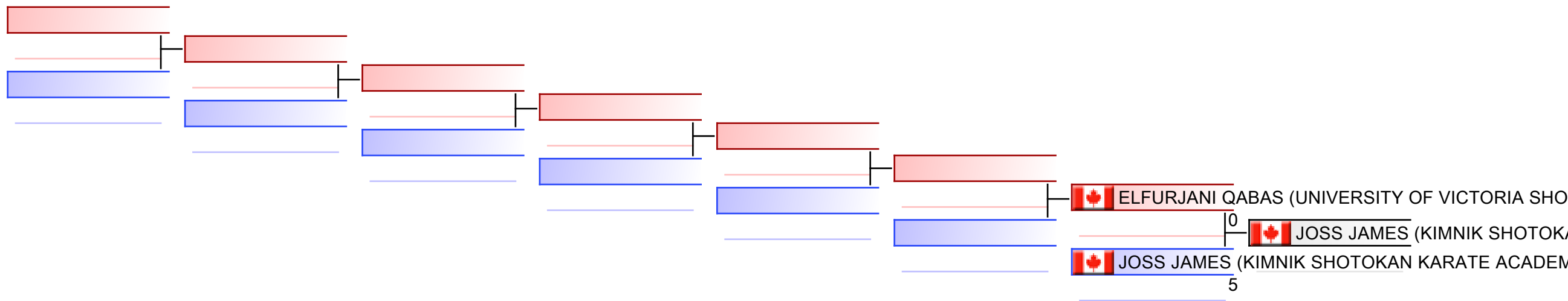

Referees:							
-----------	--	--	--	--	--	--	--



KARATE BC

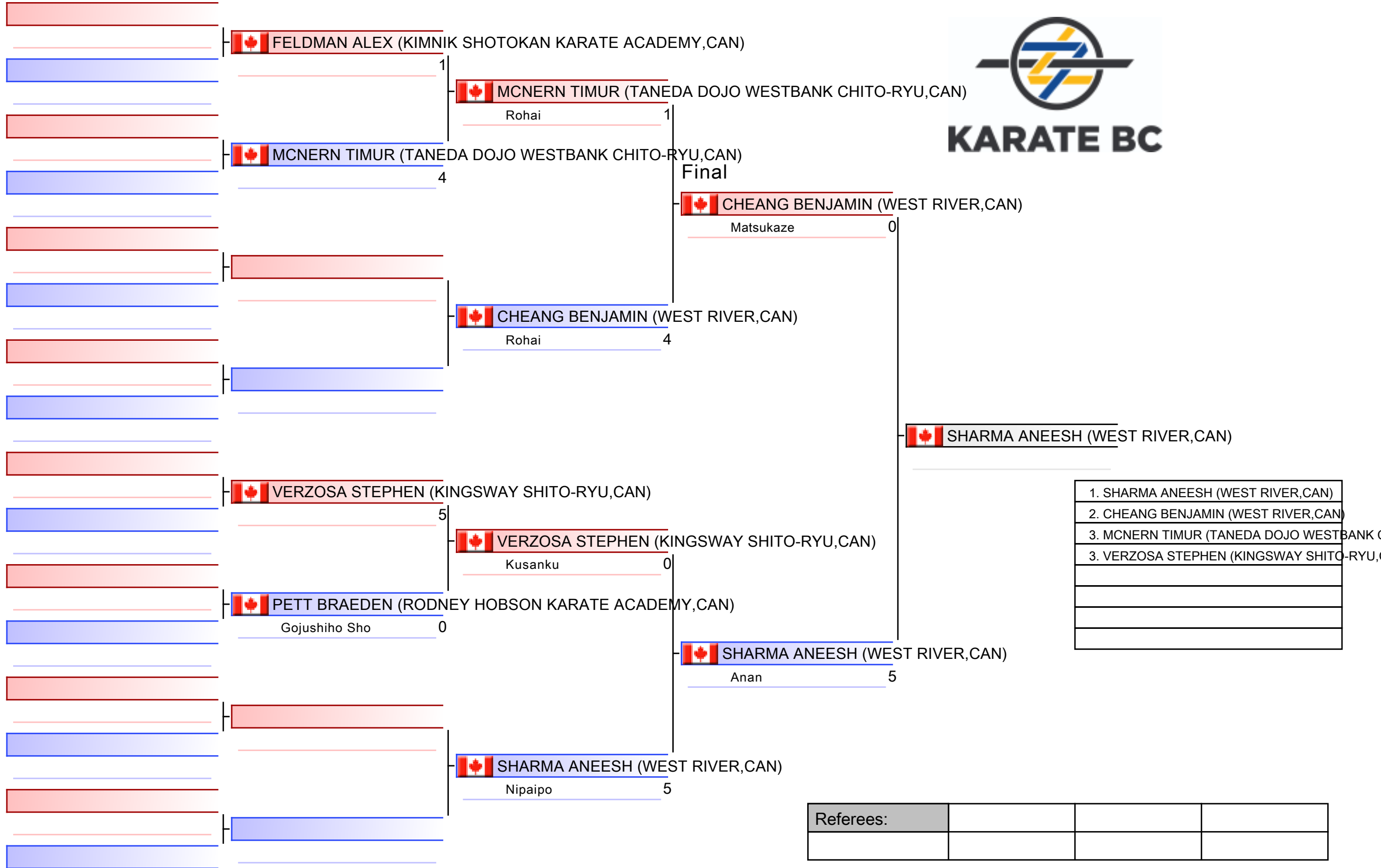

1. SHARMA ANEESH (WEST RIVER,CAN)
2. CHEANG BENJAMIN (WEST RIVER,CAN)
3. MCNERN TIMUR (TANEDA DOJO WESTBANK C
3. VERZOSA STEPHEN (KINGSWAY SHITO-RYU,C

Referees:			

RK-37 Boys 14/15 Kata Adv/Black

2019 Karate BC Provincial Championships

Tatami
4 09:45

Pool
1

(c)sportdata GmbH & Co KG 2000-2019(2019-12-04 00:10) -WKF Approved- v 9.8.6 build 2 License: Karate BC (expire 2020-10-12)

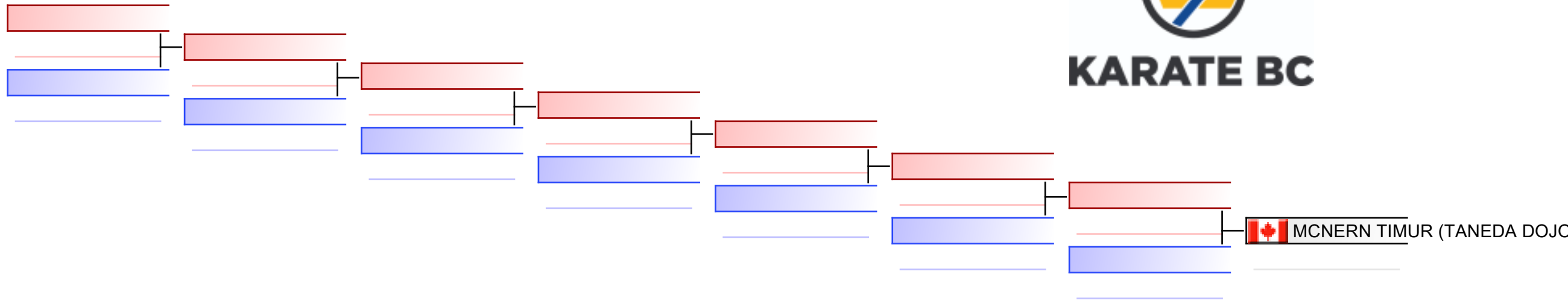

REPECHAGE: (1)

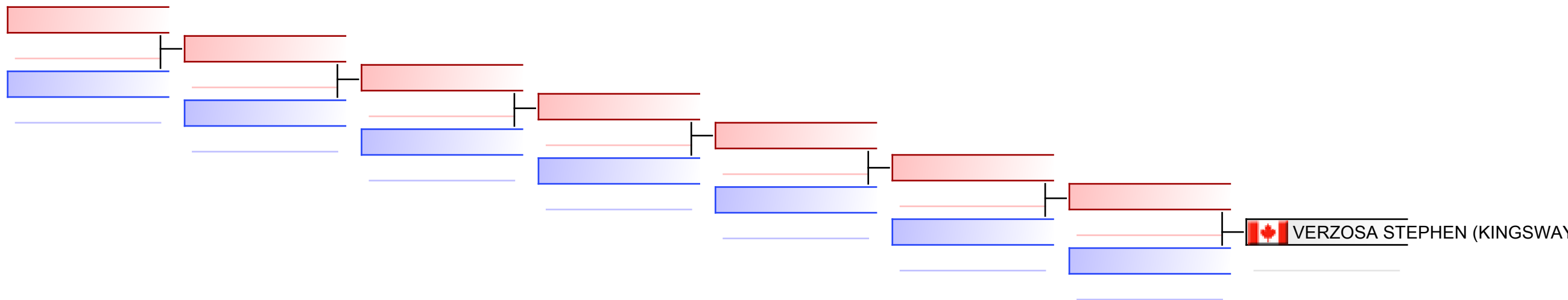

Referees:							
-----------	--	--	--	--	--	--	--

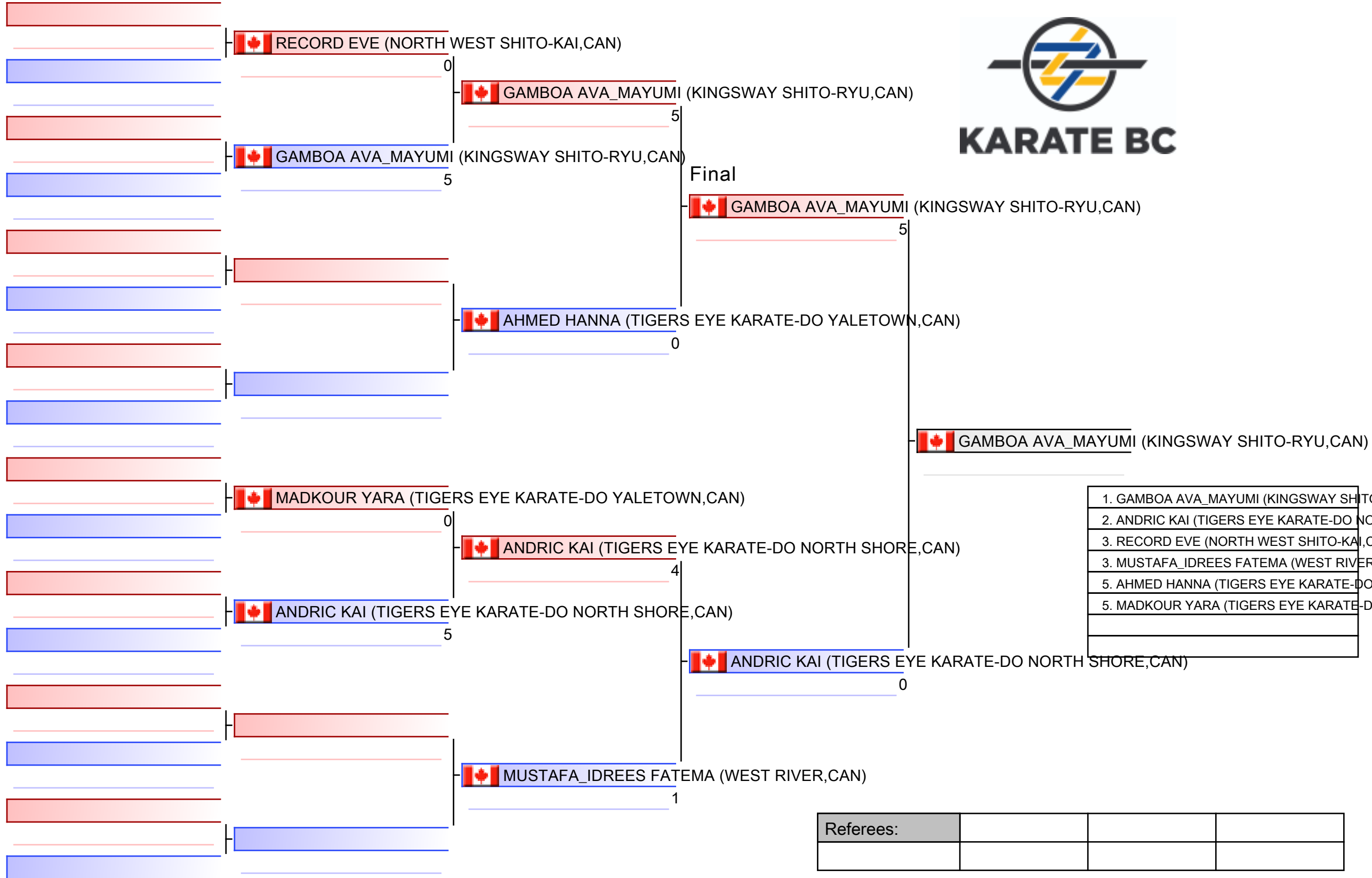

RK-3 Girls 8/9 - Kata Intermediate

2019 Karate BC Provincial Championships

Tatami
4 11:45

Pool
1

(c)sportdata GmbH & Co KG 2000-2019(2019-12-04 00:09) -WKF Approved- v 9.8.6 build 2 License: Karate BC (expire 2020-10-12)

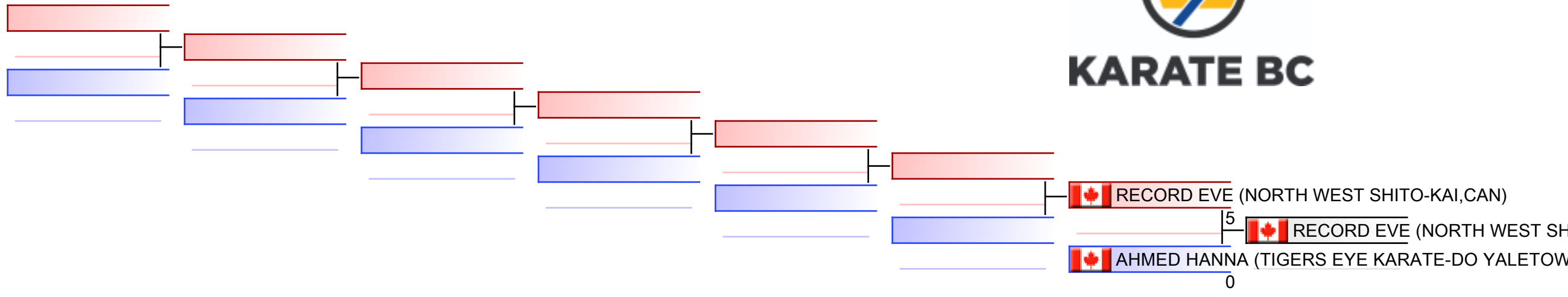

REPECHAGE: (1)

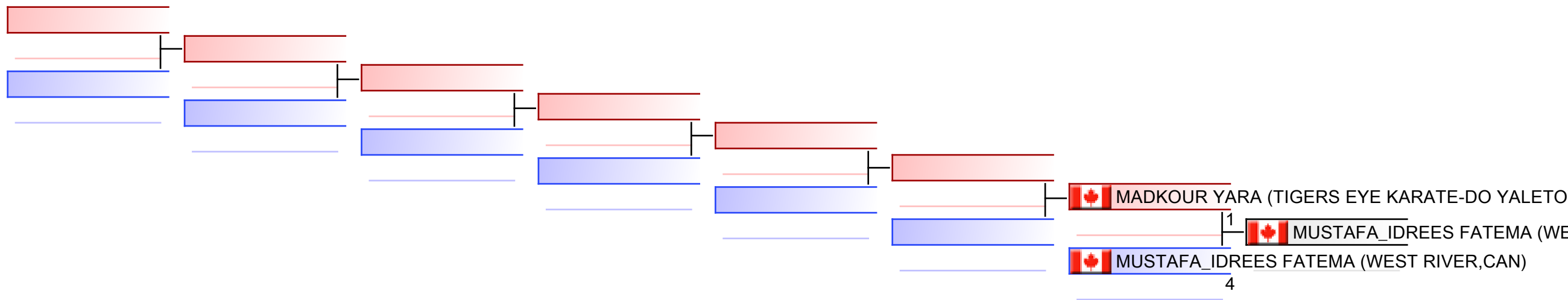









Referees:							
-----------	--	--	--	--	--	--	--

RK-43 Mens Kata Intermediate - Round Robin (each against each)

2019 Karate BC Provincial Championships, CAN

Tatami
1 13:00

Pool
1/1

- 1  **CHOI JASON (WEST RIVER,CAN)**
5 |  **CHOI JASON (WEST RIVER,CAN)**
- 2  **QUAALE LLOYD (KUMAKAI KARATE VANCOUVER,CAN)**
0
- 3  **CHOI JASON (WEST RIVER,CAN)**
4 |  **CHOI JASON (WEST RIVER,CAN)**
- 4  **POLANSKI MICHAL (WESTWOOD GOJU-RYU,CAN)**
1
- 5  **QUAALE LLOYD (KUMAKAI KARATE VANCOUVER,CAN)**
4 |  **QUAALE LLOYD (KUMAKAI KARATE VANCOUVER,CAN)**
- 6  **POLANSKI MICHAL (WESTWOOD GOJU-RYU,CAN)**
1



1. CHOI JASON (WEST RIVER,CAN)
2. QUAALE LLOYD (KUMAKAI KARATE VANCOUVER,CAN)
3. POLANSKI MICHAL (WESTWOOD GOJU-RYU,CAN)

Referees:				

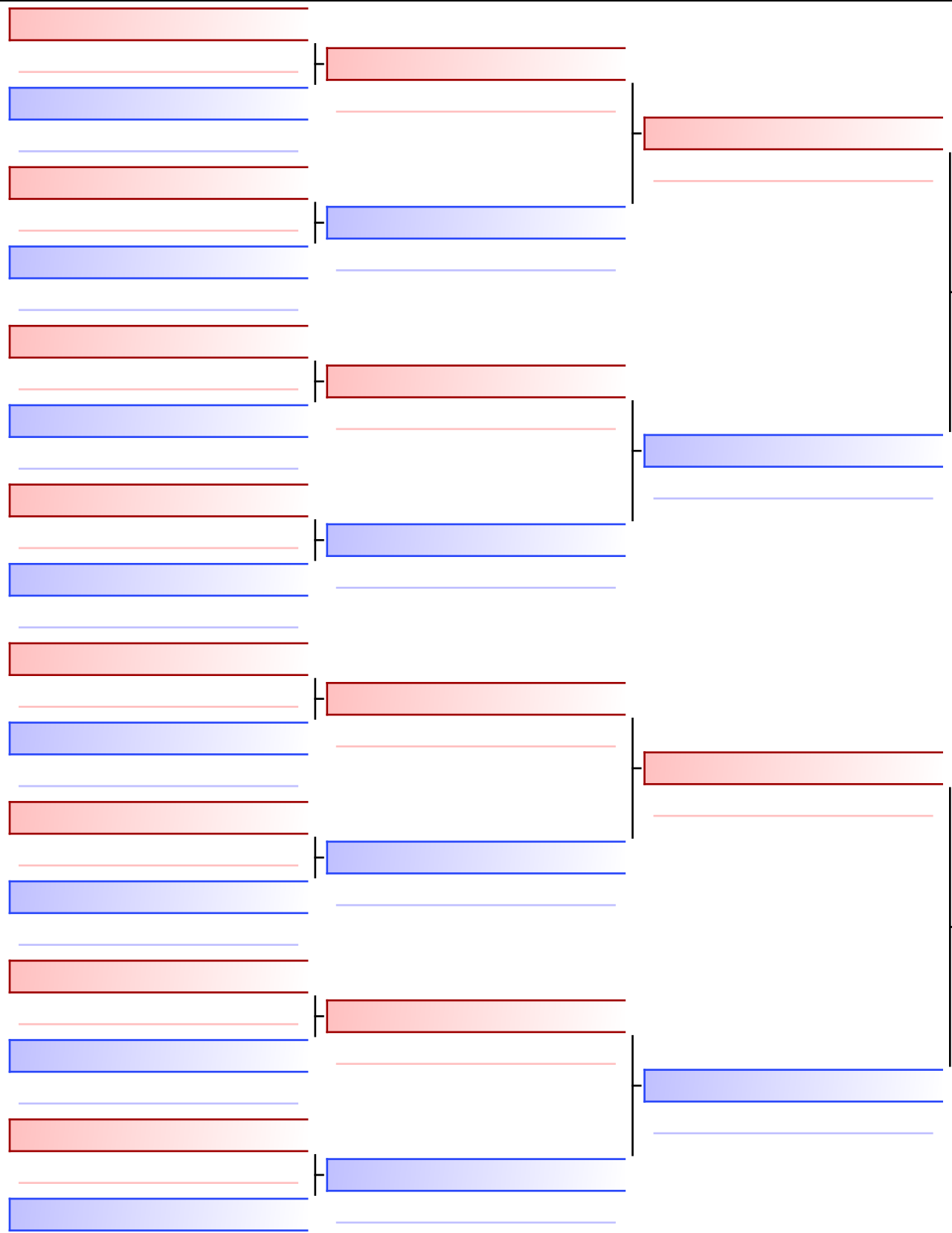

Final

STACEY JARETT (KINGSWAY SHITO-RYU,CAN)

1

ZURBA JASON (WESTWOOD GOJU-RYU,CAN)

ZURBA JASON (WESTWOOD GOJU-RYU,CAN)

4

1. ZURBA JASON (WESTWOOD GOJU-RYU,CAN)
2. STACEY JARETT (KINGSWAY SHITO-RYU,CAN)

Referees:			

RK-45 Mens Kata Black - Recreational - Round Robin (each against each)

2019 Karate BC Provincial Championships, CAN

Tatami
1 13:30

Pool
1/1

- 1 🇨🇦 CHEN MUTTE (SOUTH SURREY KARATE CLUB,CAN) 0 | 🇨🇦 NIKOLAISEN NIGEL (NORTH WEST SHITO-KAI,CAN)
- 2 🇨🇦 NIKOLAISEN NIGEL (NORTH WEST SHITO-KAI,CAN) 5 |
- 3 🇨🇦 CHEN MUTTE (SOUTH SURREY KARATE CLUB,CAN) 2 | 🇨🇦 ARAKAKI_NEVES KIMAR (WEST COAST GOJU-KAI,CAN)
- 4 🇨🇦 ARAKAKI_NEVES KIMAR (WEST COAST GOJU-KAI,CAN) 3 |
- 5 🇨🇦 NIKOLAISEN NIGEL (NORTH WEST SHITO-KAI,CAN) 5 | 🇨🇦 NIKOLAISEN NIGEL (NORTH WEST SHITO-KAI,CAN)
- 6 🇨🇦 ARAKAKI_NEVES KIMAR (WEST COAST GOJU-KAI,CAN) 0 |



1. NIKOLAISEN NIGEL (NORTH WEST SHITO-KAI,	
2. ARAKAKI_NEVES KIMAR (WEST COAST GOJU-	
3. CHEN MUTTE (SOUTH SURREY KARATE CLUB	

Referees:			

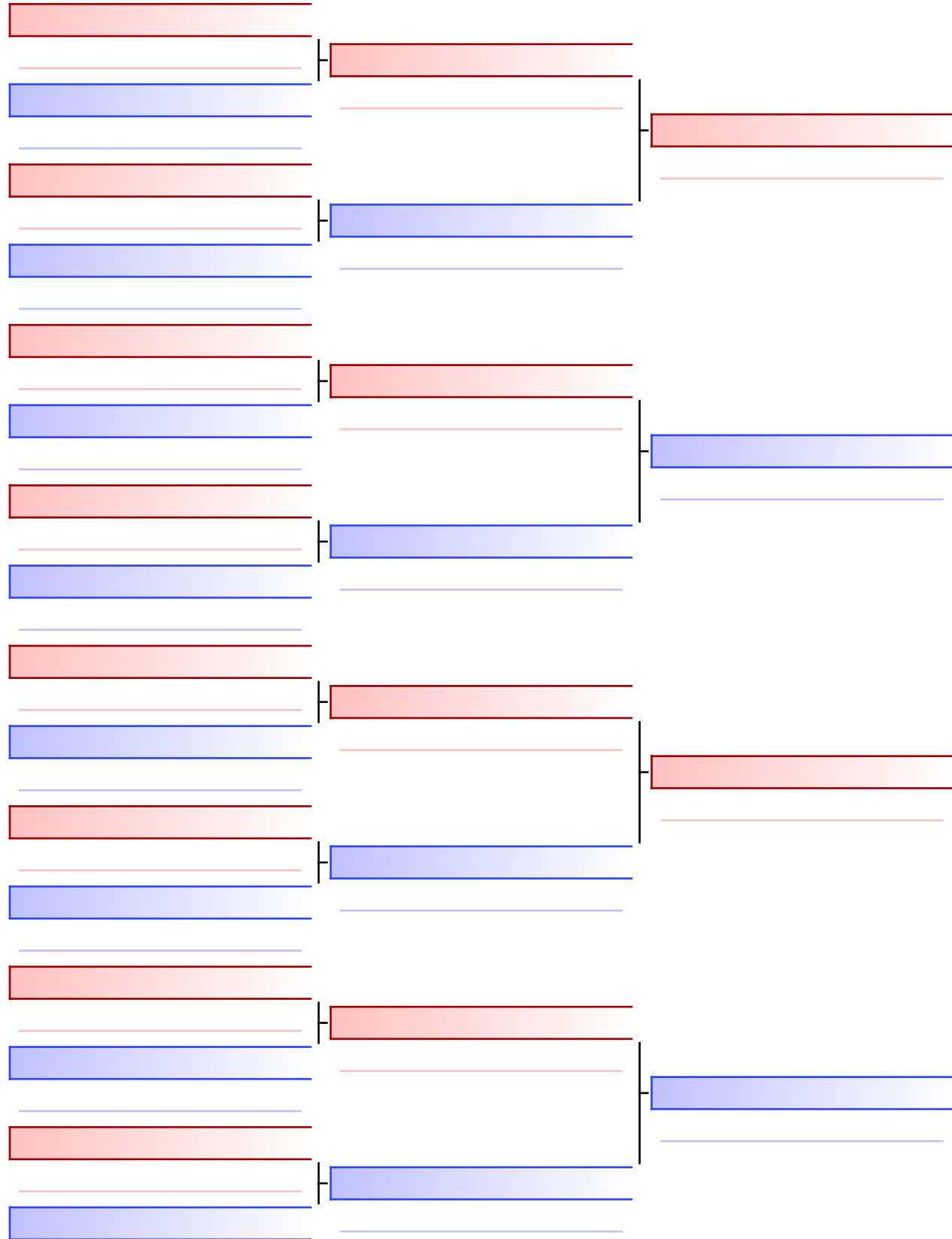

Final

JOSS ROBERT (KIMNIK SHOTOKAN KARATE ACADEMY,CAN)

2

ESPLY JASCHA (POCO KARATE,CAN)

ESPLY JASCHA (POCO KARATE,CAN)

3

1. ESPLY JASCHA (POCO KARATE,CAN)
2. JOSS ROBERT (KIMNIK SHOTOKAN KARATE ACADEMY,CAN)

Referees:			

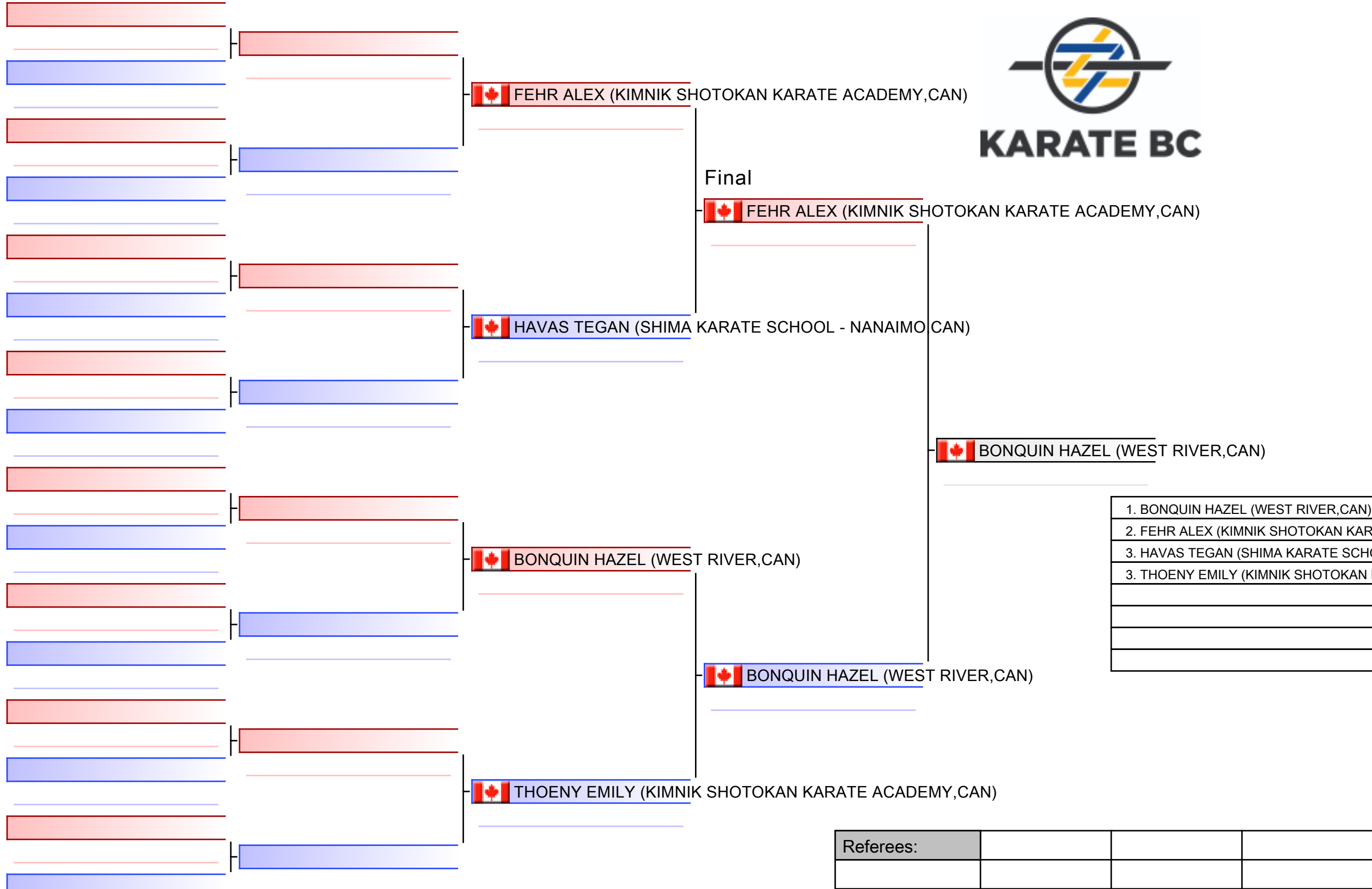

1. BONQUIN HAZEL (WEST RIVER, CAN)
2. FEHR ALEX (KIMNIK SHOTOKAN KARATE ACADEMY, CAN)
3. HAVAS TEGAN (SHIMA KARATE SCHOOL - NANAIMO CAN)
3. THOENY EMILY (KIMNIK SHOTOKAN KARATE ACADEMY, CAN)

Referees:			

RK-5 Girls 10/11 - Kata Novice

2019 Karate BC Provincial Championships

Tatami
5 09:45

Pool
1

(c)sportdata GmbH & Co KG 2000-2019(2019-12-04 00:10) -WKF Approved- v 9.8.6 build 2 License: Karate BC (expire 2020-10-12)

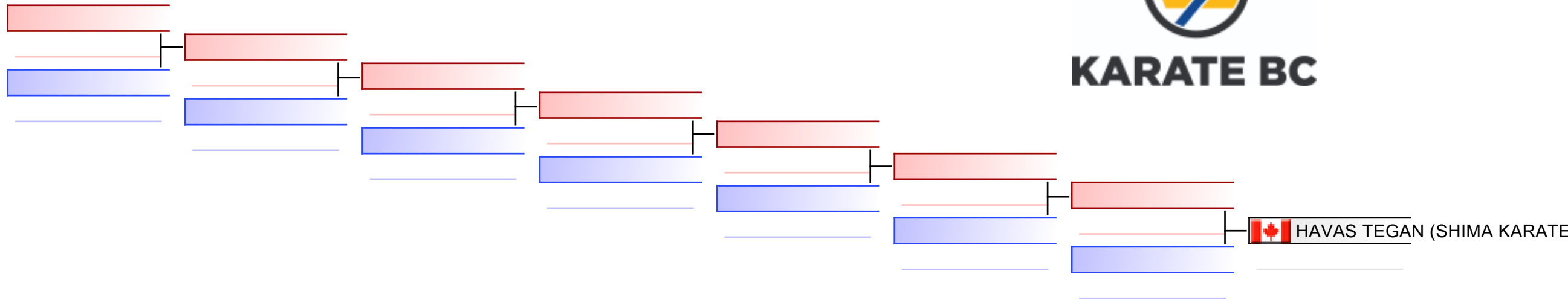

REPECHAGE: (1)

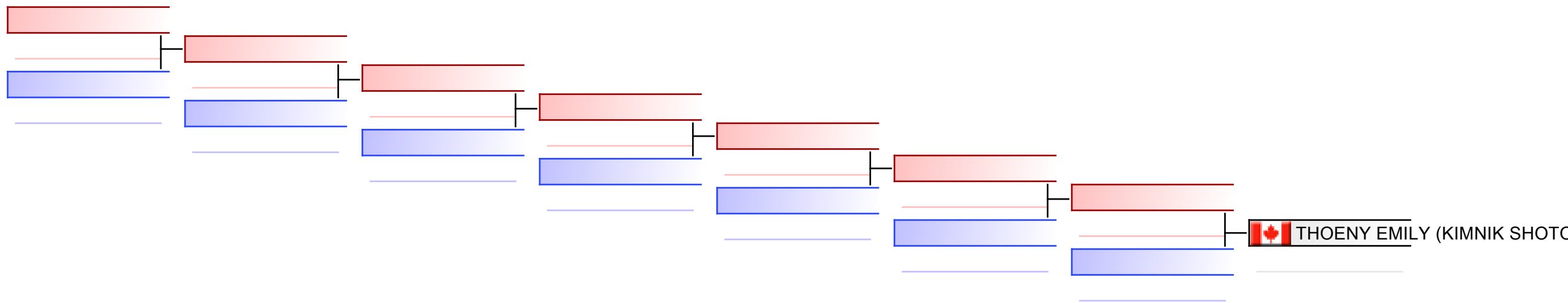

Referees:							
-----------	--	--	--	--	--	--	--

RK-6 Girls 10/11 - Kata Intermediate

2019 Karate BC Provincial Championships, CAN

Tatami
4 10:15

Pool
1/1



KARATE BC

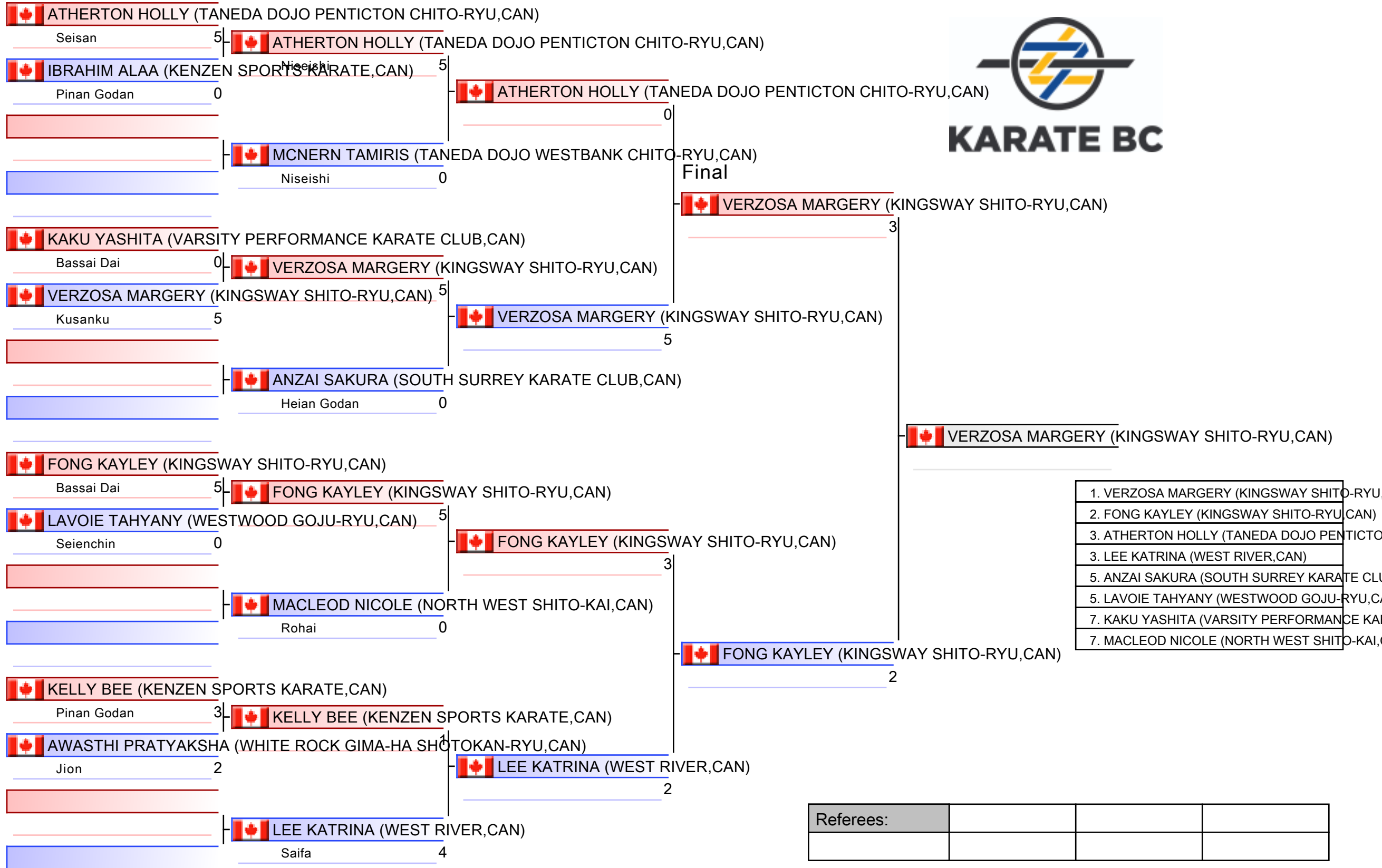

RK-6 Girls 10/11 - Kata Intermediate

2019 Karate BC Provincial Championships

Tatami
4 11:05

Pool
1

(c)sportdata GmbH & Co KG 2000-2019(2019-12-04 00:10) -WKF Approved- v 9.8.6 build 2 License: Karate BC (expire 2020-10-12)

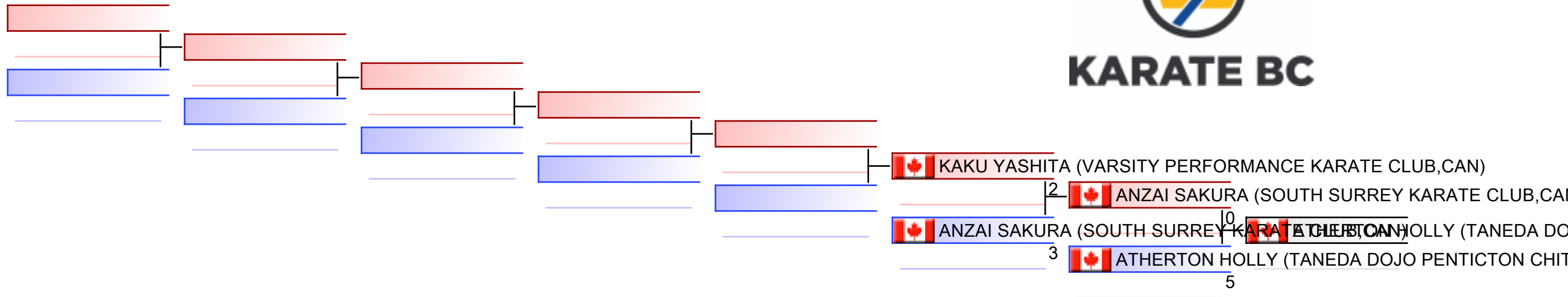

REPECHAGE: (1)

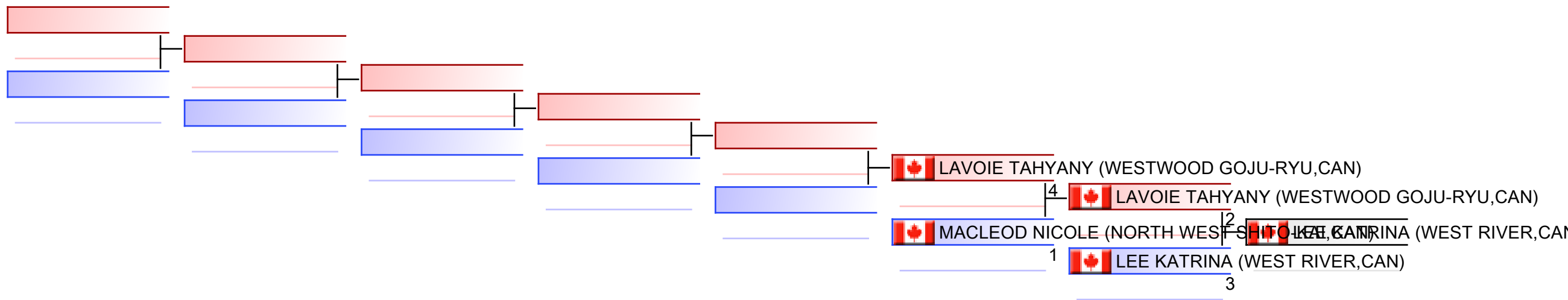









Referees:							
-----------	--	--	--	--	--	--	--

RK-7 Girls 10/11 - Kata Adv/Black - Round Robin (each against each)

2019 Karate BC Provincial Championships, CAN

Tatami
1 11:05

Pool
1/1

- 1  LEE AMANDA (WEST RIVER,CAN)
5 |  LEE AMANDA (WEST RIVER,CAN)
- 2  LO ZOE (THOMPSON KARATE CLUB,CAN)
0
- 3  LEE AMANDA (WEST RIVER,CAN)
2 |  CHAN EMILY (WEST VAN KARATE ACADEMY,CAN)
- 4  CHAN EMILY (WEST VAN KARATE ACADEMY,CAN)
3
- 5  LO ZOE (THOMPSON KARATE CLUB,CAN)
0 |  CHAN EMILY (WEST VAN KARATE ACADEMY,CAN)
- 6  CHAN EMILY (WEST VAN KARATE ACADEMY,CAN)
5



1. CHAN EMILY (WEST VAN KARATE ACADEMY,CAN)
2. LEE AMANDA (WEST RIVER,CAN)
3. LO ZOE (THOMPSON KARATE CLUB,CAN)

Referees:				



KARATE BC

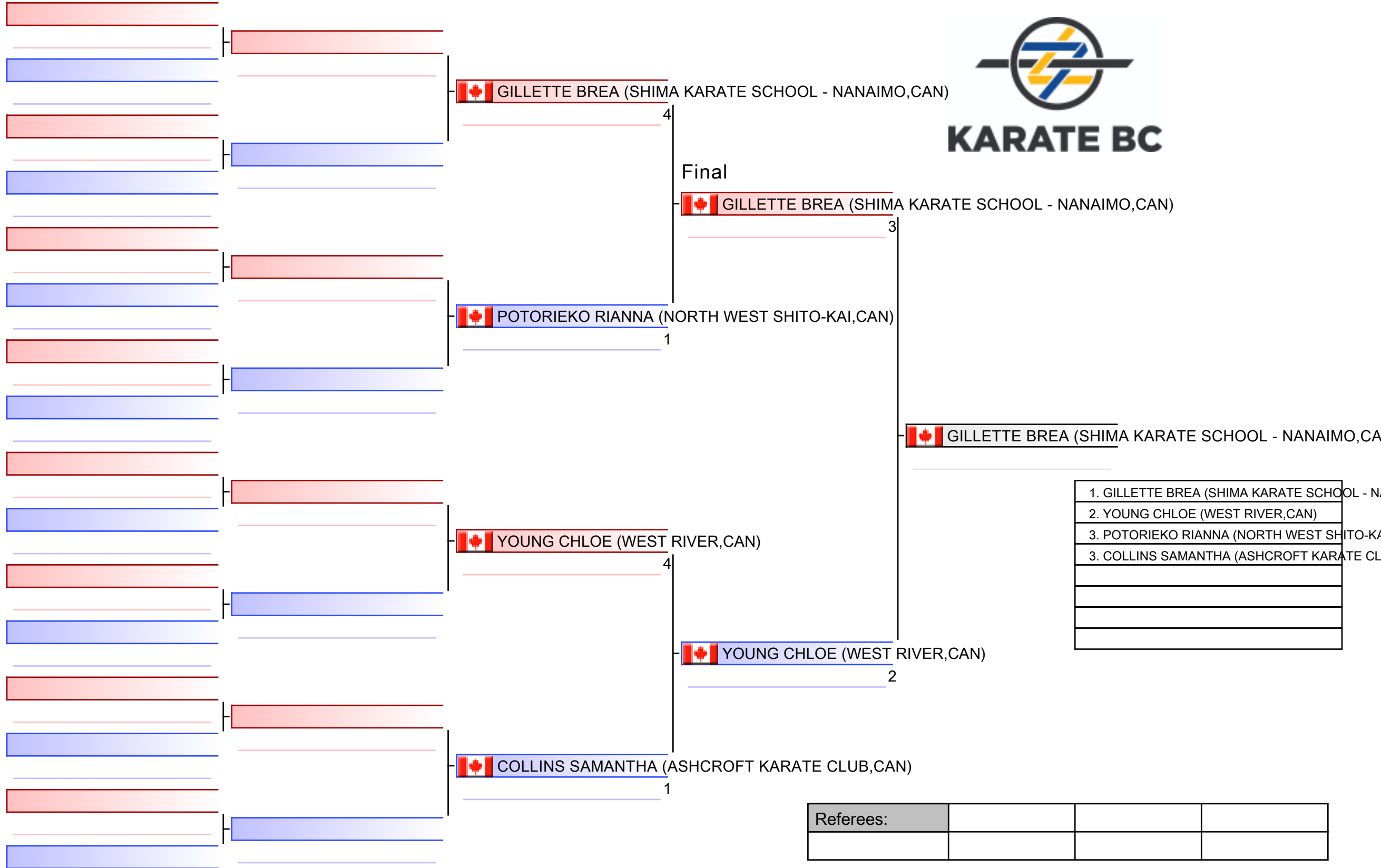

RK-9 Girls 12/13 - Kata Intermediate

2019 Karate BC Provincial Championships

Tatami

Pool
1

(c)sportdata GmbH & Co KG 2000-2019(2019-12-04 00:10) -WKF Approved- v 9.8.6 build 2 License: Karate BC (expire 2020-10-12)

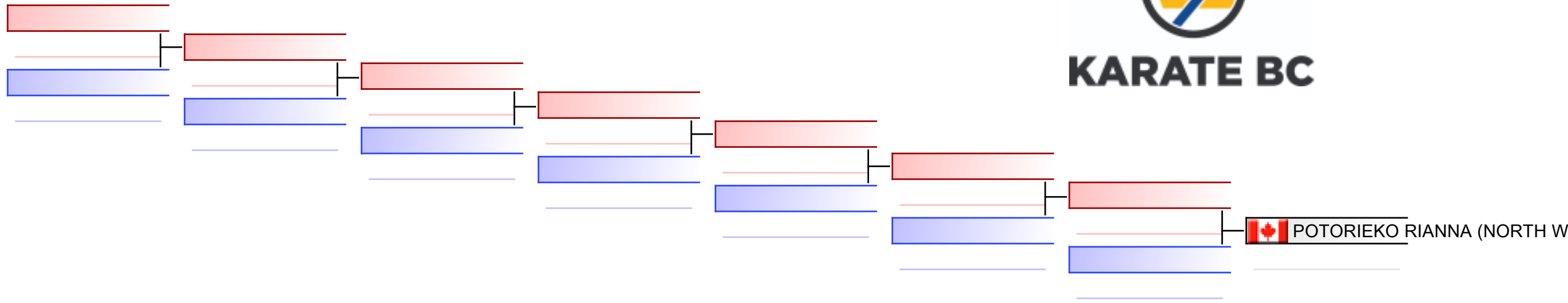

REPECHAGE: (1)

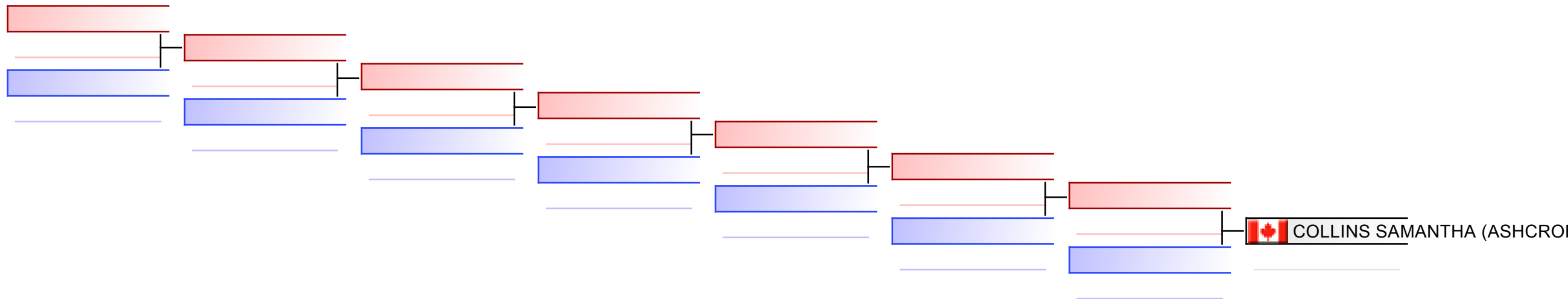

Referees:							
-----------	--	--	--	--	--	--	--

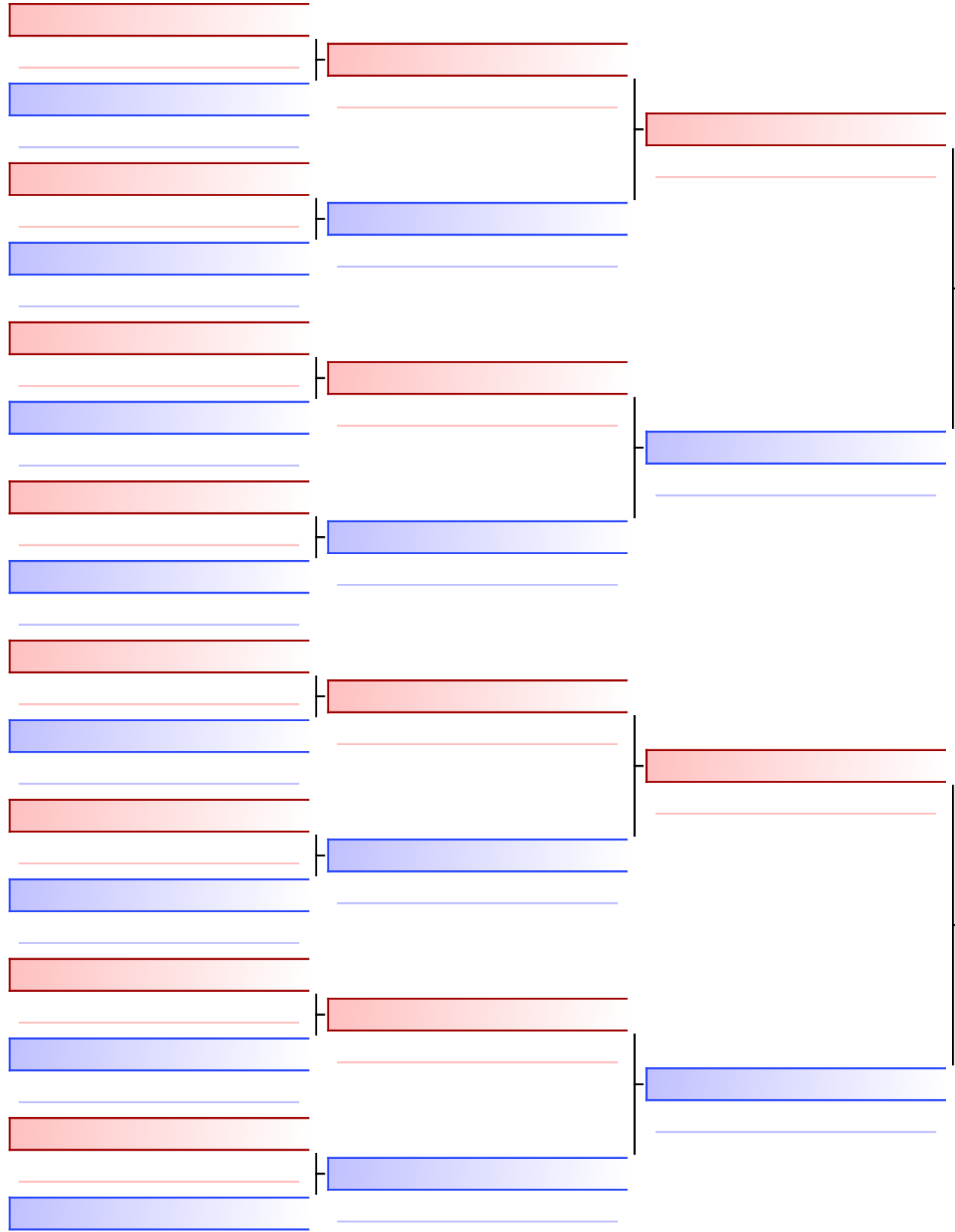

Final

WALSH-SCHERK PHOEBE (ELITE KARATE ACADEMY - SURREY, CAN)

2

SNOW-KIMURA MEI (KINGSWAY SHITO-RYU, CAN)

SNOW-KIMURA MEI (KINGSWAY SHITO-RYU, CAN)

4

1. SNOW-KIMURA MEI (KINGSWAY SHITO-RYU, CAN)
2. WALSH-SCHERK PHOEBE (ELITE KARATE ACADEMY - SURREY, CAN)

Referees:			

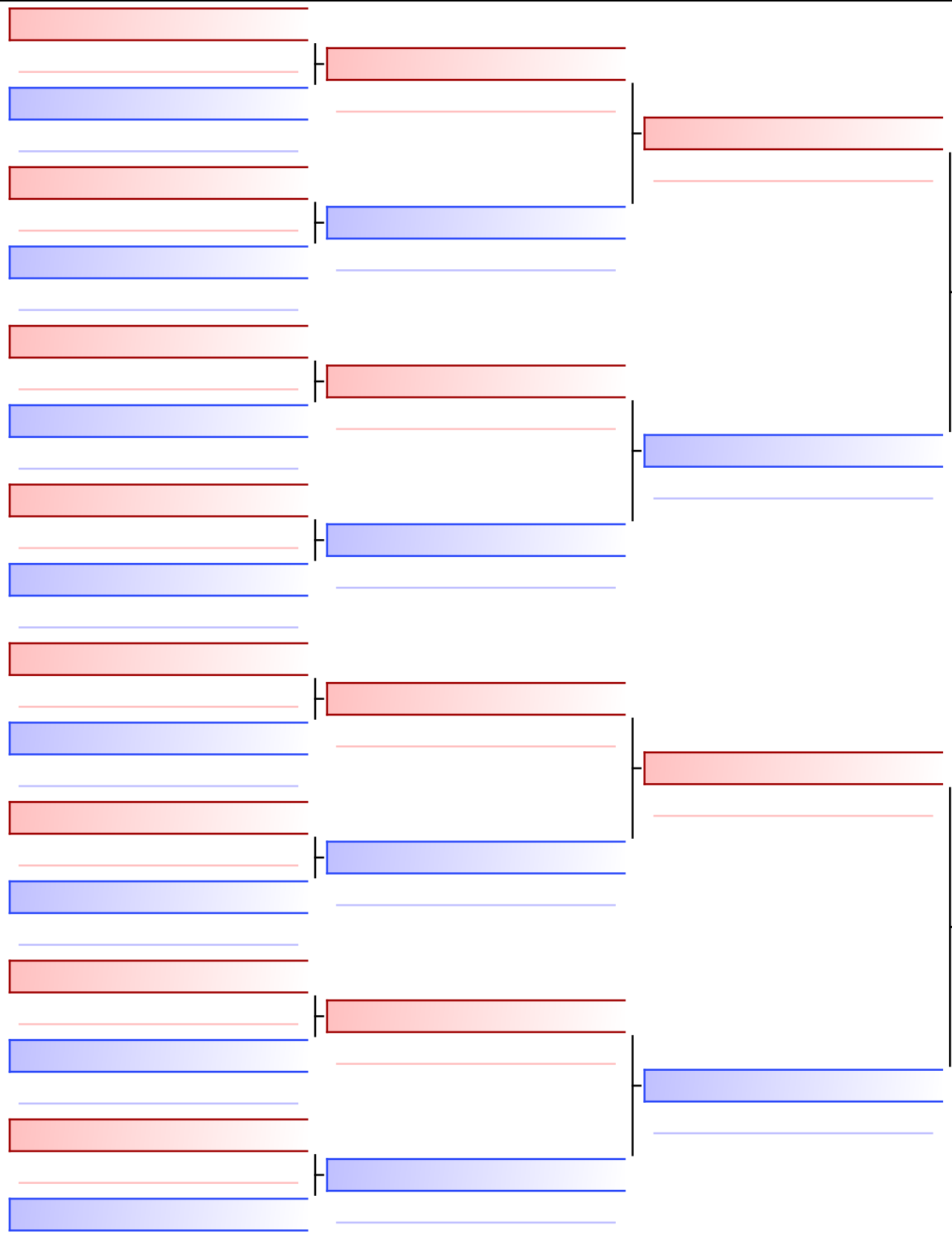

Final

LAU ELISABETH (WEST RIVER,CAN)

LAU ELISABETH (WEST RIVER,CAN)

LEGGOTT LILY (TANEDA DOJO KELOWNA CHITO-RYU,CAN)

1. LAU ELISABETH (WEST RIVER,CAN)
2. LEGGOTT LILY (TANEDA DOJO KELOWNA CHI

Referees:			

RS-13 Girls 14/15 - Kumite Adv/Black - Round Robin (each against each)

2019 Karate BC Provincial Championships, CAN

Tatami
5 14:55

Pool
1/1

- 1  GAO EMILY (KENZEN SPORTS KARATE,CAN) vs  IRELAND CHLOE (KIMNIK SHOTOKAN KARATE ACADEMY,CAN)
- 2  IRELAND CHLOE (KIMNIK SHOTOKAN KARATE ACADEMY,CAN)
- 3  GAO EMILY (KENZEN SPORTS KARATE,CAN) vs  GAO EMILY (KENZEN SPORTS KARATE,CAN)
- 4  BRAUN AUDREY (ARBUTUS CLUB SHITO-RYU INTERNATIONAL KARATE-DO,CAN)
- 5  IRELAND CHLOE (KIMNIK SHOTOKAN KARATE ACADEMY,CAN) vs  IRELAND CHLOE (KIMNIK SHOTOKAN KARATE ACADEMY,CAN)
- 6  BRAUN AUDREY (ARBUTUS CLUB SHITO-RYU INTERNATIONAL KARATE-DO,CAN)



1. IRELAND CHLOE (KIMNIK SHOTOKAN KARATE ACADEMY,CAN)
2. GAO EMILY (KENZEN SPORTS KARATE,CAN)
3. BRAUN AUDREY (ARBUTUS CLUB SHITO-RYU INTERNATIONAL KARATE-DO,CAN)

Referees:			

RS-1 Girls 7 & Under - Kumite All belts

2019 Karate BC Provincial Championships, CAN

Tatami
2 13:40

Pool
1/1

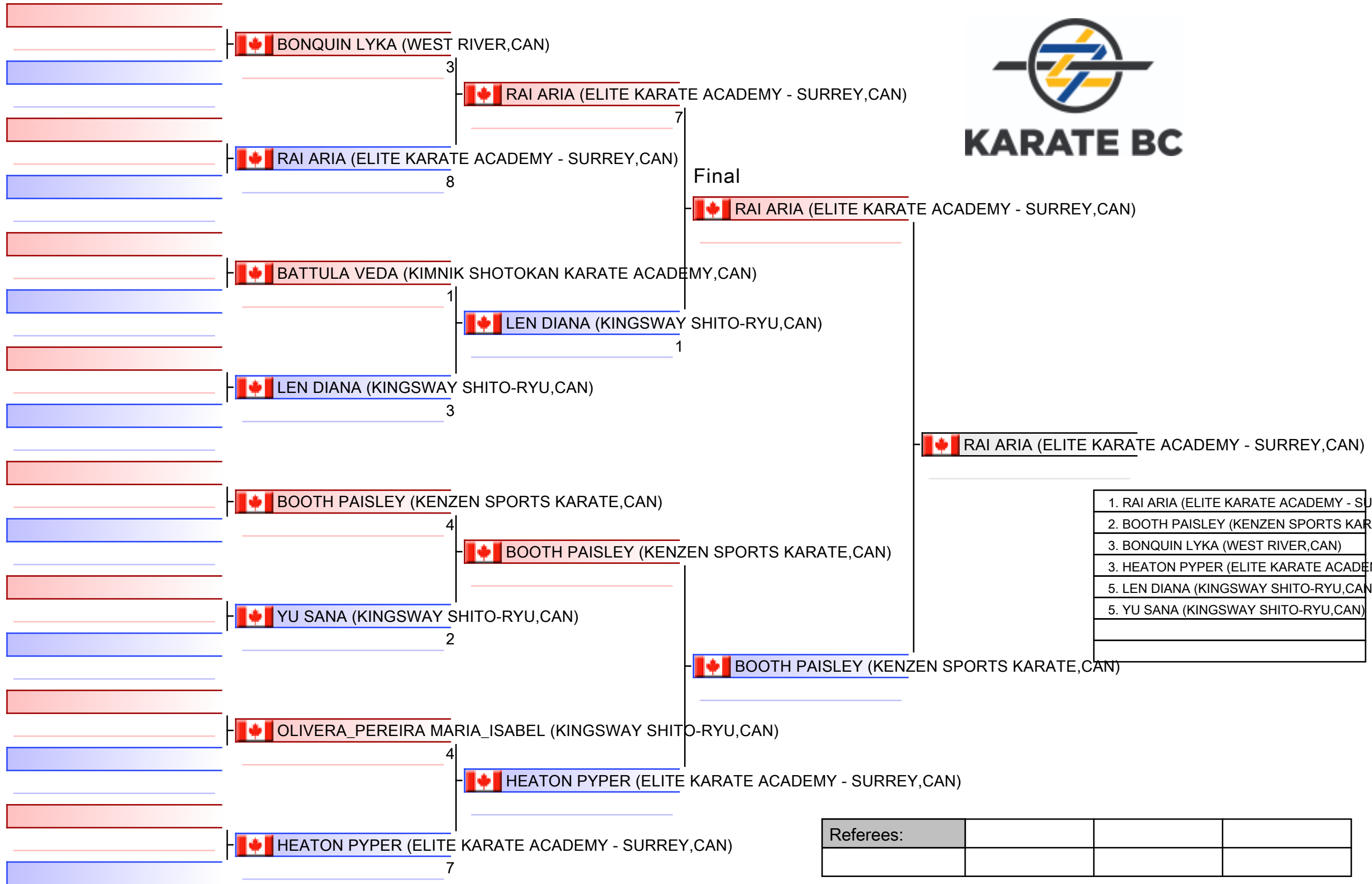

RS-1 Girls 7 & Under - Kumite All belts

2019 Karate BC Provincial Championships

Tatami
2 14:05

Pool
1

(c)sportdata GmbH & Co KG 2000-2019(2019-12-04 00:10) -WKF Approved- v 9.8.6 build 2 License: Karate BC (expire 2020-10-12)

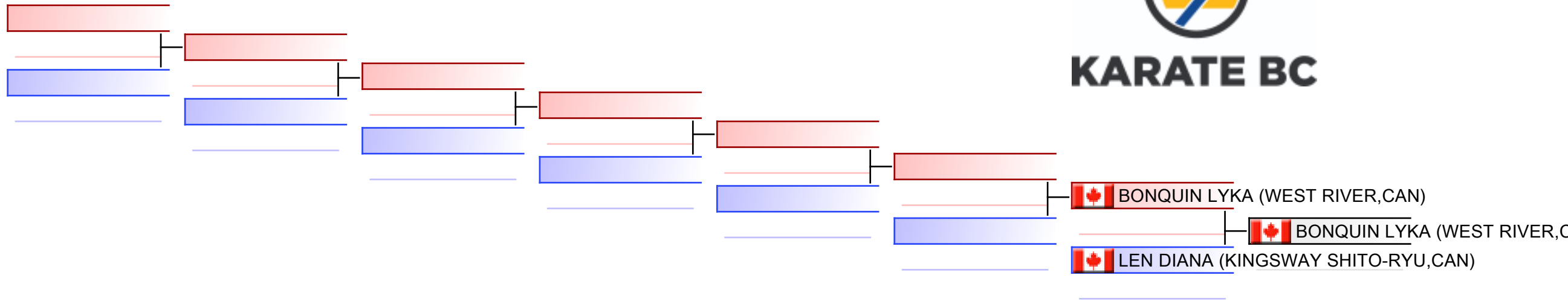

REPECHAGE: (1)

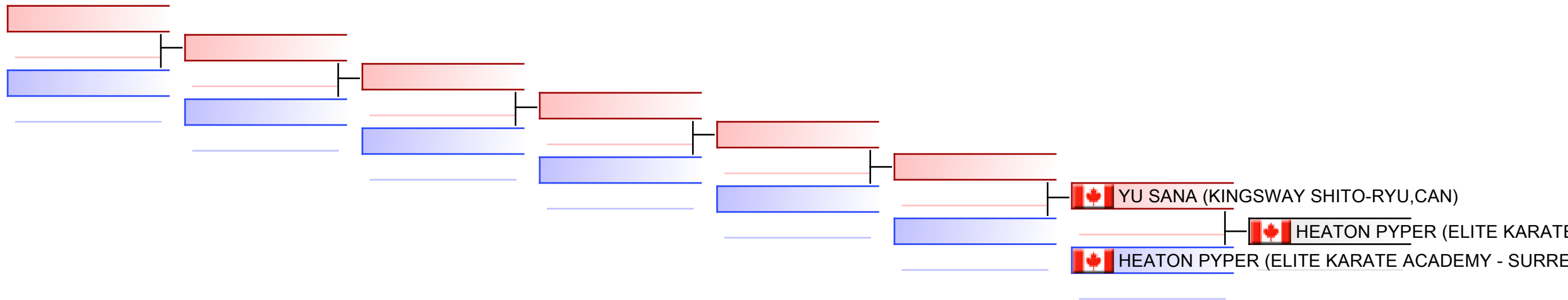

Referees:							
-----------	--	--	--	--	--	--	--

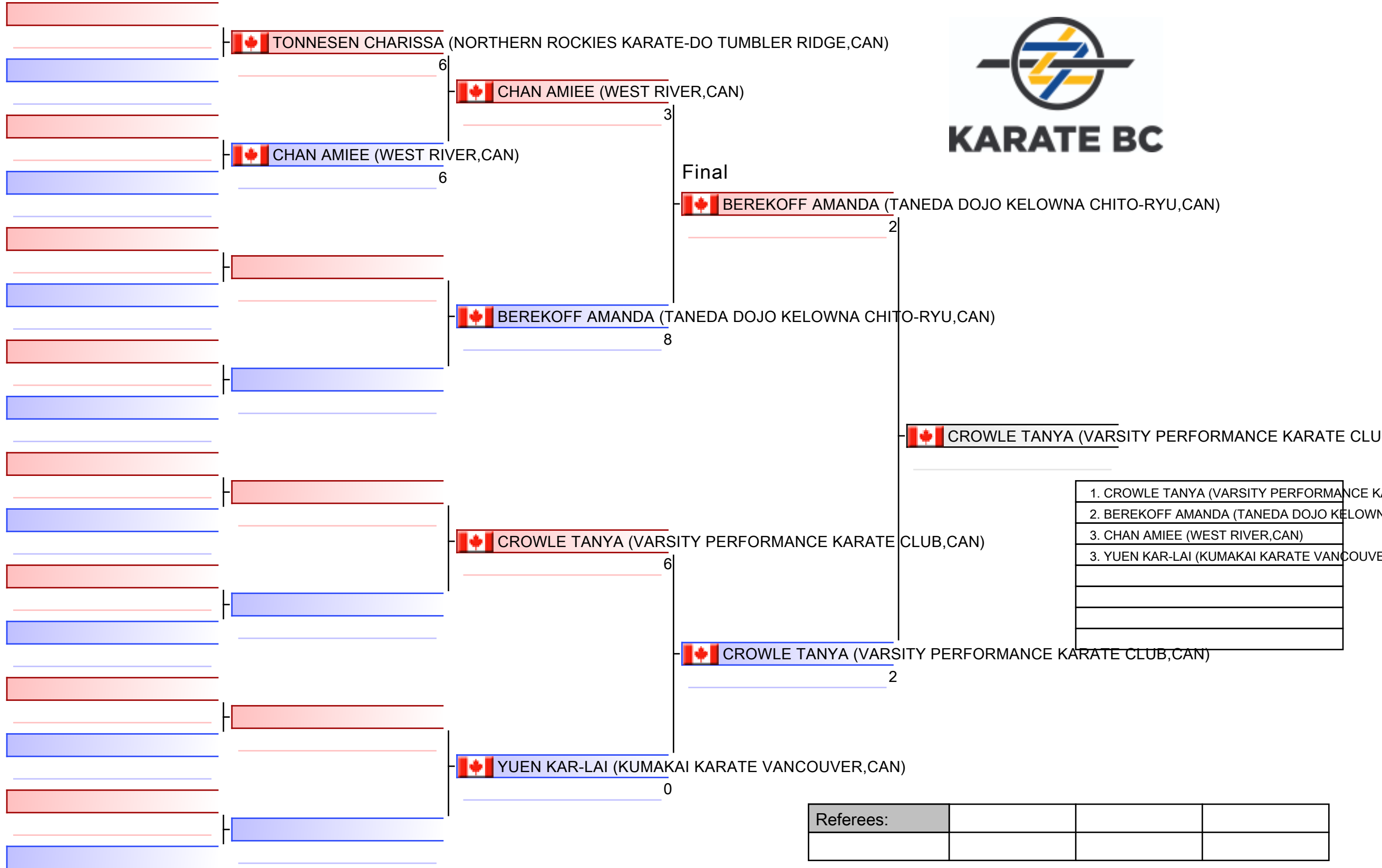

RS-22 Masters Womens Kumite Nov to Adv

2019 Karate BC Provincial Championships

Tatami
3 15:40

Pool
1

(c)sportdata GmbH & Co KG 2000-2019(2019-12-04 00:10) -WKF Approved- v 9.8.6 build 2 License: Karate BC (expire 2020-10-12)

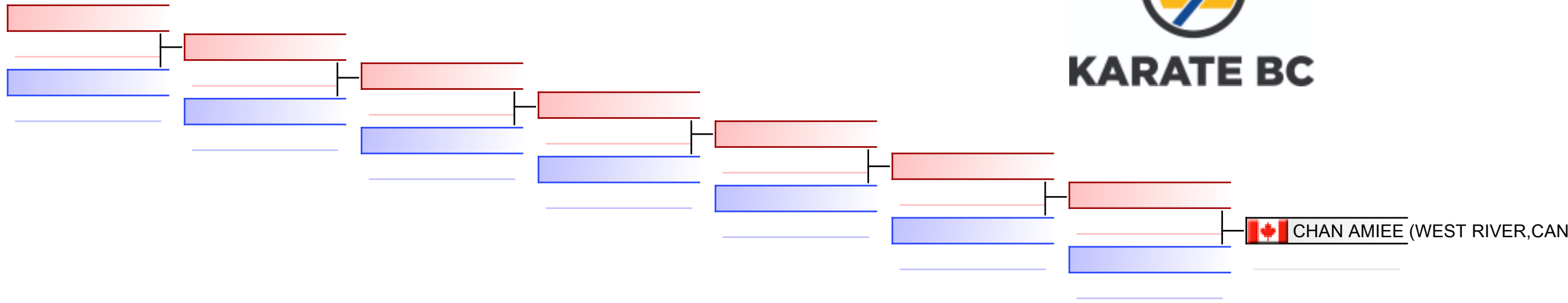

REPECHAGE: (1)

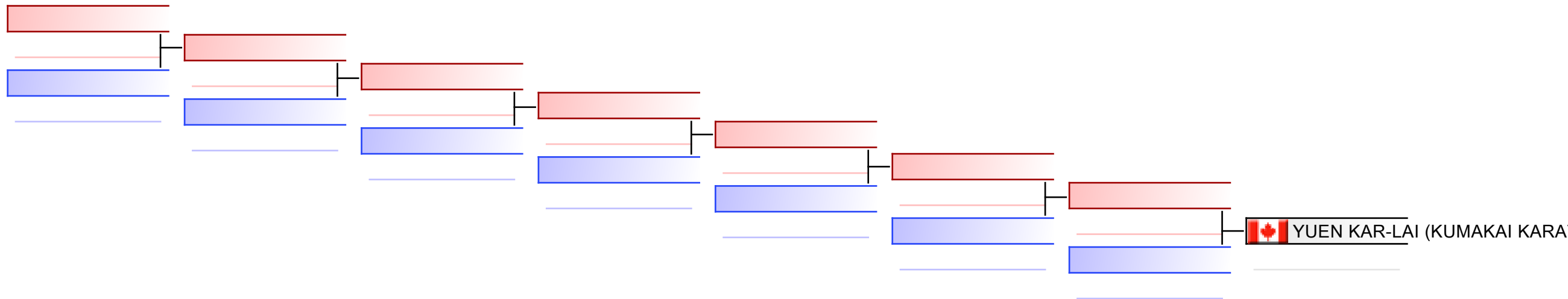

Referees:							
-----------	--	--	--	--	--	--	--

RS-25 Boys 7 & Under - All Belts Kumite

2019 Karate BC Provincial Championships, CAN

Tatami
3 12:20

Pool
1/1

 HENDERSON CLIFFORD_JAMES (NORTHERN ROCKIES KARATE-DO PRINCE GEORGE,CAN)

0  DECOLA ROCCO (BURNABY KARATE ACADEMY,CAN)

 DECOLA ROCCO (BURNABY KARATE ACADEMY,CAN)

6  DELA_CRUZ MIKEY (ELITE KARATE ACADEMY - SURREY,CAN)

3

 DELA_CRUZ MIKEY (ELITE KARATE ACADEMY - SURREY,CAN)

3

 CRUZ JACOB (KIMNIK SHOTOKAN KARATE ACADEMY,CAN)

4  CRUZ JACOB (KIMNIK SHOTOKAN KARATE ACADEMY,CAN)

 DE_LA_VALLEE_POUSSIN DANIEL (TIGERS EYE KARATE-DO NORTH SHORE,CAN)

1  CRUZ JACOB (KIMNIK SHOTOKAN KARATE ACADEMY,CAN)

6

 FONG RYDER (KINGSWAY SHITO-RYU,CAN)

4

 KOHLI PARSA (KIMNIK SHOTOKAN KARATE ACADEMY,CAN)

3  KOHLI PARSA (KIMNIK SHOTOKAN KARATE ACADEMY,CAN)

 CHOI EESAM (WEST COAST GOJU-KAI,CAN)

0  KOHLI PARSA (KIMNIK SHOTOKAN KARATE ACADEMY,CAN)

2

 SIDHU JADEN (ELITE KARATE ACADEMY - SURREY,CAN)

0

 KUMAR NOAH (ELITE KARATE ACADEMY - SURREY,CAN)

0

 NGUYEN ETHAN (KINGSWAY SHITO-RYU,CAN)

0

 KUMAR NOAH (ELITE KARATE ACADEMY - SURREY,CAN)

3

 KUMAR NOAH (ELITE KARATE ACADEMY - SURREY,CAN)

4



Final

 CRUZ JACOB (KIMNIK SHOTOKAN KARATE ACADEMY,CAN)

6

 CRUZ JACOB (KIMNIK SHOTOKAN KARATE ACADEMY,CAN)

- | |
|---|
| 1. CRUZ JACOB (KIMNIK SHOTOKAN KARATE AC |
| 2. KUMAR NOAH (ELITE KARATE ACADEMY - SUR |
| 3. NGUYEN ETHAN (KINGSWAY SHITO-RYU,CAN) |
| 3. DELA_CRUZ MIKEY (ELITE KARATE ACADEMY |
| 5. KOHLI PARSA (KIMNIK SHOTOKAN KARATE AC |
| 5. FONG RYDER (KINGSWAY SHITO-RYU,CAN) |
| 7. DE_LA_VALLEE_POUSSIN DANIEL (TIGERS EY |

Referees:			

RS-25 Boys 7 & Under - All Belts Kumite

2019 Karate BC Provincial Championships

Tatami
3 12:50

Pool
1

(c)sportdata GmbH & Co KG 2000-2019(2019-12-04 00:10) -WKF Approved- v 9.8.6 build 2 License: Karate BC (expire 2020-10-12)

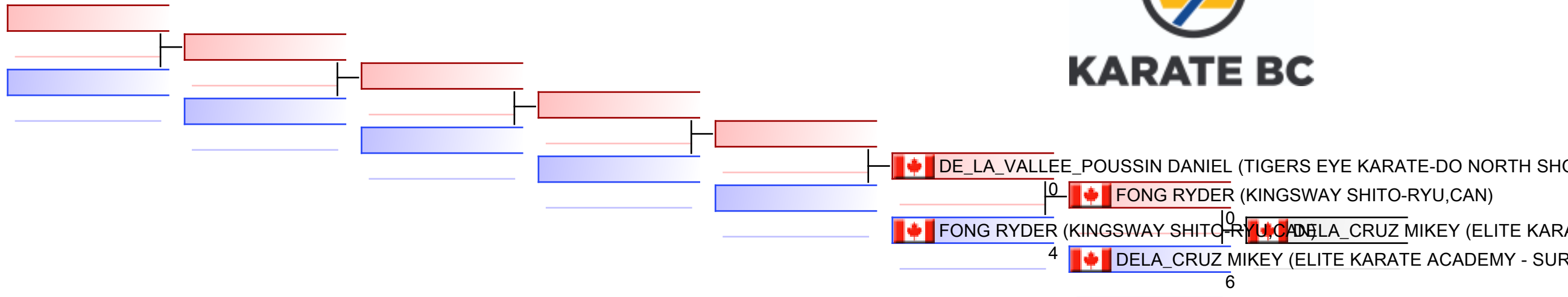

REPECHAGE: (1)

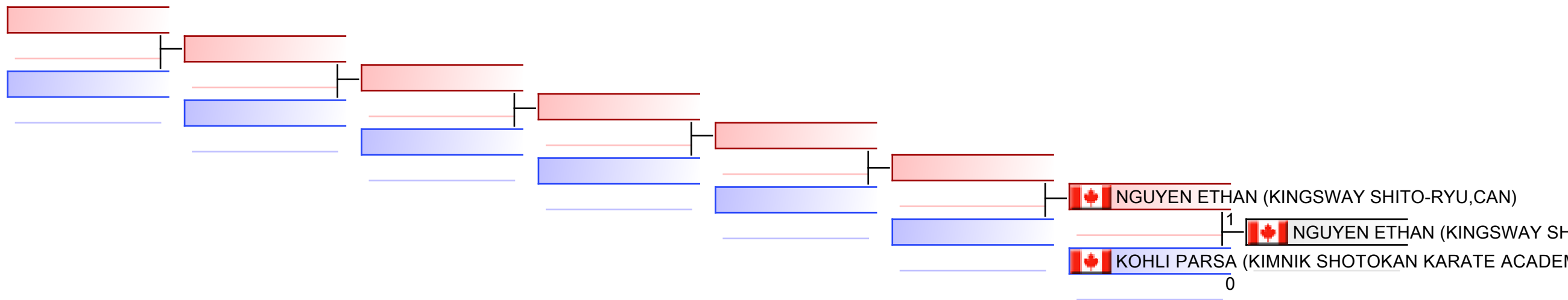

Referees:							
-----------	--	--	--	--	--	--	--

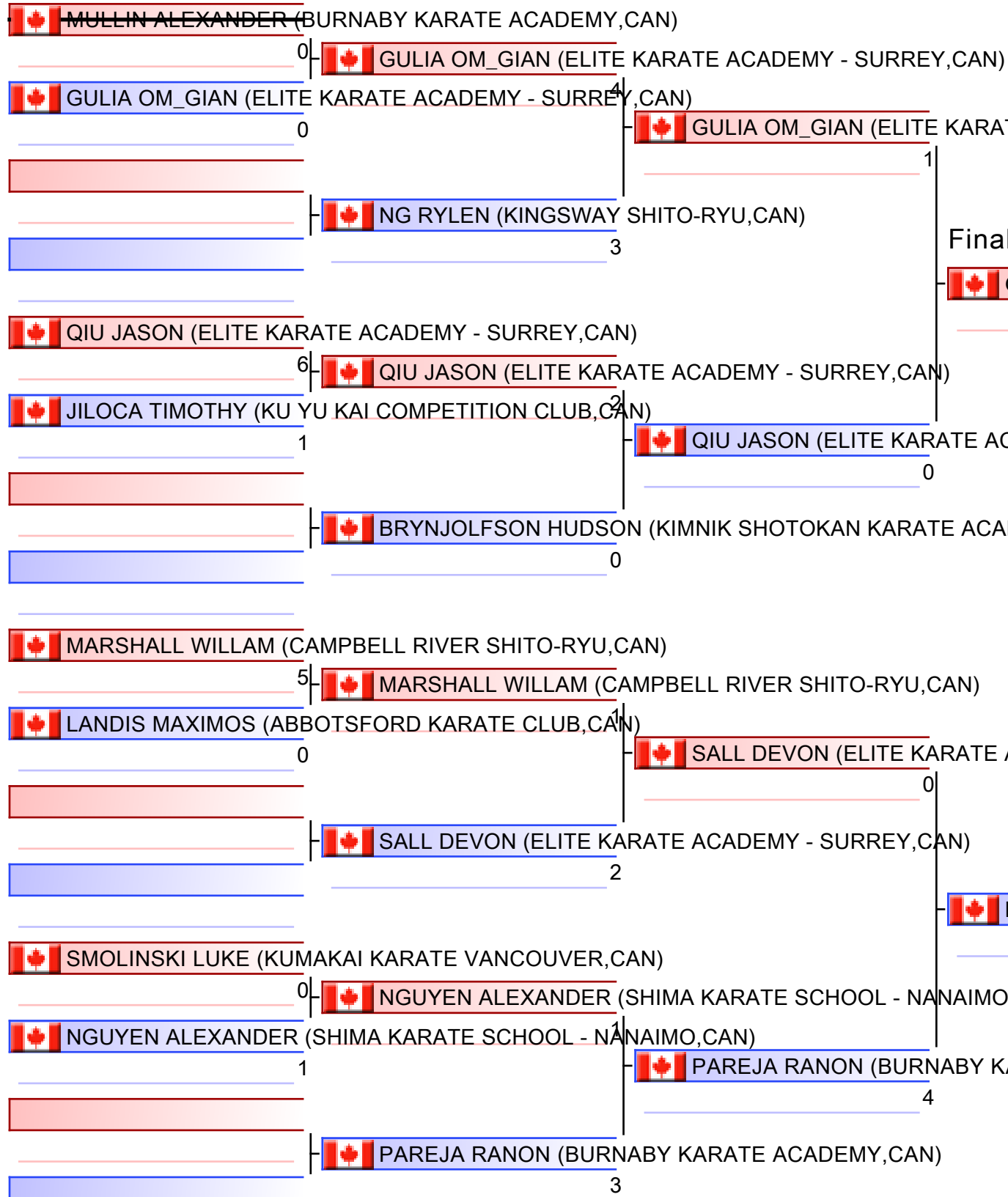

- | |
|--|
| 1. PAREJA RANON (BURNABY KARATE ACADEMY, CAN) |
| 2. GULIA OM_GIAN (ELITE KARATE ACADEMY - SURREY, CAN) |
| 3. QIU JASON (ELITE KARATE ACADEMY - SURREY, CAN) |
| 3. SALL DEVON (ELITE KARATE ACADEMY - SURREY, CAN) |
| 5. NG RYLEN (KINGSWAY SHITO-RYU, CAN) |
| 5. NGUYEN ALEXANDER (SHIMA KARATE SCHOOL - NANAIMO, CAN) |
| |
| |

Referees:			

RS-26 Boys 8/9 - Kumite Novice

2019 Karate BC Provincial Championships

(c)sportdata GmbH & Co KG 2000-2019(2019-12-04 00:10) -WKF Approved- v 9.8.6 build 2 License: Karate BC (expire 2020-10-12)

Tatami
4 12:55

Pool
1

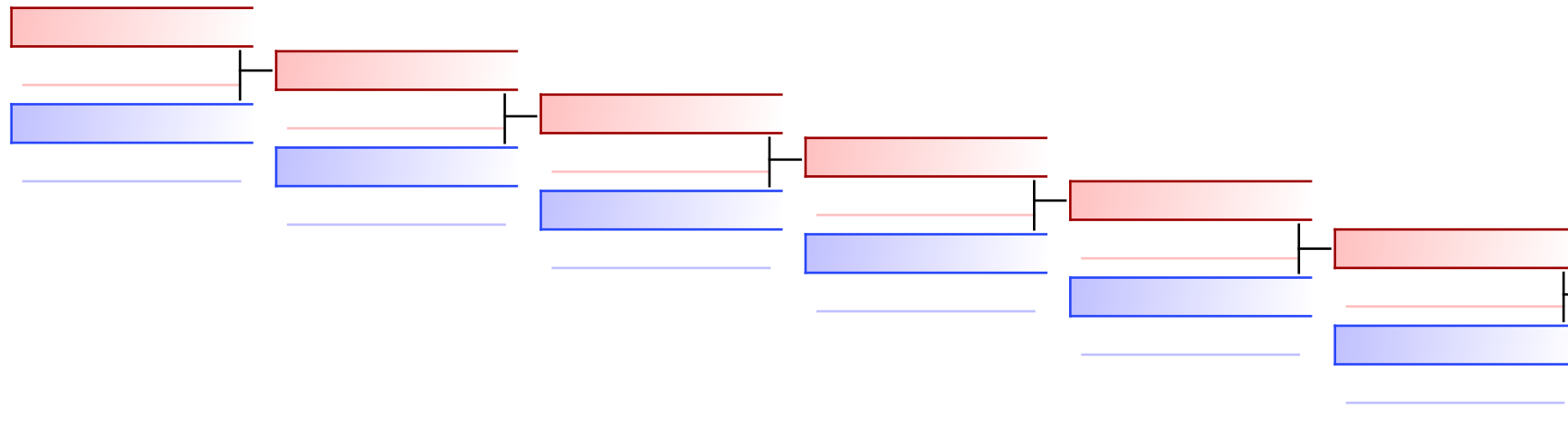

NG RYLEN (KINGSWAY SHITO-RYU,CAN)

QIU JASON (ELITE KARATE ACADEMY - SURREY,CA)

QIU JASON (ELITE KARATE ACADEMY - SURREY,CA)

1
6

REPECHAGE: (1)

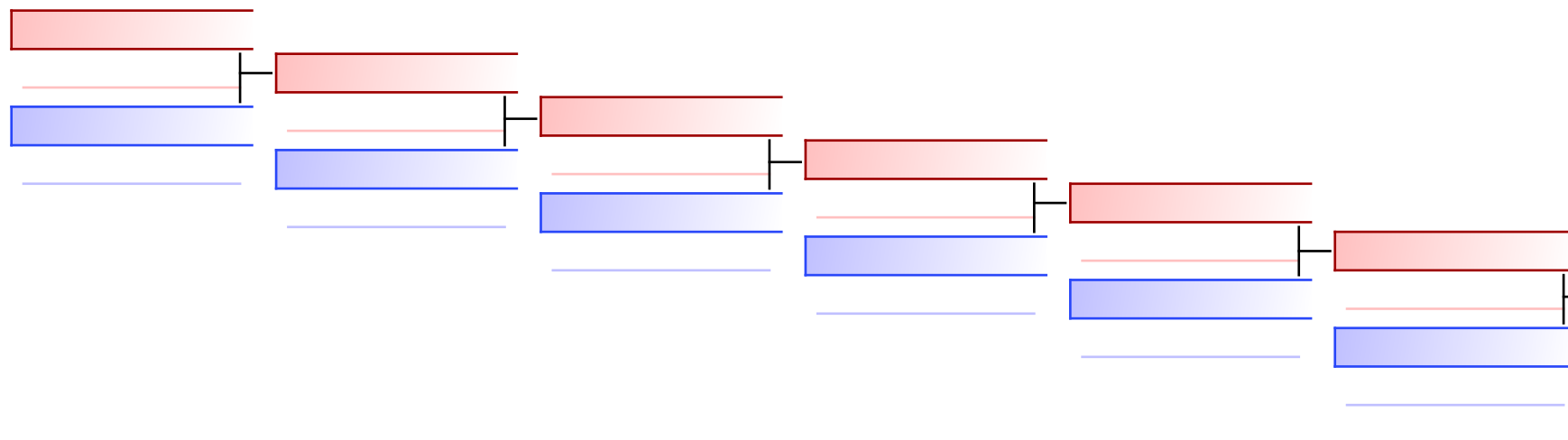

NGUYEN ALEXANDER (SHIMA KARATE SCHOOL - NA)

SALL DEVON (ELITE KARATE ACADEMY - SURREY,CA)

SALL DEVON (ELITE KARATE ACADEMY - SURREY,CA)

1
4

Referees:							
-----------	--	--	--	--	--	--	--

RS-27 Split 1 Boys 9 - Kumite Intermediate

2019 Karate BC Provincial Championships, CAN

Tatami
1 13:50

Pool
1/1



KARATE BC

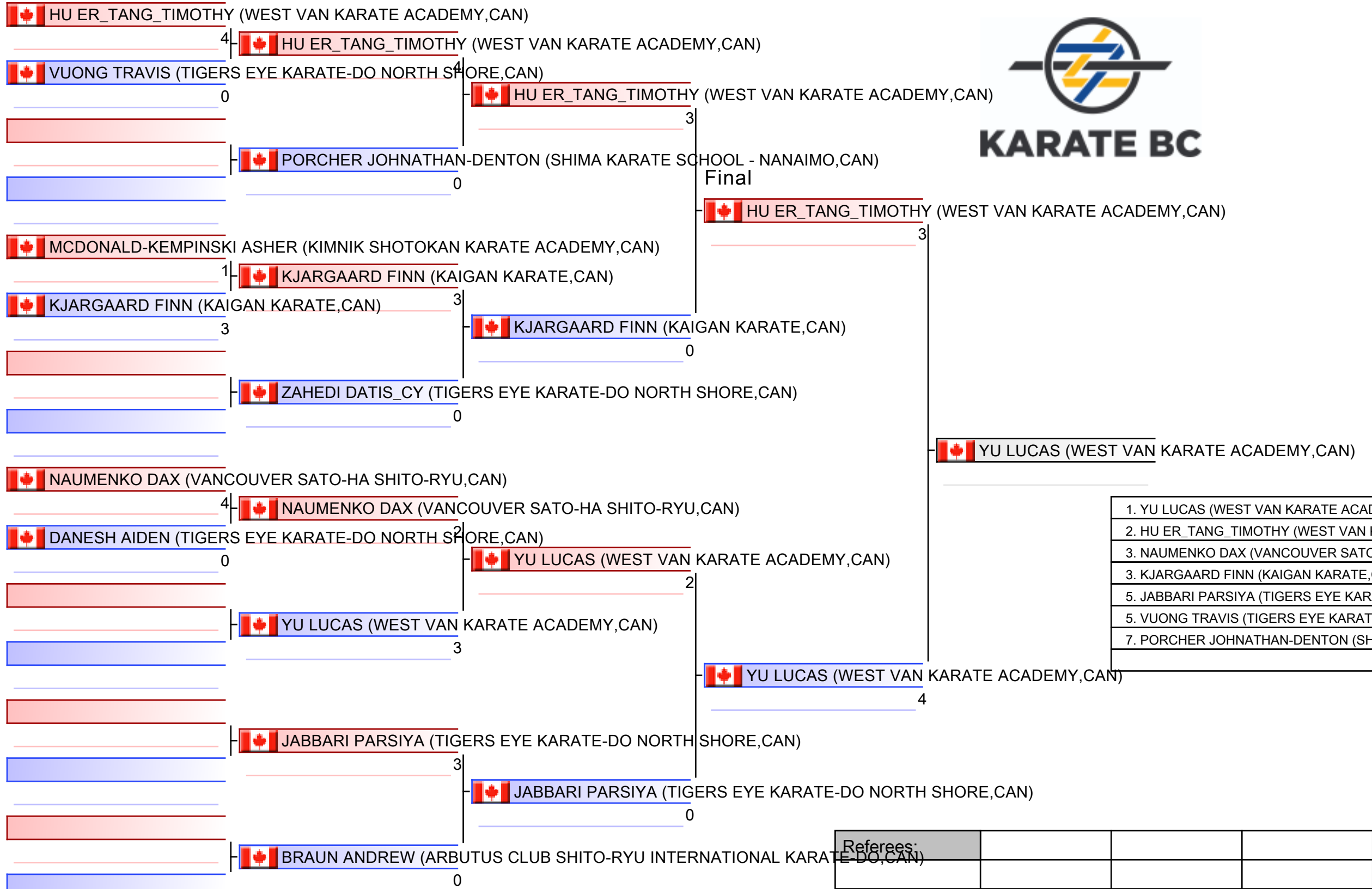

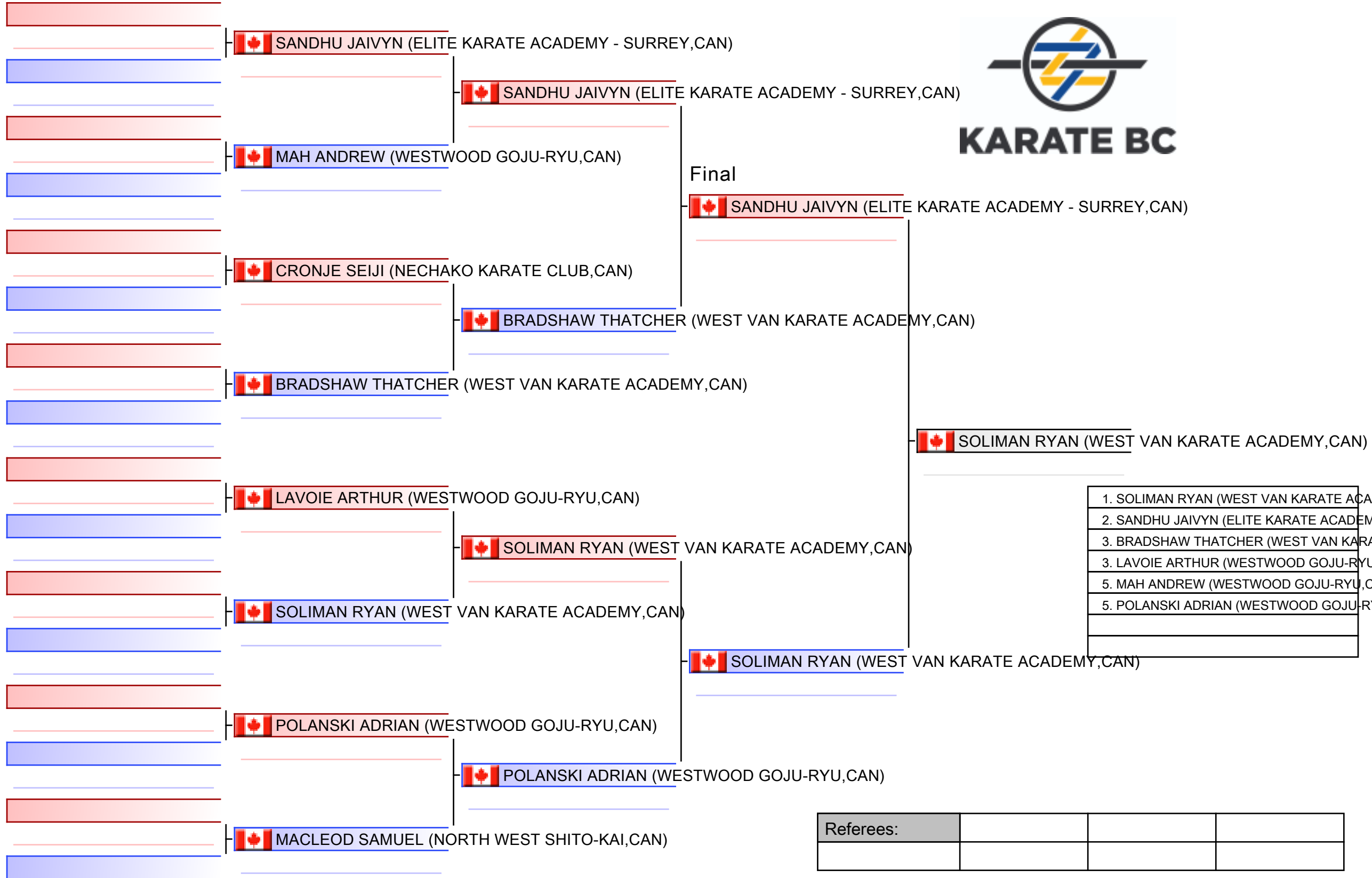

RS-27 Split 2 Boys 8 - Kumite Intermediate

2019 Karate BC Provincial Championships

Tatami
2 14:40

Pool
1

(c)sportdata GmbH & Co KG 2000-2019(2019-12-04 00:10) -WKF Approved- v 9.8.6 build 2 License: Karate BC (expire 2020-10-12)

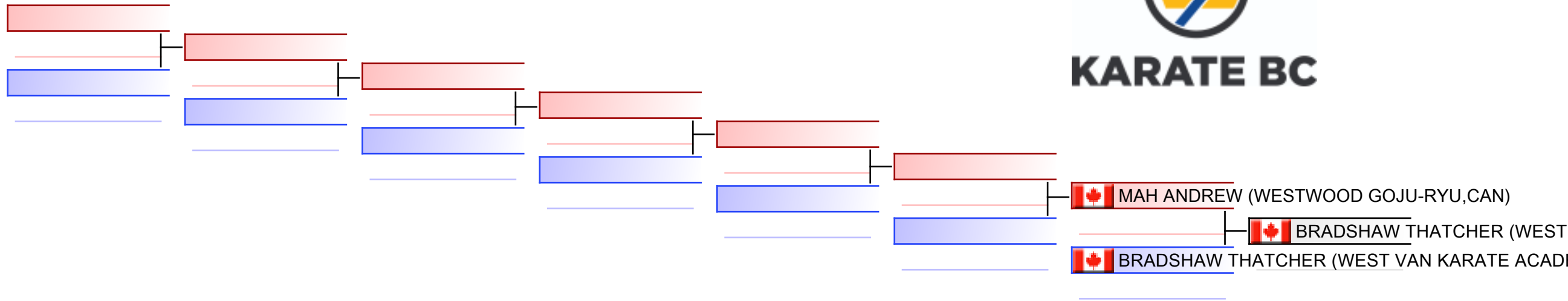

REPECHAGE: (1)

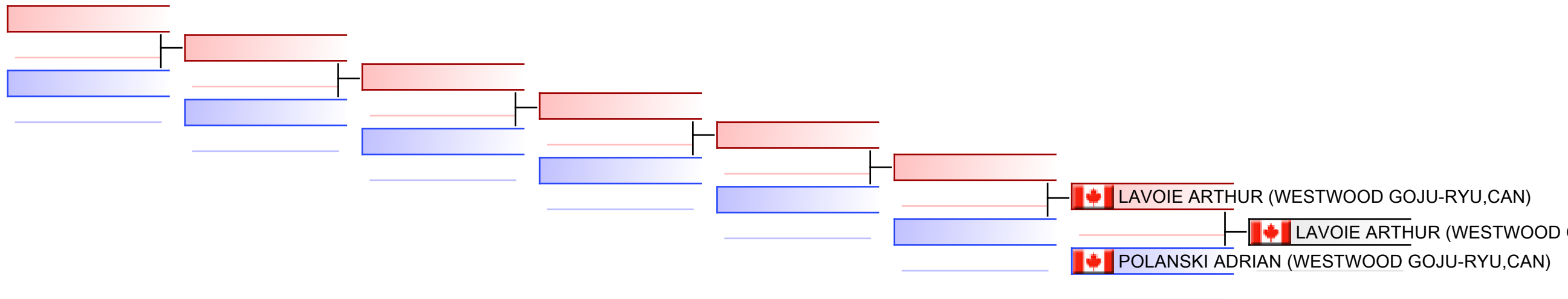

Referees:							
-----------	--	--	--	--	--	--	--

RS-28 Boys 8/9 - Kumite Adv/Black - Round Robin (each against each)

2019 Karate BC Provincial Championships, CAN

Tatami
2 14:55

Pool
1/1

- 1  BOOTH EWAN (KENZEN SPORTS KARATE,CAN)
|  BRAICH ARMAAN_SINGH (ELITE KARATE ACADEMY - SURREY,CAN)
- 2  BRAICH ARMAAN_SINGH (ELITE KARATE ACADEMY - SURREY,CAN)
- 3  BOOTH EWAN (KENZEN SPORTS KARATE,CAN)
|  LESTER-COE QUINN (WEST VAN KARATE ACADEMY,CAN)
- 4  LESTER-COE QUINN (WEST VAN KARATE ACADEMY,CAN)
- 5  BRAICH ARMAAN_SINGH (ELITE KARATE ACADEMY - SURREY,CAN)
|  LESTER-COE QUINN (WEST VAN KARATE ACADEMY,CAN)
- 6  LESTER-COE QUINN (WEST VAN KARATE ACADEMY,CAN)



1. LESTER-COE QUINN (WEST VAN KARATE ACADEMY,CAN)
2. BRAICH ARMAAN_SINGH (ELITE KARATE ACADEMY - SURREY,CAN)
3. BOOTH EWAN (KENZEN SPORTS KARATE,CAN)

Referees:				

 WOROSHELO BRAYDEN (NORTHERN ROCKIES KARATE-DO PRINCE GEORGE,CAN)

6  WOROSHELO BRAYDEN (NORTHERN ROCKIES KARATE-DO PRINCE GEORGE,CAN)

 SALL NATHAN (ELITE KARATE ACADEMY - SURREY,CAN)

2  WOROSHELO BRAYDEN (NORTHERN ROCKIES KARATE-DO PRINCE GEORGE,CAN)

 CATHRINE DAMION (SHIMA KARATE SCHOOL - NANAIMO,CAN)

0

Final

 WOROSHELO BRAYDEN (NORTHERN ROCKIES KARATE-DO PRINCE GEORGE,CAN)

 KHELA KEVIN_SINGH (ELITE KARATE ACADEMY - SURREY,CAN)

1

 HODUT ALEXANDRU (BURNABY KARATE ACADEMY,CAN)

 HODUT ALEXANDRU (BURNABY KARATE ACADEMY,CAN)

6

 WALIA MANVIR (ELITE KARATE ACADEMY - SURREY,CAN)

0

 WALIA MANVIR (ELITE KARATE ACADEMY - SURREY,CAN)

 WONG JORDAN (BRIGHT MARTIAL ARTS & FITNESS,CAN)

0

 MCCARRON OSCAR (NORTHERN ROCKIES KARATE-DO PRINCE GEORGE,CAN)

 MCCARRON OSCAR (NORTHERN ROCKIES KARATE-DO PRINCE GEORGE,CAN)

2

 MCCARRON OSCAR (NORTHERN ROCKIES KARATE-DO PRINCE GEORGE,CAN)

 QIU JERRY (ELITE KARATE ACADEMY - SURREY,CAN)

1

 WOROSHELO BRAYDEN (NORTHERN ROCKIES KARATE-DO PRINCE GEORGE,CAN)

- | |
|---|
| 1. WOROSHELO BRAYDEN (NORTHERN ROCKIES KARATE-DO PRINCE GEORGE,CAN) |
| 2. MCCARRON OSCAR (NORTHERN ROCKIES KARATE-DO PRINCE GEORGE,CAN) |
| 3. QIU JERRY (ELITE KARATE ACADEMY - SURREY,CAN) |
| 3. HODUT ALEXANDRU (BURNABY KARATE ACADEMY,CAN) |
| 5. WALIA MANVIR (ELITE KARATE ACADEMY - SURREY,CAN) |
| 5. CATHRINE DAMION (SHIMA KARATE SCHOOL - NANAIMO,CAN) |
| 7. SALL NATHAN (ELITE KARATE ACADEMY - SURREY,CAN) |



KARATE BC

Referees:			

RS-29 Boys 10/11 - Kumite Novice

2019 Karate BC Provincial Championships

Tatami
5 13:25

Pool
1

(c)sportdata GmbH & Co KG 2000-2019(2019-12-04 00:10) -WKF Approved- v 9.8.6 build 2 License: Karate BC (expire 2020-10-12)

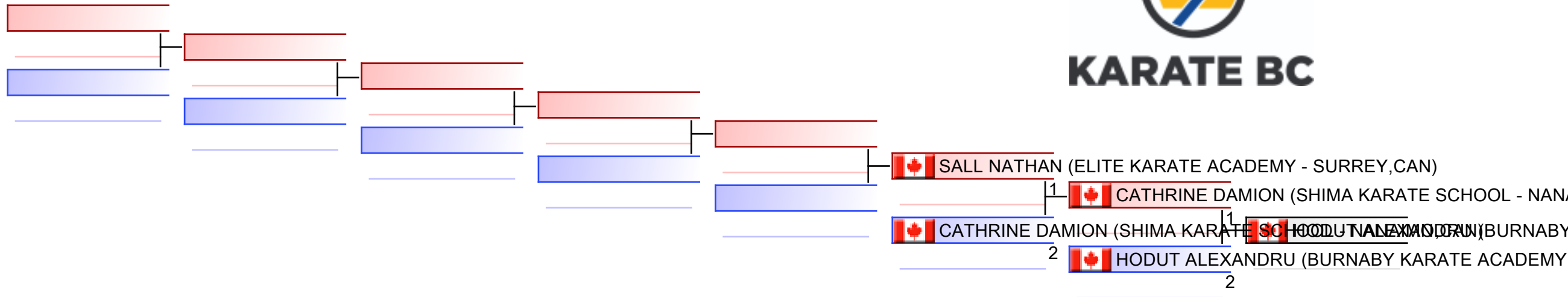

REPECHAGE: (1)

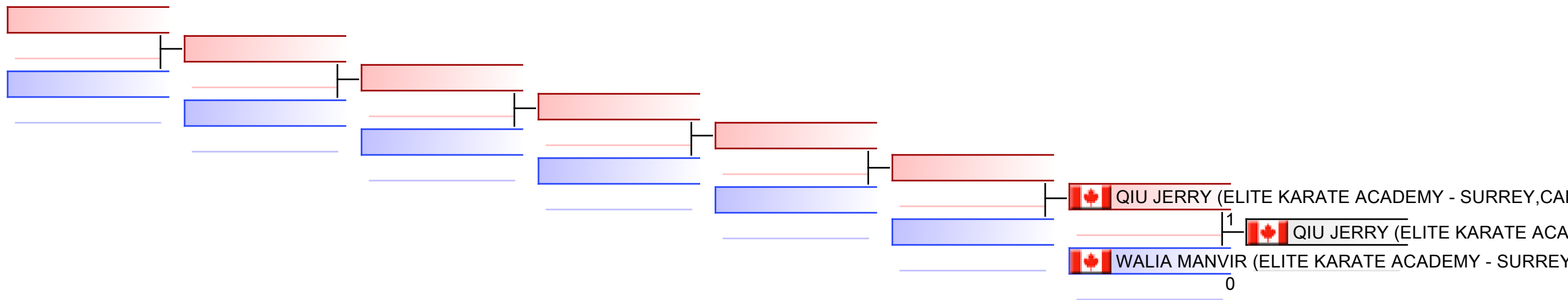









Referees:							
-----------	--	--	--	--	--	--	--

RS-2 Girls 8/9 - Kumite Novice - Round Robin (each against each)

2019 Karate BC Provincial Championships, CAN

Tatami
3 13:15

Pool
1/1

- 1  SCOTT JAIMEE (NORTH WEST SHITO-KAI,CAN)
 - 1  SNOW-KIMURA MIA (KINGSWAY SHITO-RYU,CAN)
- 2  SNOW-KIMURA MIA (KINGSWAY SHITO-RYU,CAN)
 - 6
- 3  SCOTT JAIMEE (NORTH WEST SHITO-KAI,CAN)
 - 1  FUNG ELISE (KINGSWAY SHITO-RYU,CAN)
- 4  FUNG ELISE (KINGSWAY SHITO-RYU,CAN)
 - 6
- 5  SNOW-KIMURA MIA (KINGSWAY SHITO-RYU,CAN)
 - 3  FUNG ELISE (KINGSWAY SHITO-RYU,CAN)
- 6  FUNG ELISE (KINGSWAY SHITO-RYU,CAN)
 - 6



1. FUNG ELISE (KINGSWAY SHITO-RYU,CAN)
2. SNOW-KIMURA MIA (KINGSWAY SHITO-RYU,CAN)
3. SCOTT JAIMEE (NORTH WEST SHITO-KAI,CAN)

Referees:				

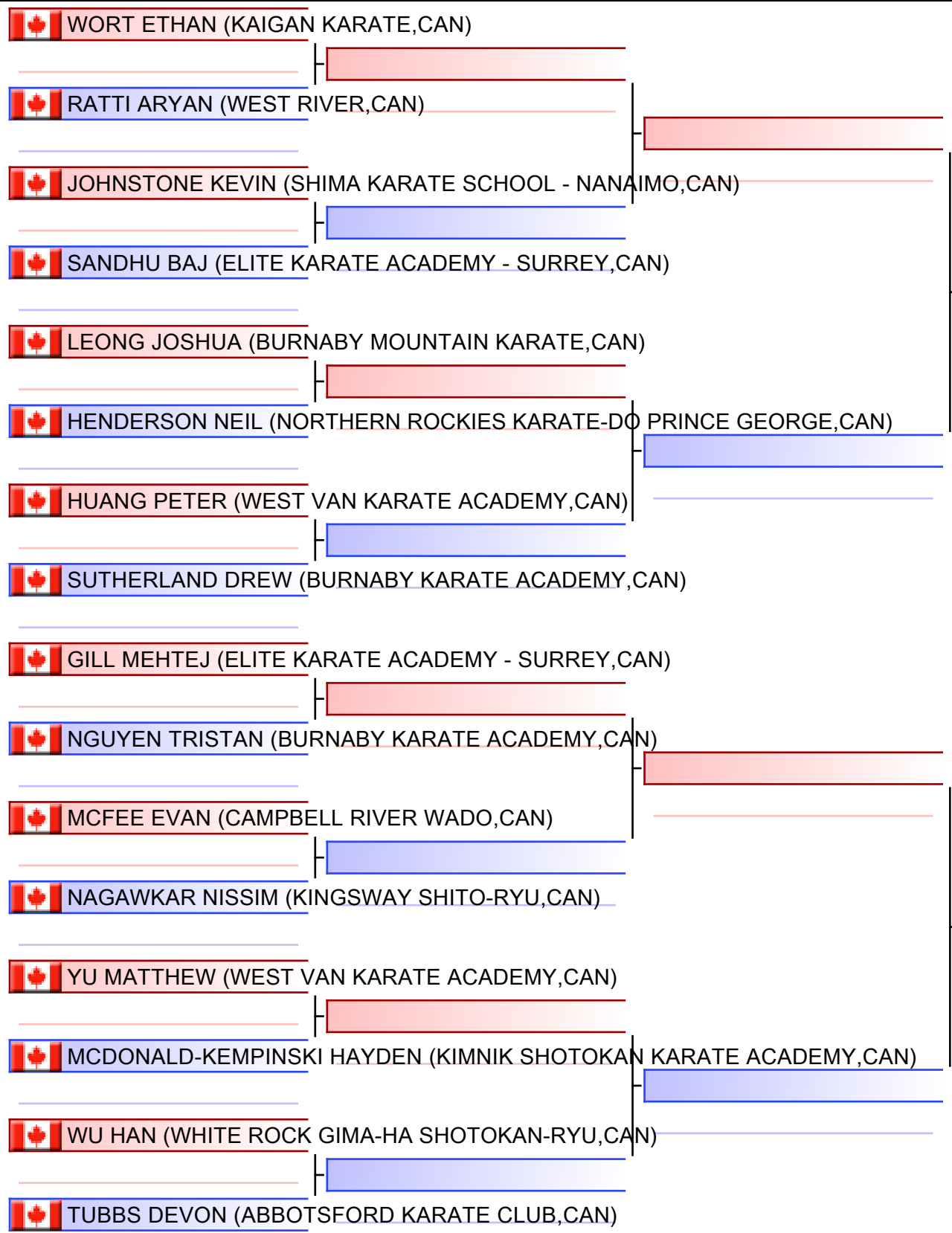

Final

Referees:			

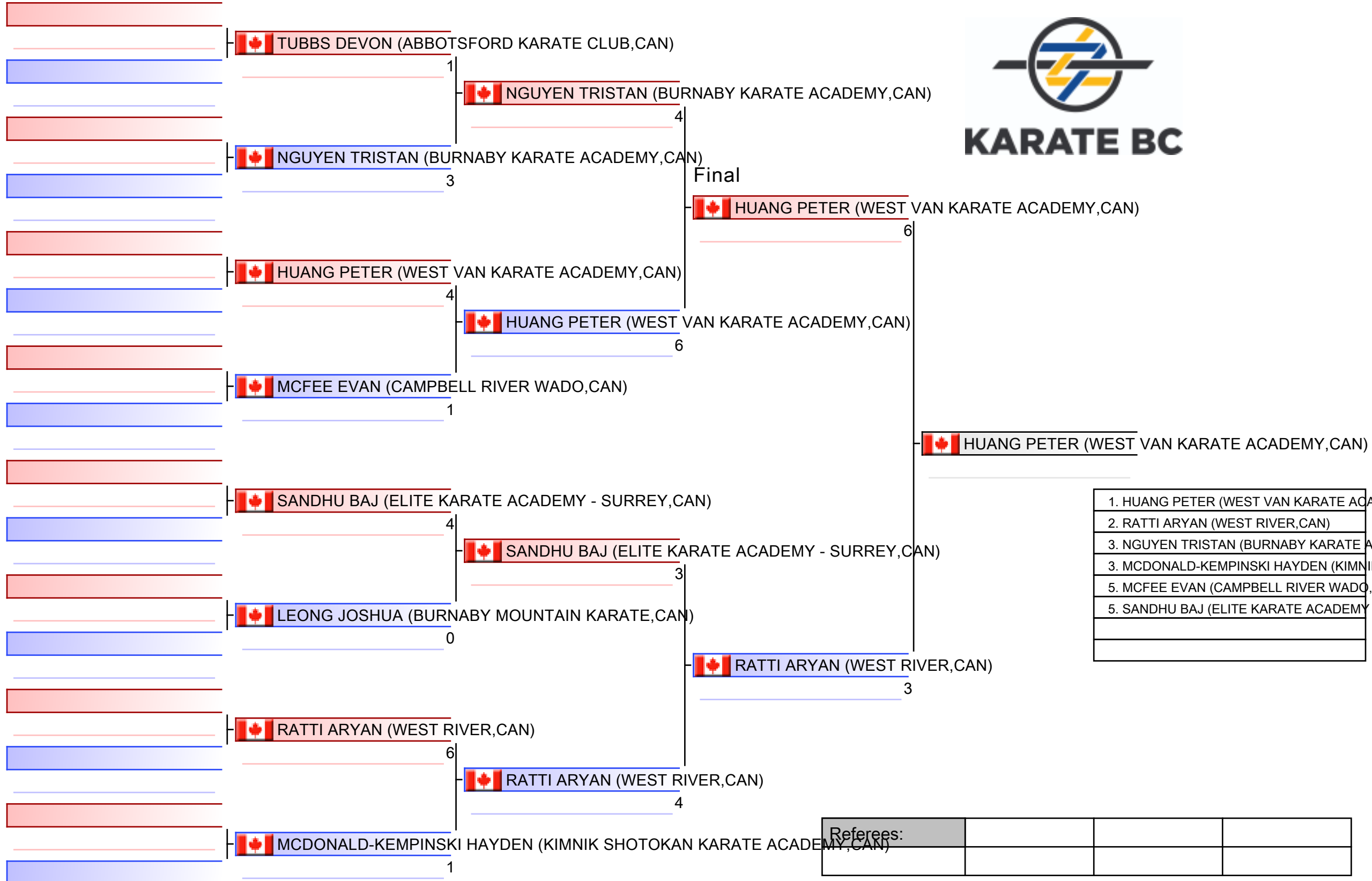

Referees:			

RS-30 Split 1 Boys 11 - Kumite Intermediate G1

2019 Karate BC Provincial Championships

(c)sportdata GmbH & Co KG 2000-2019(2019-12-04 00:10) -WKF Approved- v 9.8.6 build 2 License: Karate BC (expire 2020-10-12)

Tatami

Pool
1

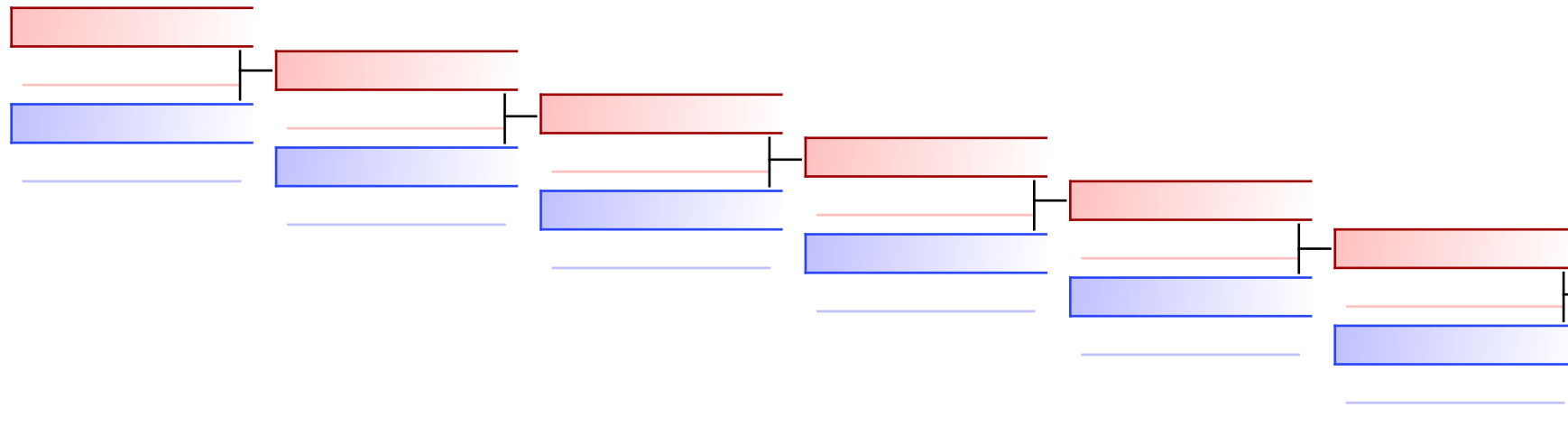

MCFEE EVAN (CAMPBELL RIVER WADO,CAN)

0 NGUYEN TRISTAN (BURNABY K

NGUYEN TRISTAN (BURNABY KARATE ACADEMY,CA

2

REPECHAGE: (1)

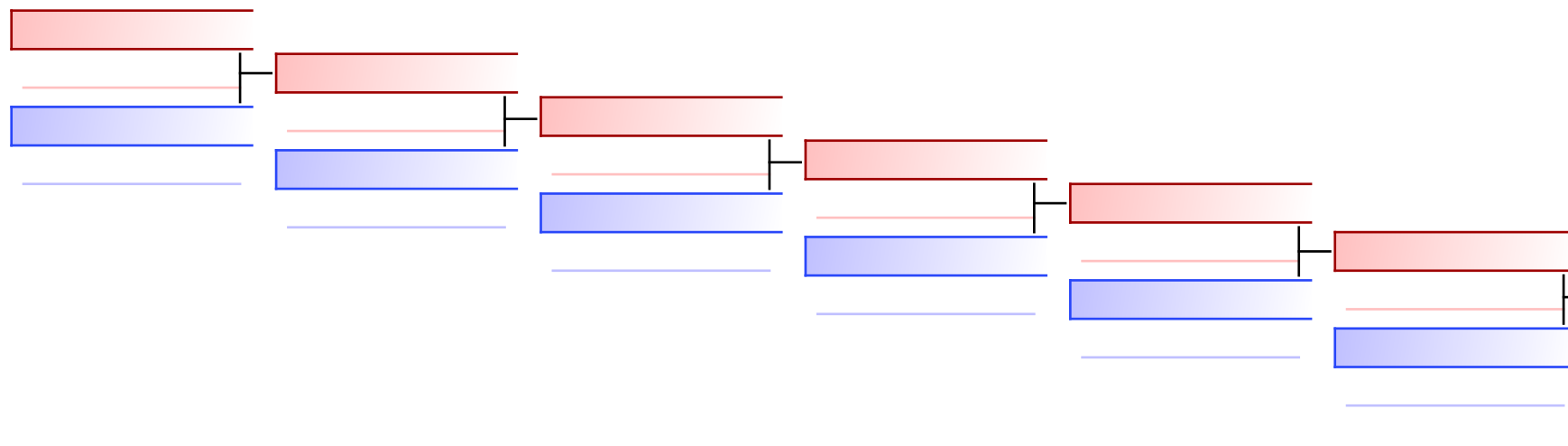

MCDONALD-KEMPINSKI HAYDEN (KIMNIK SHOTOKA

6 MCDONALD-KEMPINSKI HAYDE

SANDHU BAJ (ELITE KARATE ACADEMY - SURREY,C

2

Referees:							
-----------	--	--	--	--	--	--	--

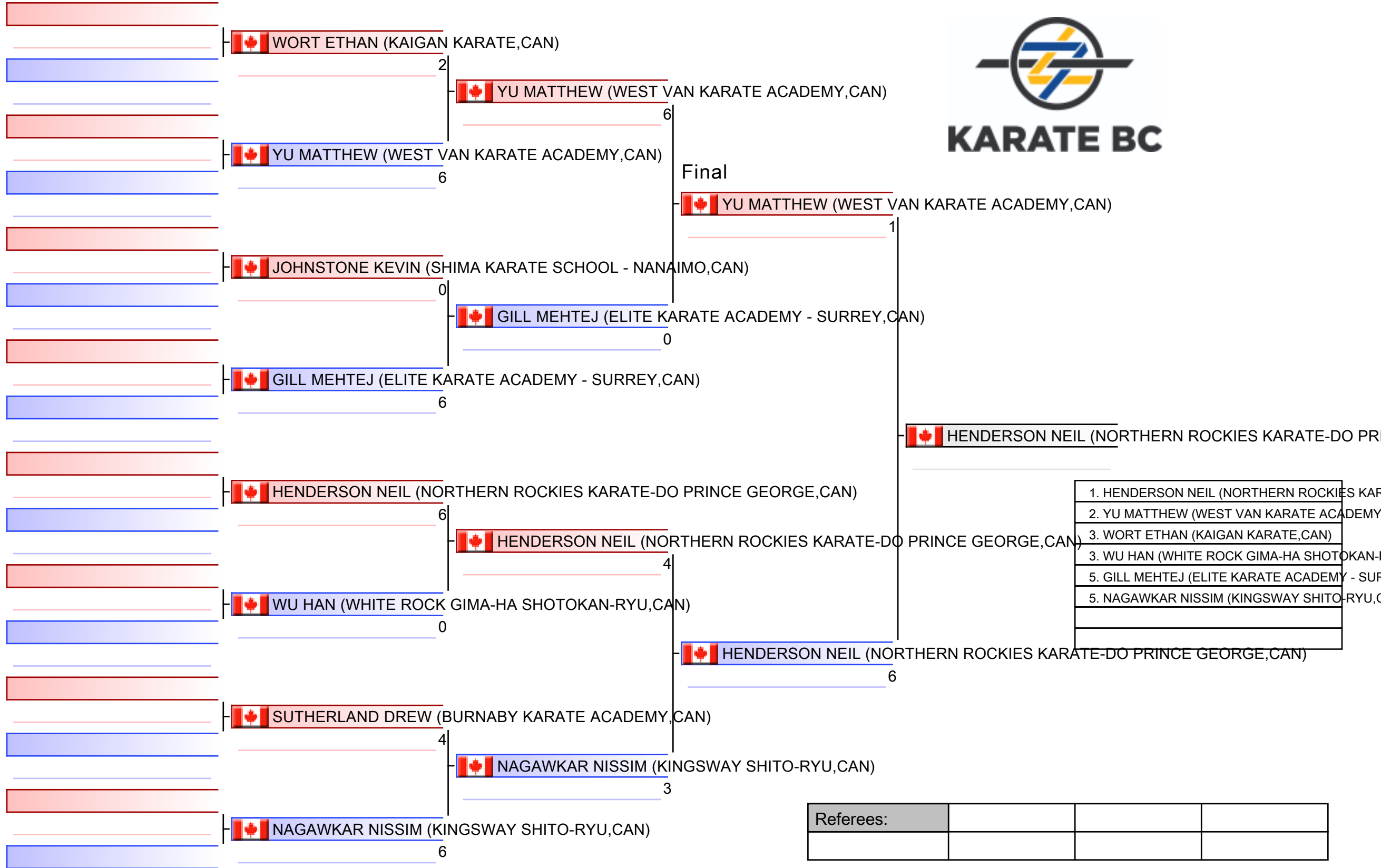

- | |
|---|
| 1. HENDERSON NEIL (NORTHERN ROCKIES KARATE-DO PRINCE GEORGE, CAN) |
| 2. YU MATTHEW (WEST VAN KARATE ACADEMY, CAN) |
| 3. WORT ETHAN (KAIGAN KARATE, CAN) |
| 3. WU HAN (WHITE ROCK GIMA-HA SHOTOKAN-RYU, CAN) |
| 5. GILL MEHTEJ (ELITE KARATE ACADEMY - SURREY, CAN) |
| 5. NAGAWKAR NISSIM (KINGSWAY SHITO-RYU, CAN) |
| |
| |

Referees:			

RS-30 Split 1 Boys 11 - Kumite Intermediate G2

2019 Karate BC Provincial Championships

(c)sportdata GmbH & Co KG 2000-2019(2019-12-04 00:10) -WKF Approved- v 9.8.6 build 2 License: Karate BC (expire 2020-10-12)

Tatami

Pool
1

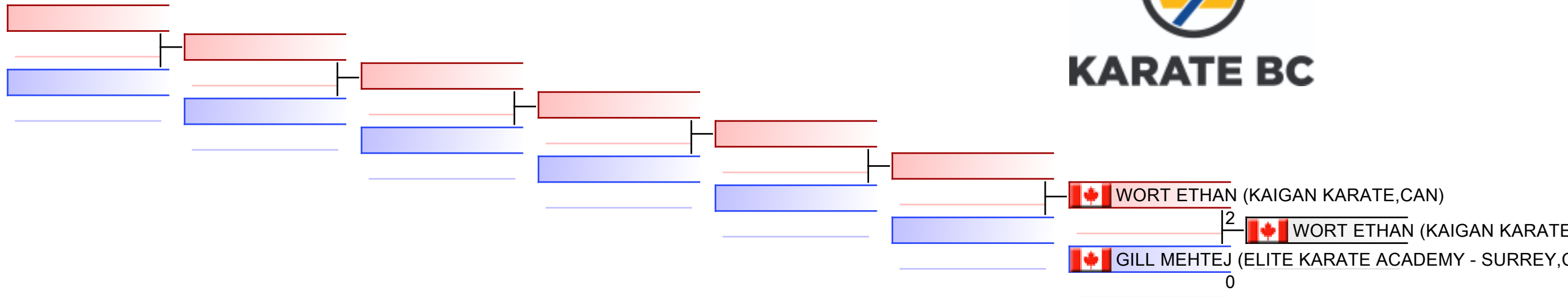

REPECHAGE: (1)

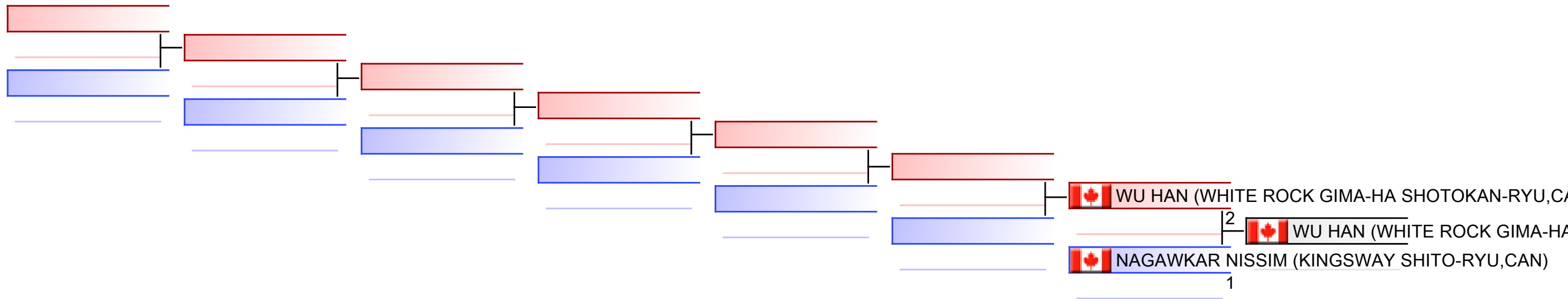

Referees:							
-----------	--	--	--	--	--	--	--



KARATE BC

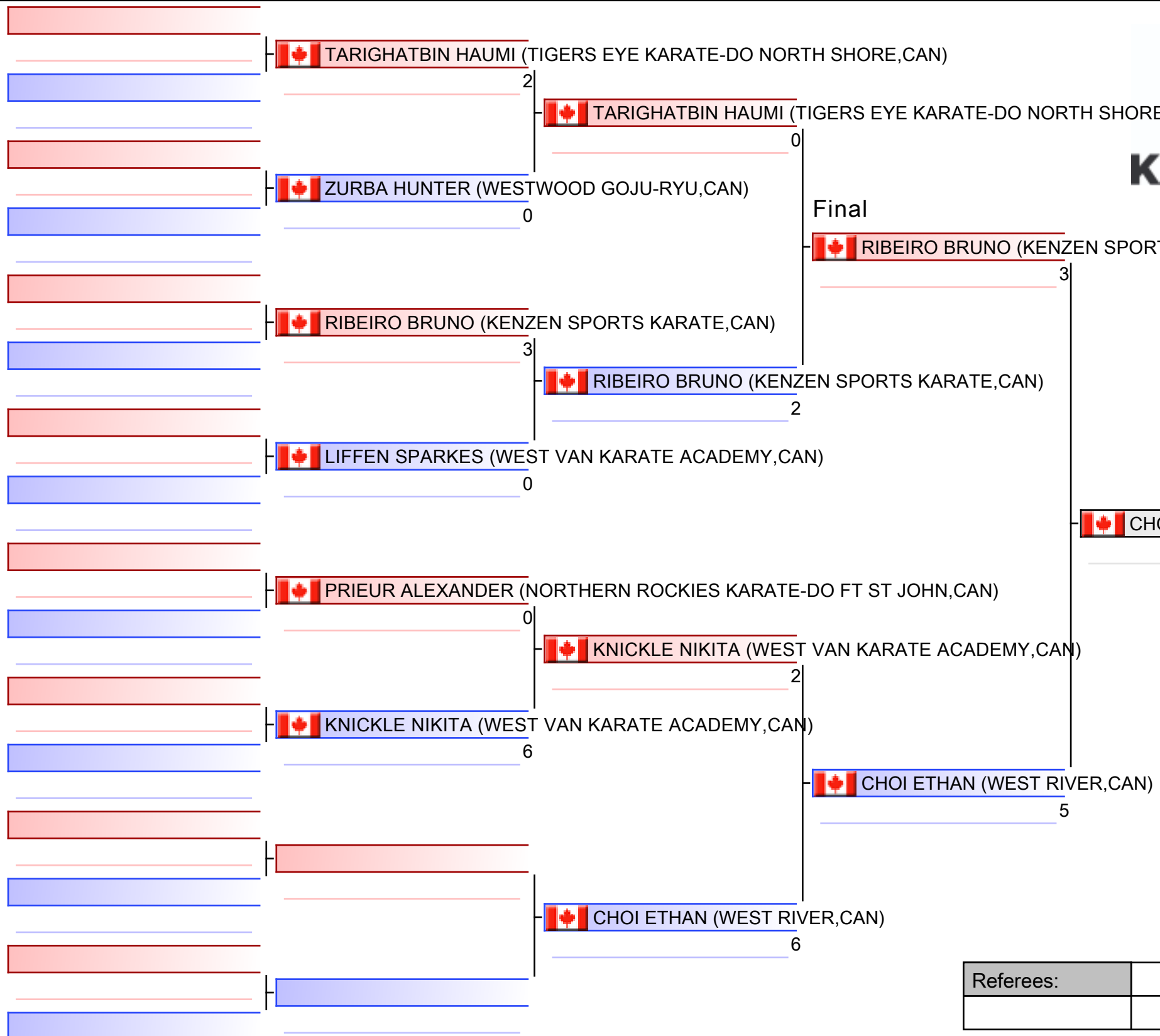

1. CHOI ETHAN (WEST RIVER,CAN)
2. RIBEIRO BRUNO (KENZEN SPORTS KARATE,CAN)
3. KNICKLE NIKITA (WEST VAN KARATE ACADEMY,CAN)
3. TARIGHATBIN HAUMI (TIGERS EYE KARATE-DO NORTH SHORE,CAN)
5. LIFFEN SPARKES (WEST VAN KARATE ACADEMY,CAN)

Referees:			

RS-30 Split 2 Boys 10 - Kumite Intermediate

2019 Karate BC Provincial Championships

Tatami
5 14:00

Pool
1

(c)sportdata GmbH & Co KG 2000-2019(2019-12-04 00:11) -WKF Approved- v 9.8.6 build 2 License: Karate BC (expire 2020-10-12)

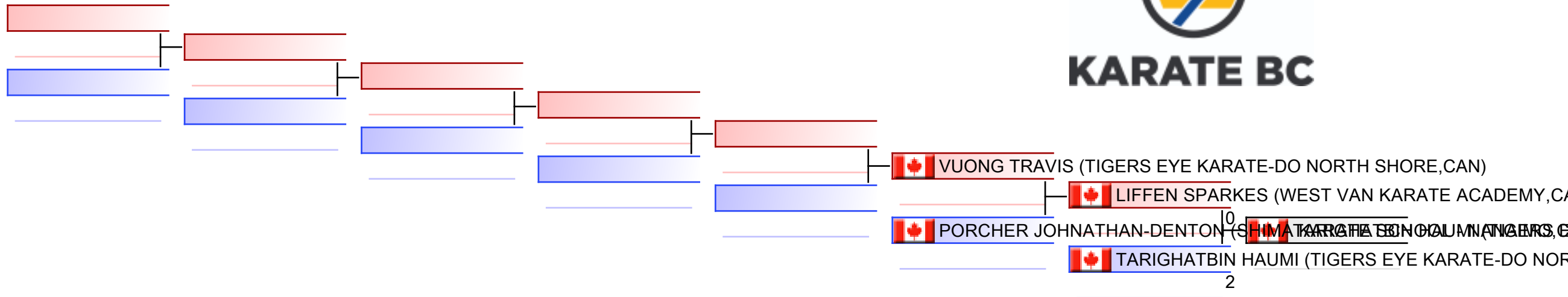

REPECHAGE: (1)

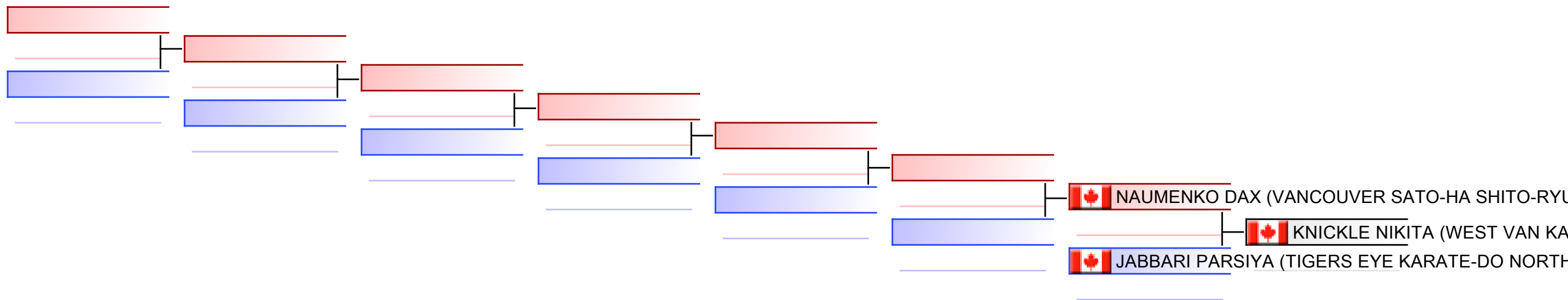

Referees:							
-----------	--	--	--	--	--	--	--

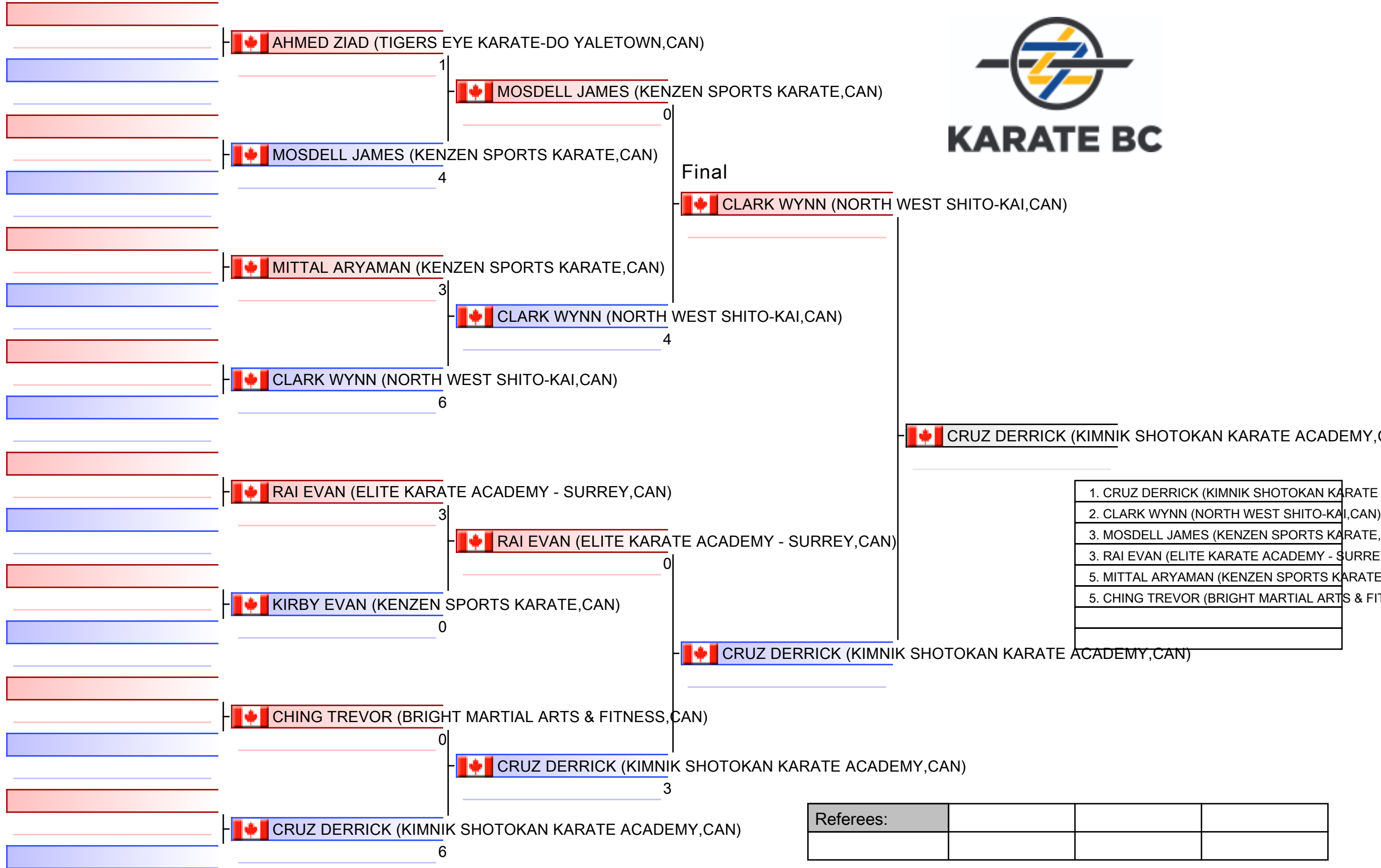

Referees:			

RS-31 Boys 10/11 - Kumite Adv/Black



2019 Karate BC Provincial Championships

(c)sportdata GmbH & Co KG 2000-2019(2019-12-04 00:11) -WKF Approved- v 9.8.6 build 2 License: Karate BC (expire 2020-10-12)

Tatami
1 15:05

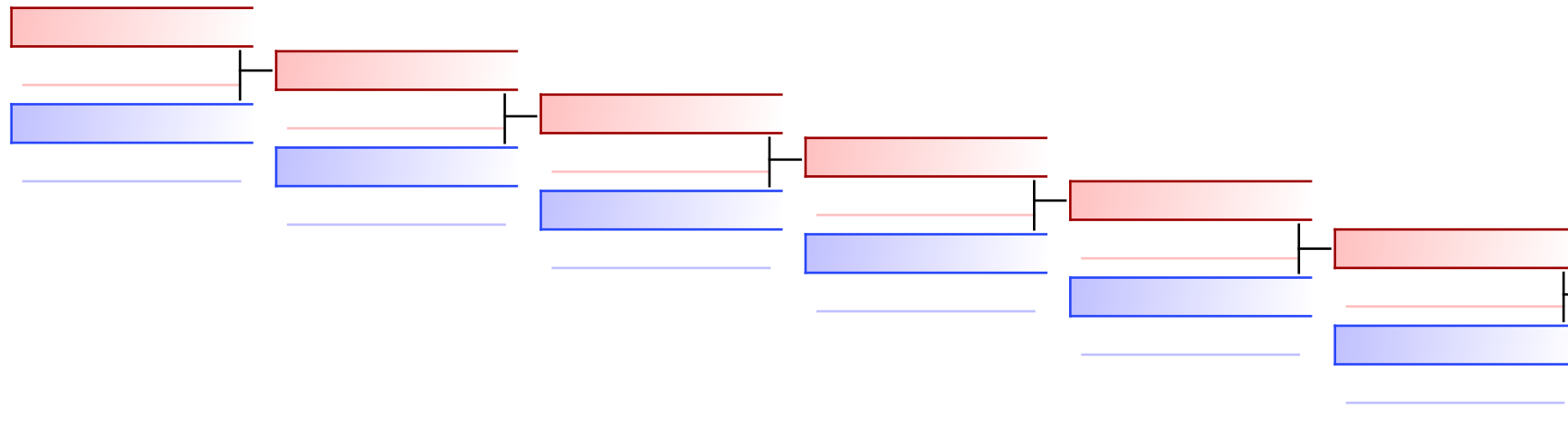

Pool
1

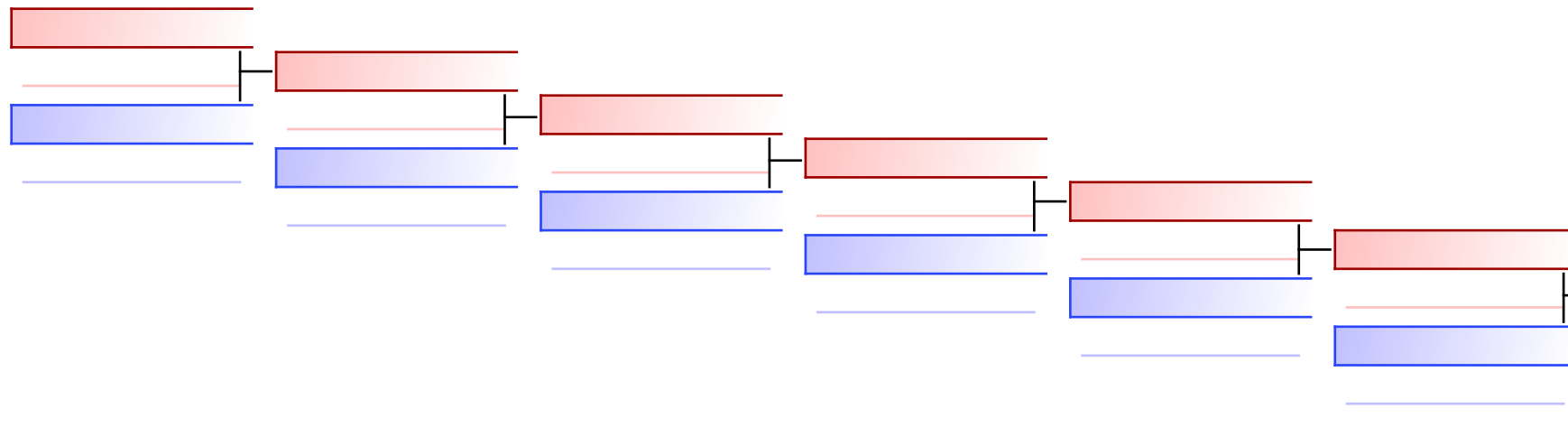

 MITTAL ARYAMAN (KENZEN SPORTS KARATE,CAN)
 0
 MOSDELL JAMES (KENZEN SPO
 MOSDELL JAMES (KENZEN SPORTS KARATE,CAN)
 4

REPECHAGE: (1)



 CHING TREVOR (BRIGHT MARTIAL ARTS & FITNESS,
 0
 RAI EVAN (ELITE KARATE ACAD
 RAI EVAN (ELITE KARATE ACADEMY - SURREY,CAN
 2

Referees:							
-----------	--	--	--	--	--	--	--

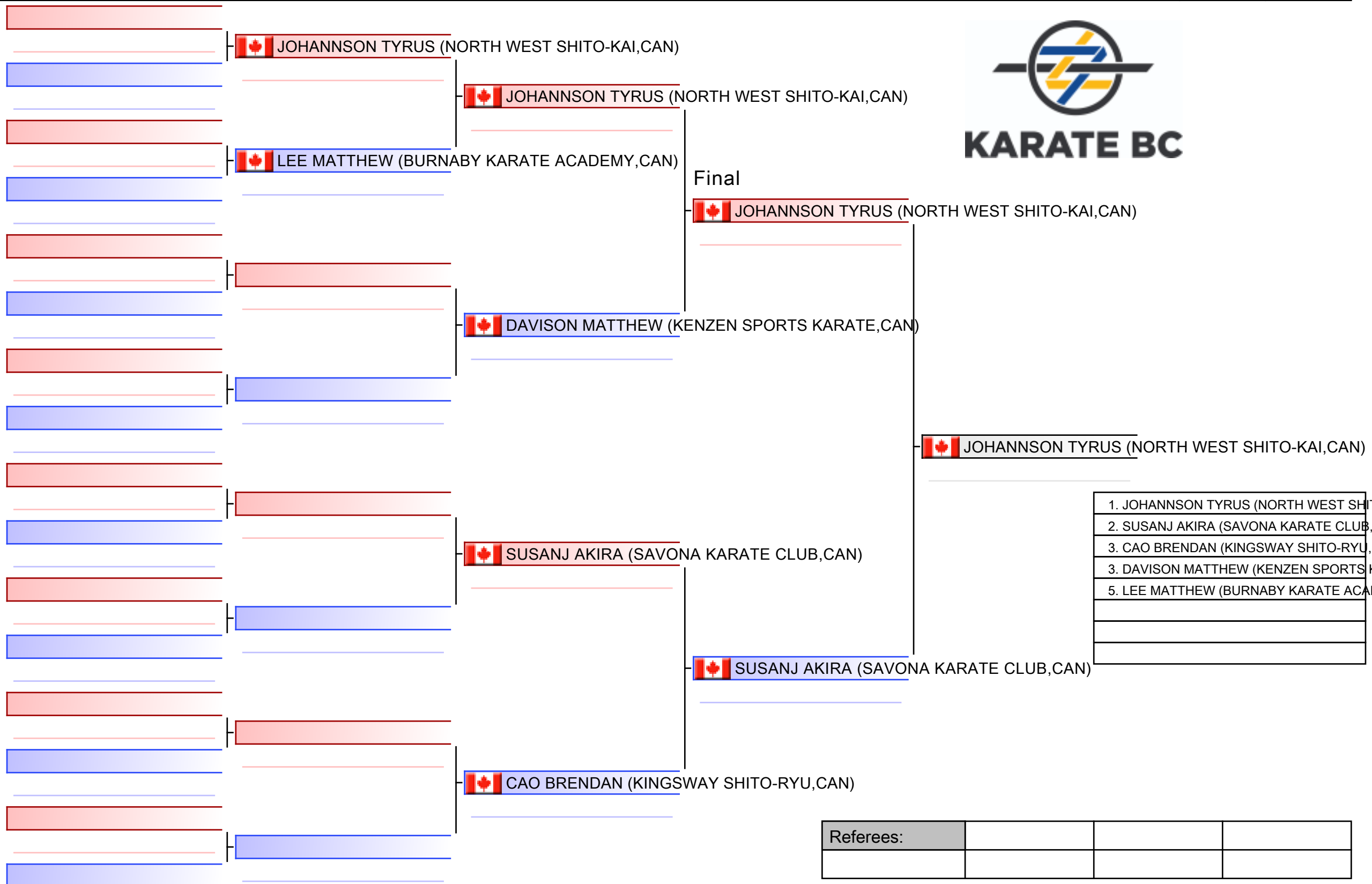

RS-33 Split 1 Boys 13 - Kumite Intermediate

2019 Karate BC Provincial Championships

Tatami
5 14:40

Pool
1

(c)sportdata GmbH & Co KG 2000-2019(2019-12-04 00:11) -WKF Approved- v 9.8.6 build 2 License: Karate BC (expire 2020-10-12)

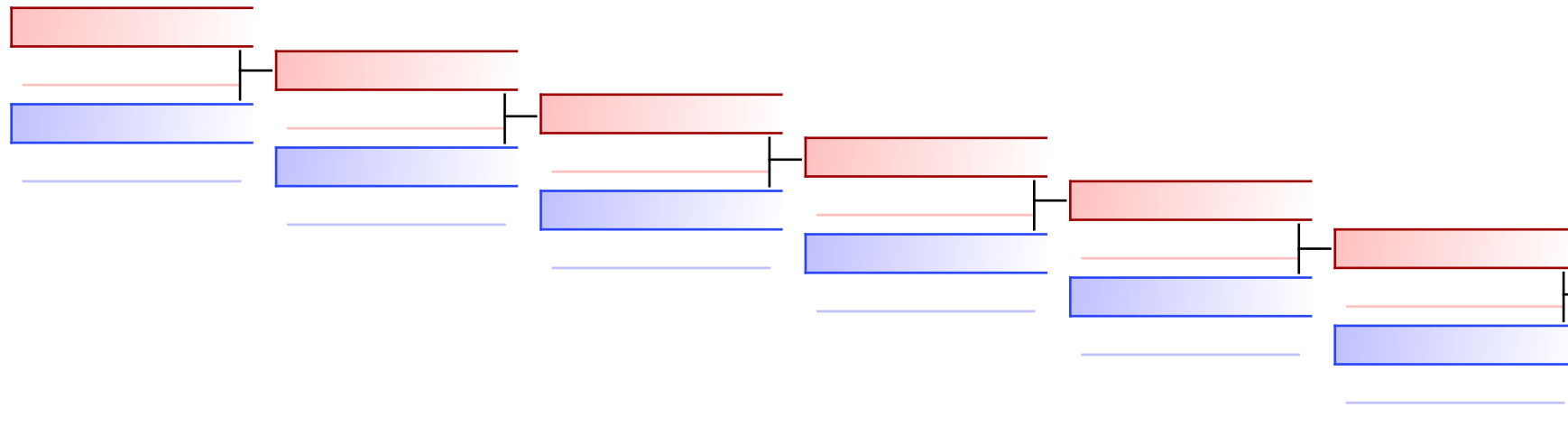

 LEE MATTHEW (BURNABY KARATE ACADEMY,CAN)
 DAVISON MATTHEW (KENZEN S
 DAVISON MATTHEW (KENZEN SPORTS KARATE,CAN

REPECHAGE: (1)

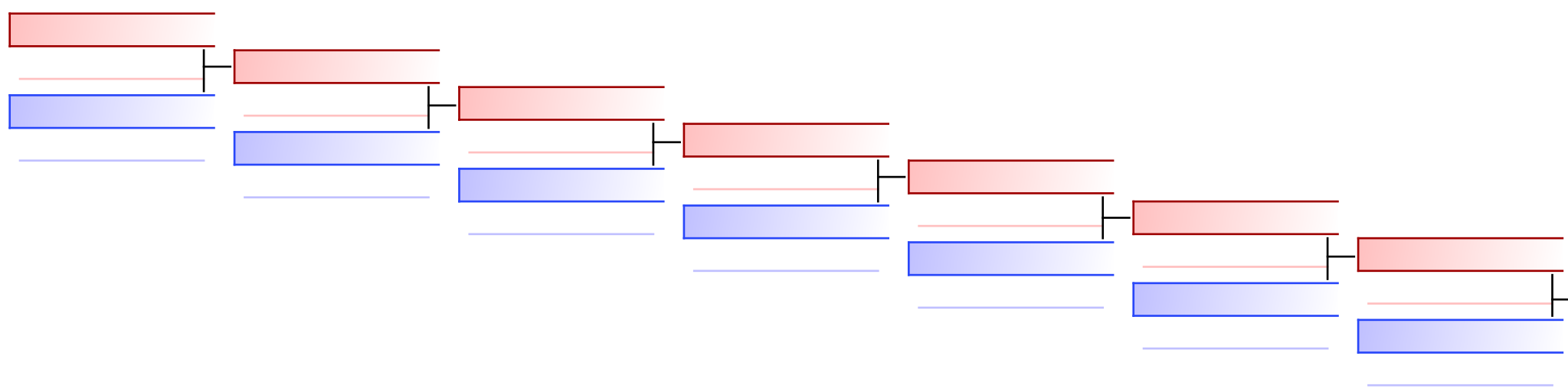

 CAO BRENDAN (KINGSWAY SHI

Referees:							
-----------	--	--	--	--	--	--	--

RS-33 Split 2 Boys 12 - Kumite Intermediate

2019 Karate BC Provincial Championships, CAN

Tatami
2 15:10

Pool
1/1

 HRADEC GABRIEL (WEST RIVER,CAN)

 TEAGUE ALEXANDER (SAVONA KARATE CLUB,CAN)

 TEAGUE ALEXANDER (SAVONA KARATE CLUB,CAN)

 TEAGUE ALEXANDER (SAVONA KARATE CLUB,CAN)

 VIG KEATON (NORTHERN ROCKIES KARATE-DO HUDSONS HOPE,CAN)

Final

 BRADSHAW QUINN (WEST VAN KARATE ACADEMY,CAN)

 BRADSHAW QUINN (WEST VAN KARATE ACADEMY,CAN)

 BRADSHAW QUINN (WEST VAN KARATE ACADEMY,CAN)

 YOUSEFI_FARID EASHA (TIGERS EYE KARATE-DO NORTH SHORE,CAN)

 BRADSHAW QUINN (WEST VAN KARATE ACADEMY,CAN)

 DANESH DANIEL (TIGERS EYE KARATE-DO NORTH SHORE,CAN)

 PRIEUR NOAH (NORTHERN ROCKIES KARATE-DO FT ST JOHN,CAN)

 PRIEUR NOAH (NORTHERN ROCKIES KARATE-DO FT ST JOHN,CAN)

 ABENES BRENDAN (KINGSWAY SHITO-RYU,CAN)

 ABENES BRENDAN (KINGSWAY SHITO-RYU,CAN)

 ABENES BRENDAN (KINGSWAY SHITO-RYU,CAN)

 FUGGERSBERGER ISAAC (WEST RIVER,CAN)



- | |
|---|
| 1. BRADSHAW QUINN (WEST VAN KARATE ACADEMY,CAN) |
| 2. ABENES BRENDAN (KINGSWAY SHITO-RYU,CAN) |
| 3. TEAGUE ALEXANDER (SAVONA KARATE CLUB,CAN) |
| 3. PRIEUR NOAH (NORTHERN ROCKIES KARATE-DO FT ST JOHN,CAN) |
| 5. YOUSEFI_FARID EASHA (TIGERS EYE KARATE-DO NORTH SHORE,CAN) |
| 5. FUGGERSBERGER ISAAC (WEST RIVER,CAN) |
| |
| |

Referees:			

RS-33 Split 2 Boys 12 - Kumite Intermediate

2019 Karate BC Provincial Championships

Tatami
2 15:40

Pool
1

(c)sportdata GmbH & Co KG 2000-2019(2019-12-04 00:11) -WKF Approved- v 9.8.6 build 2 License: Karate BC (expire 2020-10-12)

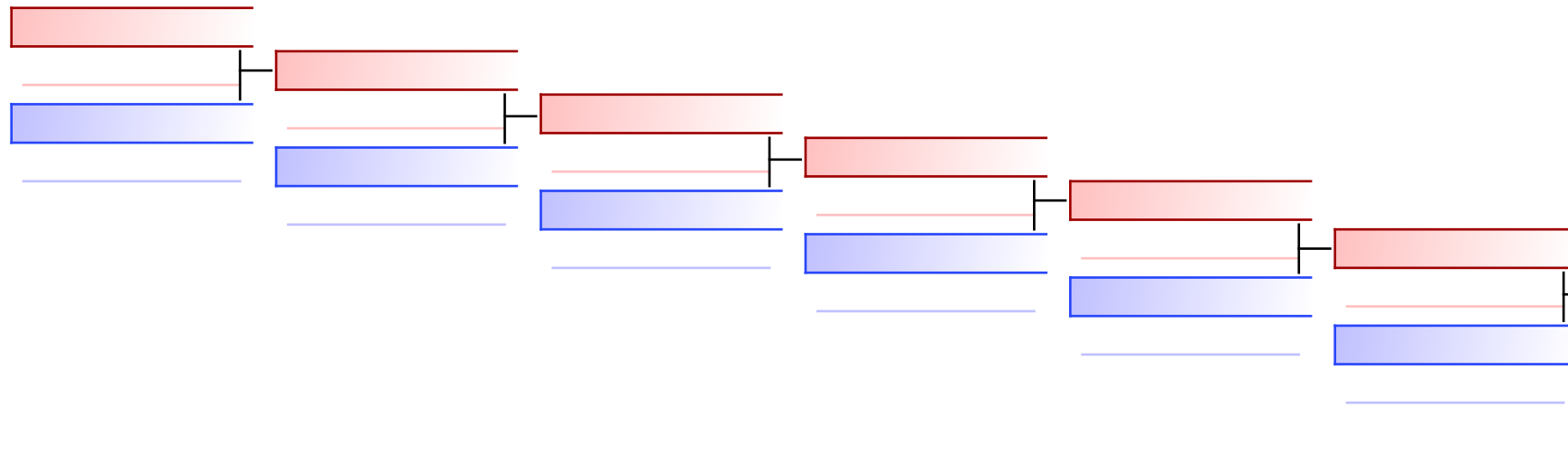

YOUSEFI_FARID EASHA (TIGERS EYE KARATE-DO M...)
 TEAGUE ALEXANDER (SAVONA...)
 TEAGUE ALEXANDER (SAVONA KARATE CLUB,CAN...)

REPECHAGE: (1)

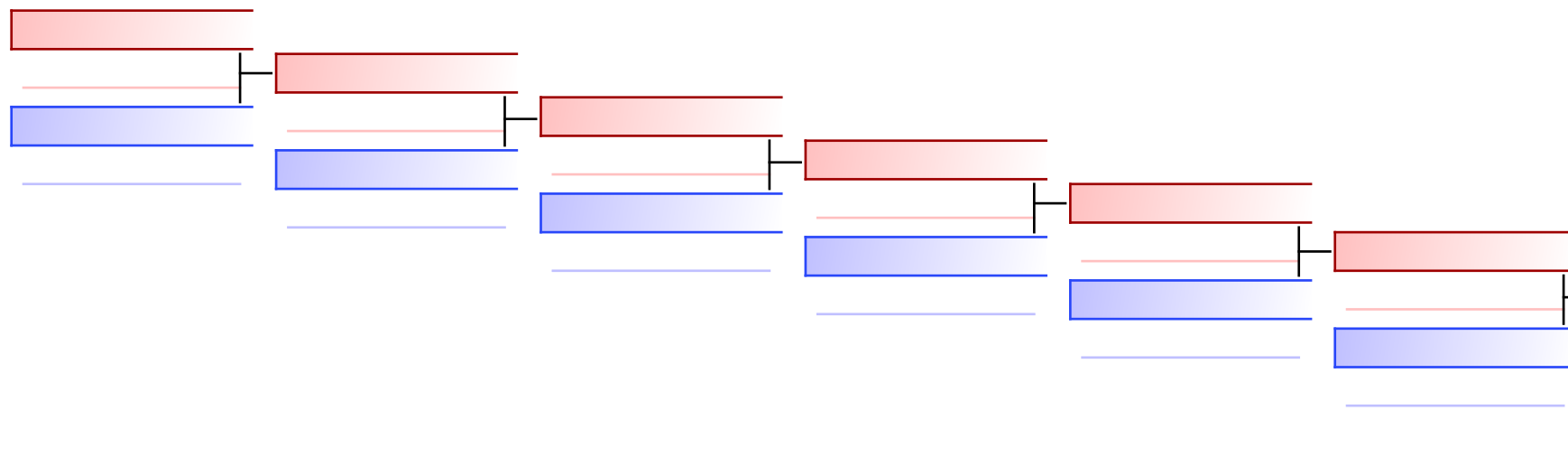

FUGGERSBERGER ISAAC (WEST RIVER,CAN)
 PRIEUR NOAH (NORTHERN RO...)
 PRIEUR NOAH (NORTHERN ROCKIES KARATE-DO FT...)

Referees:							
-----------	--	--	--	--	--	--	--

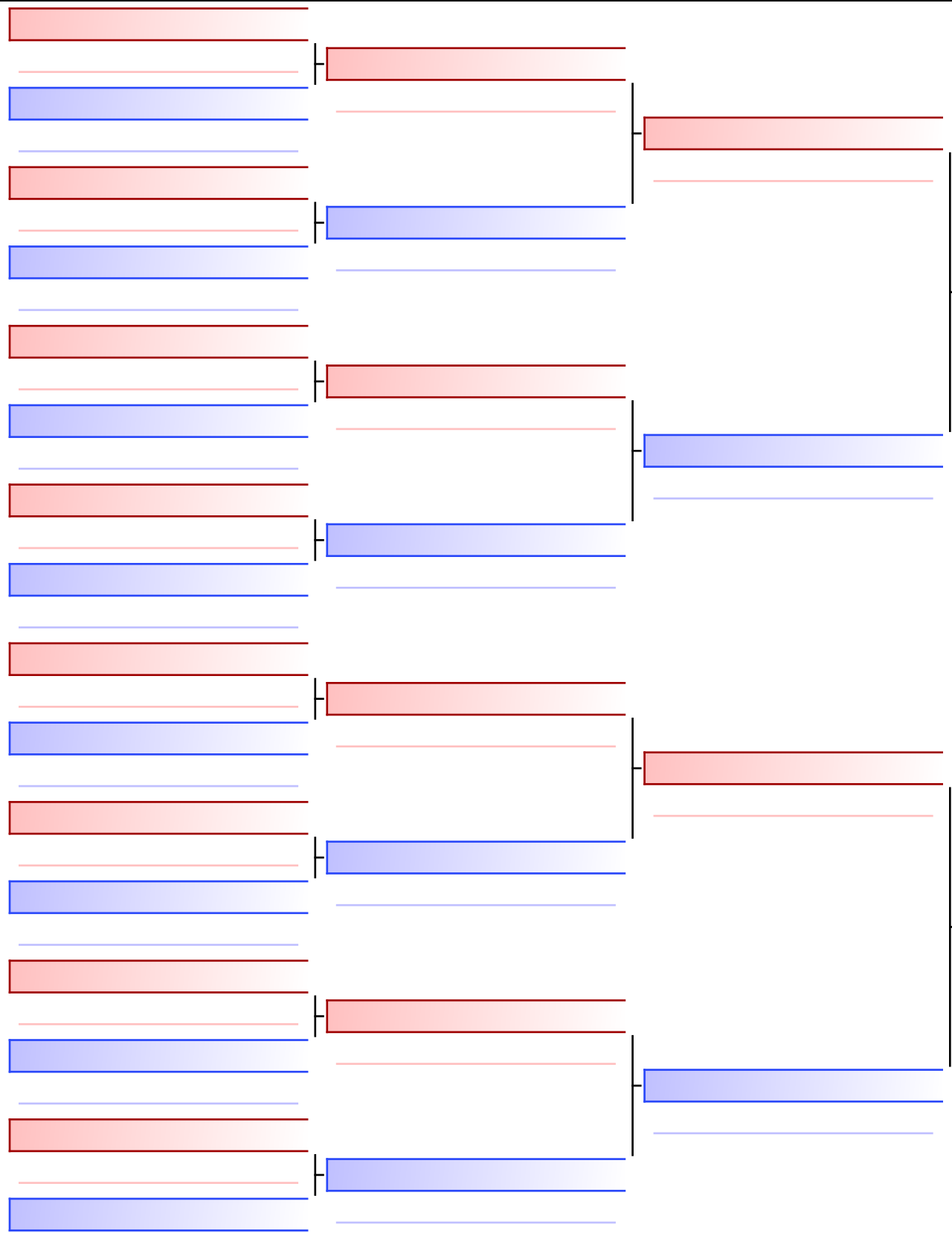

Final

BRAR PARVIR (ELITE KARATE ACADEMY - SURREY,CAN)

EZAKI HIKARU (WHITE ROCK GIMA-HA SHOTOKAN-RYU,CAN)

EZAKI HIKARU (WHITE ROCK GIMA-HA SHOTOKAN-RYU,CAN)

1. EZAKI HIKARU (WHITE ROCK GIMA-HA SHOTO
2. BRAR PARVIR (ELITE KARATE ACADEMY - SUR

Referees:			

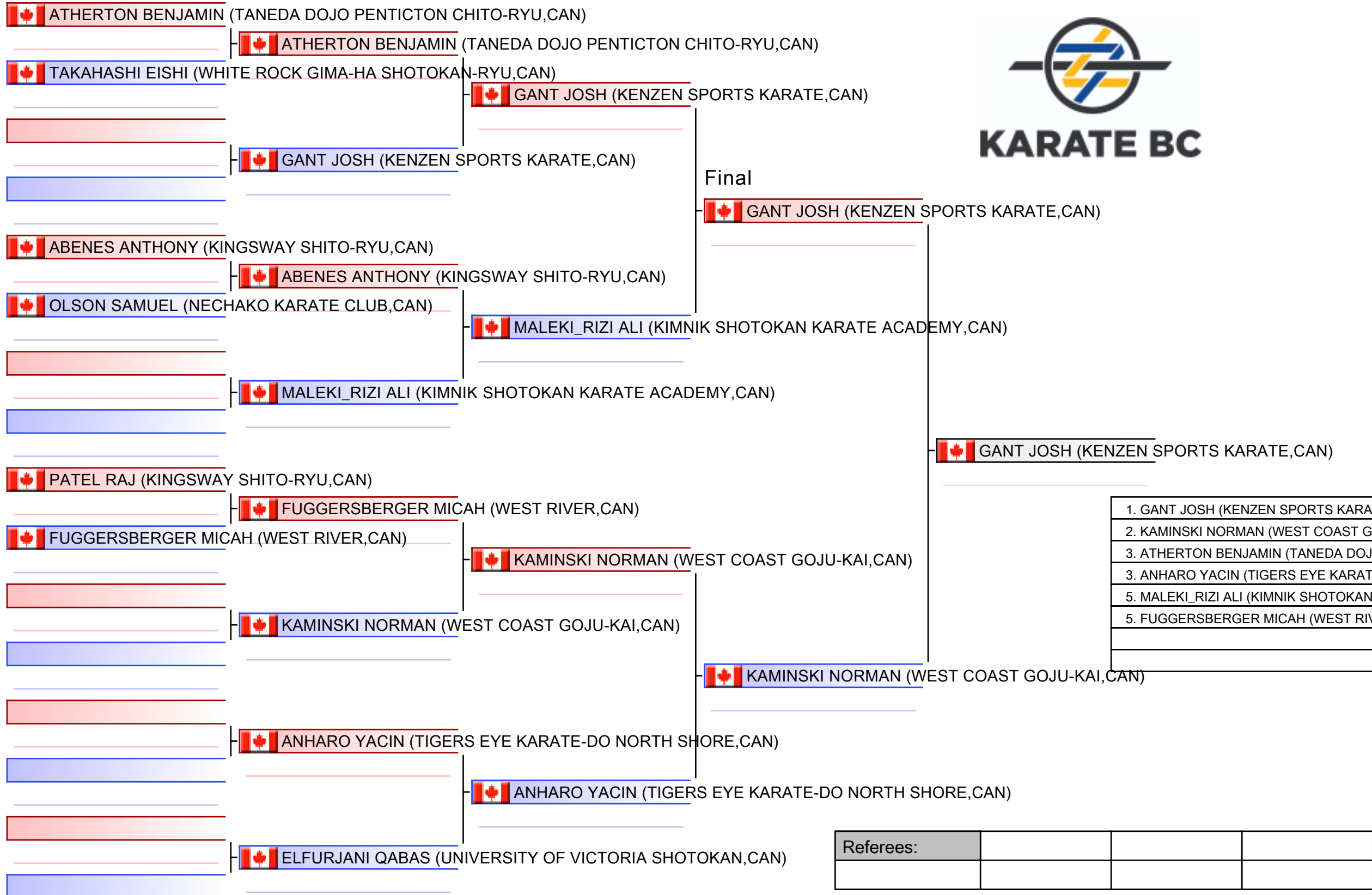

RS-36 Boys 14/15 - Kumite Int

2019 Karate BC Provincial Championships

Tatami
4 15:25

Pool
1

(c)sportdata GmbH & Co KG 2000-2019(2019-12-04 00:11) -WKF Approved- v 9.8.6 build 2 License: Karate BC (expire 2020-10-12)

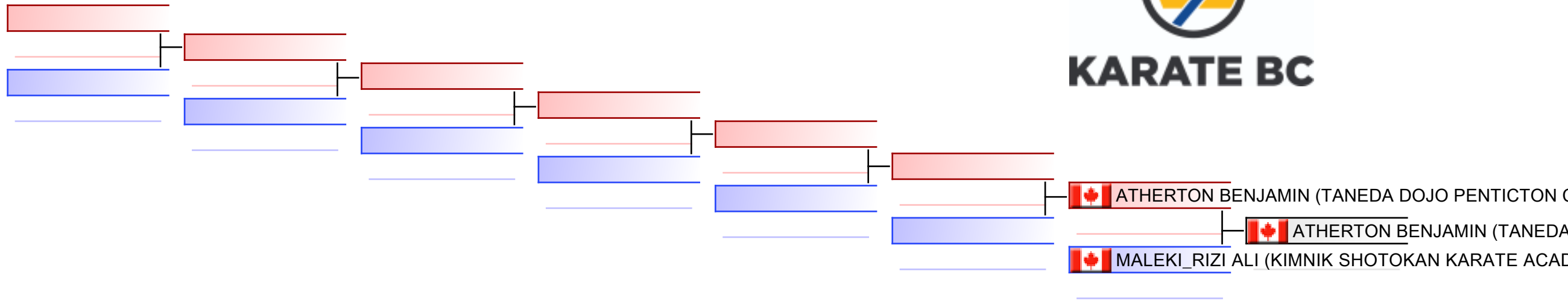

REPECHAGE: (1)

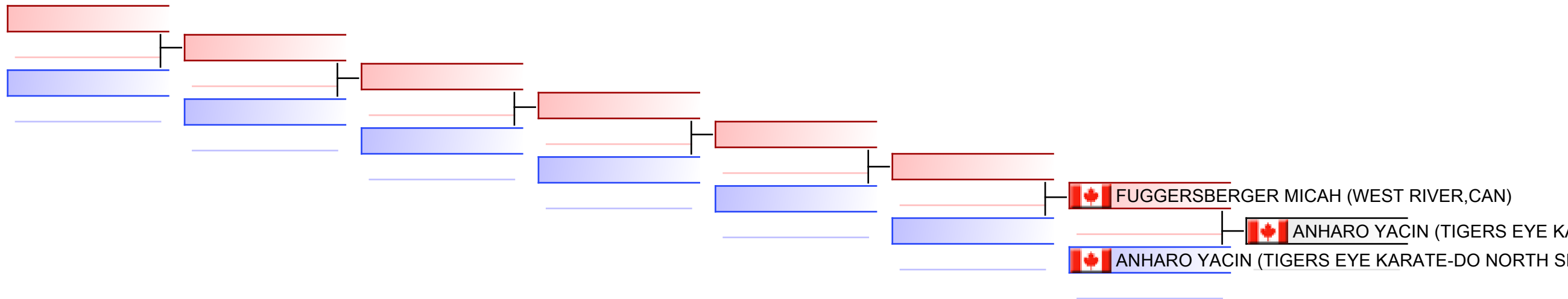

Referees:							
-----------	--	--	--	--	--	--	--



KARATE BC

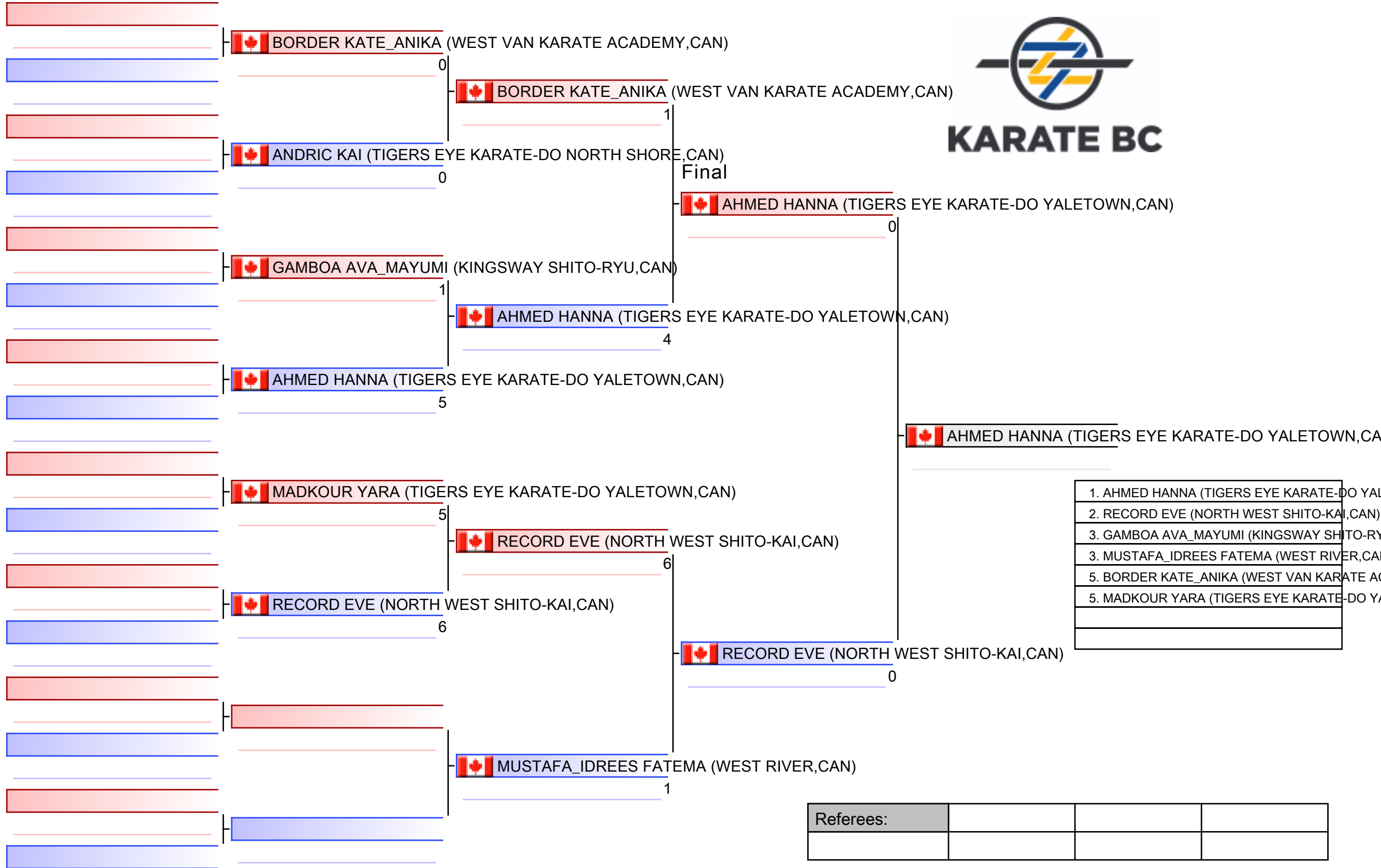

- | |
|--|
| 1. AHMED HANNA (TIGERS EYE KARATE-DO YALETOWN, CAN) |
| 2. RECORD EVE (NORTH WEST SHITO-KAI, CAN) |
| 3. GAMBOA AVA_MAYUMI (KINGSWAY SHITO-RYU, CAN) |
| 3. MUSTAFA_IDREES FATEMA (WEST RIVER, CAN) |
| 5. BORDER KATE_ANIKA (WEST VAN KARATE ACADEMY, CAN) |
| 5. MADKOUR YARA (TIGERS EYE KARATE-DO YALETOWN, CAN) |
| |
| |

Referees:			

RS-3 Girls 8/9 - Kumite Intermediate

2019 Karate BC Provincial Championships

Tatami
5 12:40

Pool
1

(c)sportdata GmbH & Co KG 2000-2019(2019-12-04 00:10) -WKF Approved- v 9.8.6 build 2 License: Karate BC (expire 2020-10-12)

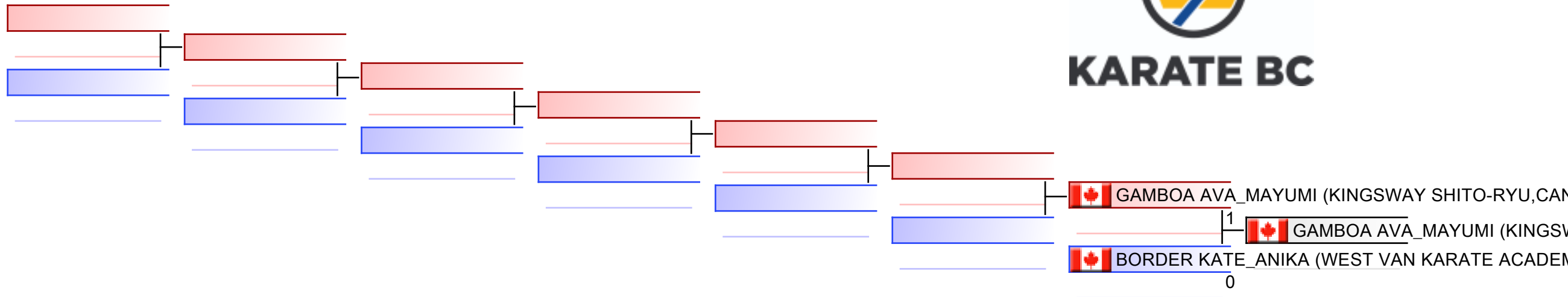

REPECHAGE: (1)

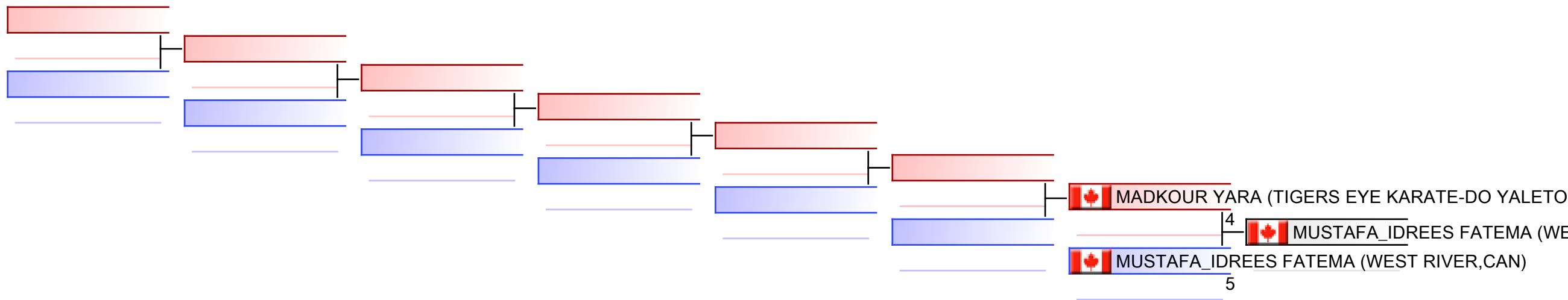

Referees:							
-----------	--	--	--	--	--	--	--

RS-43 Mens Kumite Intermediate - Round Robin (each against each)

2019 Karate BC Provincial Championships, CAN

Tatami
5 15:20

Pool
1/1

1  QUAALE LLOYD (KUMAKAI KARATE VANCOUVER,CAN)

 CHOI JASON (WEST RIVER,CAN)

2  CHOI JASON (WEST RIVER,CAN)

3  QUAALE LLOYD (KUMAKAI KARATE VANCOUVER,CAN)

 POLANSKI MICHAL (WESTWOOD GOJU-RYU,CAN)

4  POLANSKI MICHAL (WESTWOOD GOJU-RYU,CAN)

5  CHOI JASON (WEST RIVER,CAN)

 CHOI JASON (WEST RIVER,CAN)

6  POLANSKI MICHAL (WESTWOOD GOJU-RYU,CAN)



1. CHOI JASON (WEST RIVER,CAN)
2. POLANSKI MICHAL (WESTWOOD GOJU-RYU,CAN)
3. QUAALE LLOYD (KUMAKAI KARATE VANCOUVER,CAN)

Referees:			

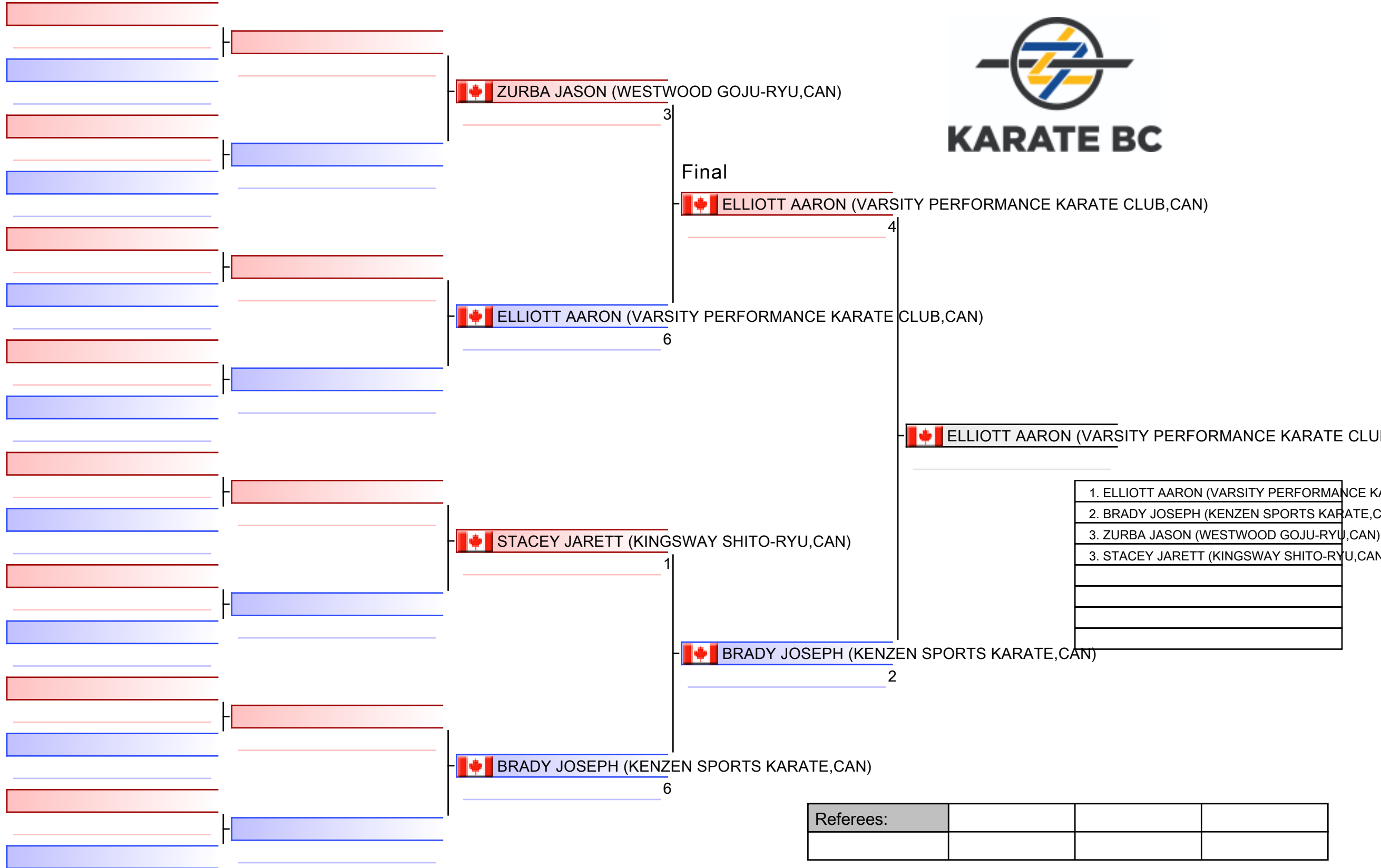

1. ELLIOTT AARON (VARSITY PERFORMANCE KARATE CLUB,CAN)
2. BRADY JOSEPH (KENZEN SPORTS KARATE,CAN)
3. ZURBA JASON (WESTWOOD GOJU-RYU,CAN)
3. STACEY JARETT (KINGSWAY SHITO-RYU,CAN)

Referees:			

RS-44 Mens Kumite Advanced

2019 Karate BC Provincial Championships

(c)sportdata GmbH & Co KG 2000-2019(2019-12-04 00:11) -WKF Approved- v 9.8.6 build 2 License: Karate BC (expire 2020-10-12)

Tatami

Pool
1

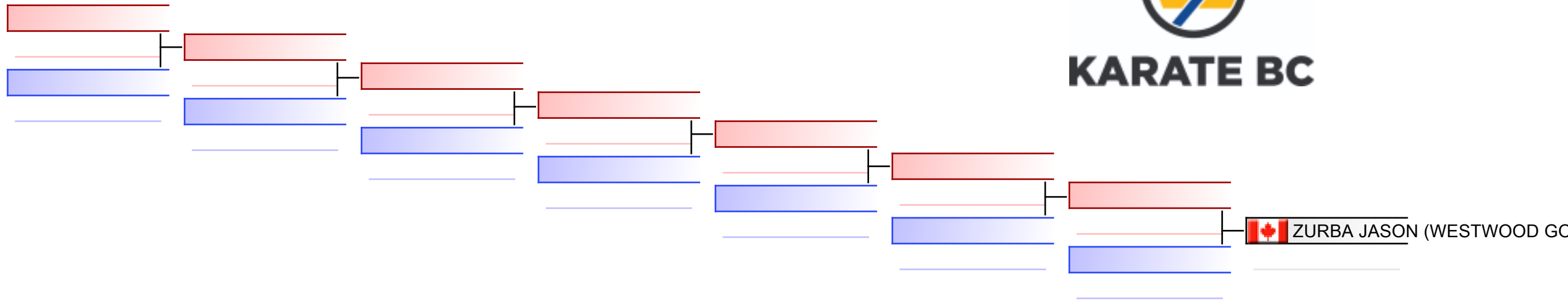

REPECHAGE: (1)

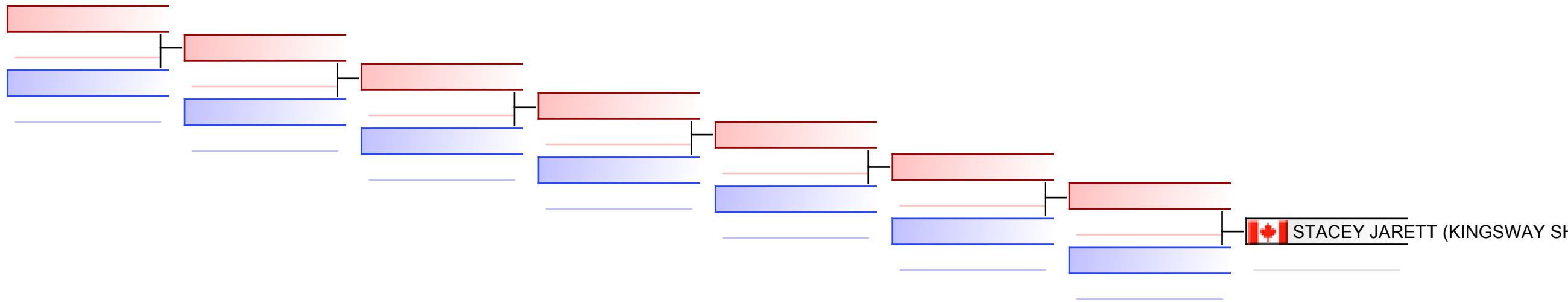









Referees:							
-----------	--	--	--	--	--	--	--

RS-45 Mens Kumite Black - Recreational - Round Robin (each against each)

2019 Karate BC Provincial Championships, CAN

Tatami
4 15:45

Pool
1/1

- 1  ARAKAKI_NEVES KIMAR (WEST COAST GOJU-KAI,CAN)
|  CLAUSEN CALEN (NORTH WEST SHITO-KAI,CAN)
- 2  CLAUSEN CALEN (NORTH WEST SHITO-KAI,CAN)
- 3  ARAKAKI_NEVES KIMAR (WEST COAST GOJU-KAI,CAN)
|  ARAKAKI_NEVES KIMAR (WEST COAST GOJU-KAI,CAN)
- 4  CHEN MUTTE (SOUTH SURREY KARATE CLUB,CAN)
- 5  CLAUSEN CALEN (NORTH WEST SHITO-KAI,CAN)
|  CLAUSEN CALEN (NORTH WEST SHITO-KAI,CAN)
- 6  CHEN MUTTE (SOUTH SURREY KARATE CLUB,CAN)



1. CLAUSEN CALEN (NORTH WEST SHITO-KAI,CAN)	KAI,CAN
2. ARAKAKI_NEVES KIMAR (WEST COAST GOJU-	GOJU-
3. CHEN MUTTE (SOUTH SURREY KARATE CLUB	CLUB

Referees:				

RS-47 Masters Mens Kumite Black - Round Robin (each against each)



2019 Karate BC Provincial Championships, CAN

Tatami
5 15:05

Pool
1/1

1  ESPLEY JASCHA (POCO KARATE,CAN) 0 |  CHOI JASON (WEST RIVER,CAN)

2  CHOI JASON (WEST RIVER,CAN) 3

3  ESPLEY JASCHA (POCO KARATE,CAN) 0 |  JOSS ROBERT (KIMNIK SHOTOKAN KARATE ACADEMY,CAN)

4  JOSS ROBERT (KIMNIK SHOTOKAN KARATE ACADEMY,CAN) 7

5  CHOI JASON (WEST RIVER,CAN) 5 |  CHOI JASON (WEST RIVER,CAN)

6  JOSS ROBERT (KIMNIK SHOTOKAN KARATE ACADEMY,CAN) 2



1. CHOI JASON (WEST RIVER,CAN)
2. JOSS ROBERT (KIMNIK SHOTOKAN KARATE ACADEMY,CAN)
3. ESPLEY JASCHA (POCO KARATE,CAN)

Referees:			

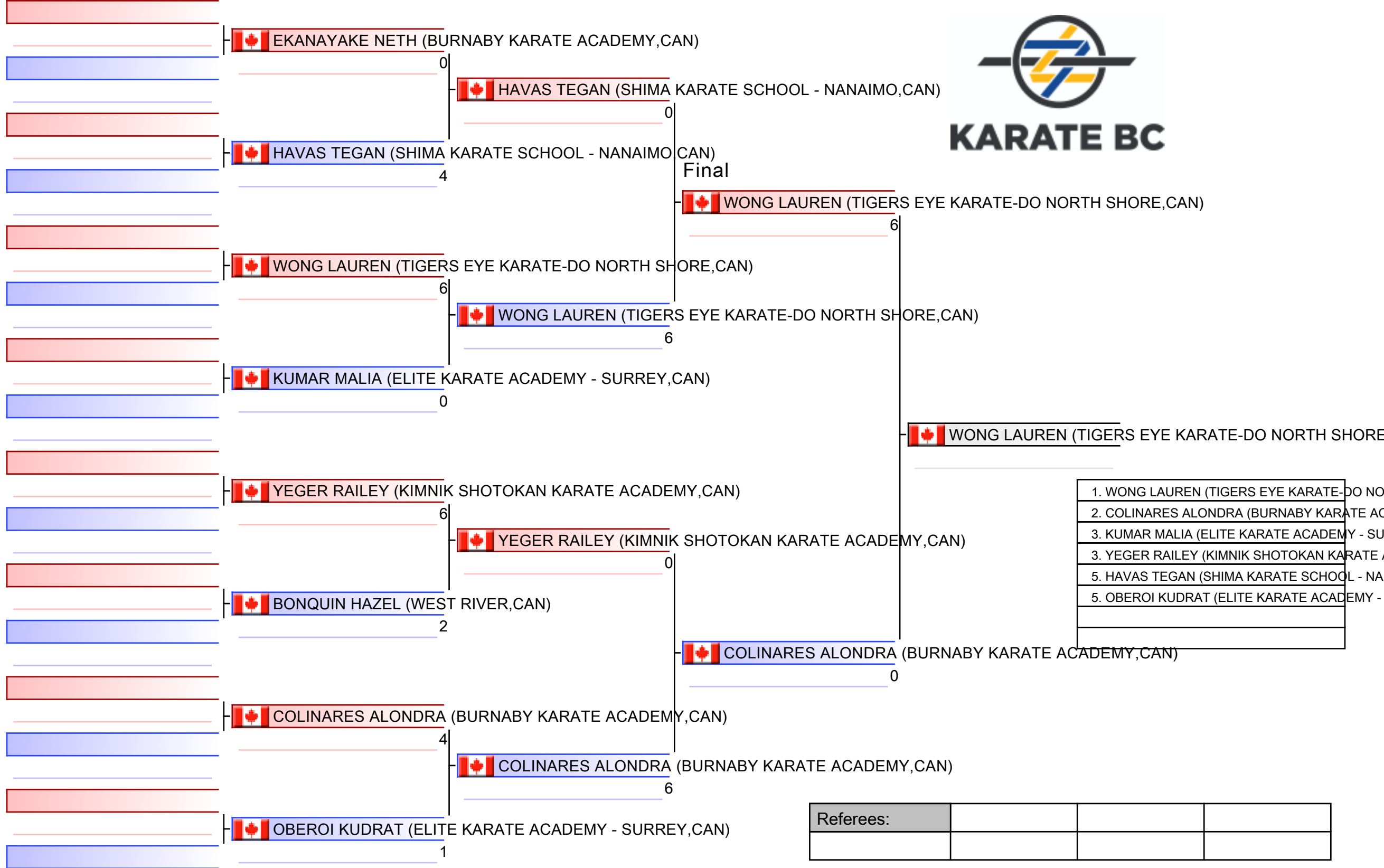

RS-5 Girls 10/11 - Kumite Novice

2019 Karate BC Provincial Championships

Tatami
3 14:00

Pool
1

(c)sportdata GmbH & Co KG 2000-2019(2019-12-04 00:11) -WKF Approved- v 9.8.6 build 2 License: Karate BC (expire 2020-10-12)

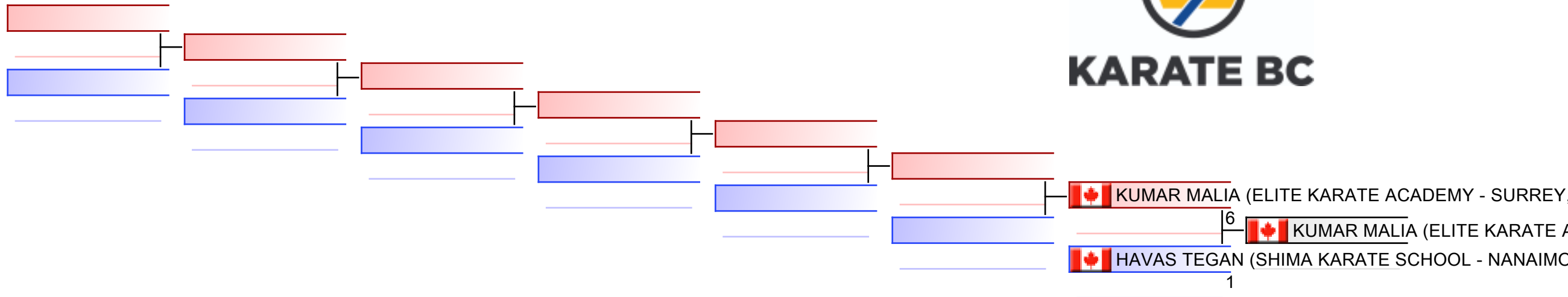

REPECHAGE: (1)

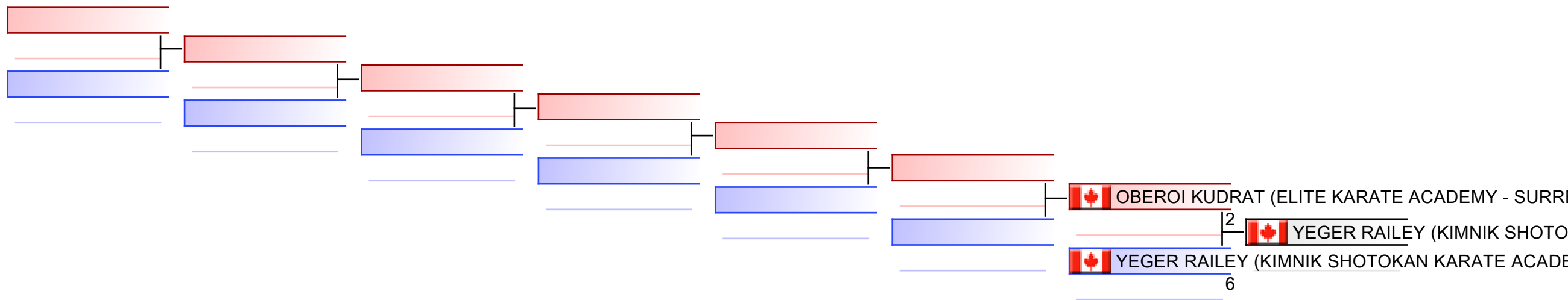

Referees:							
-----------	--	--	--	--	--	--	--

RS-6 Girls 10/11 - Kumite Intermediate

2019 Karate BC Provincial Championships, CAN

Tatami
4 13:25

Pool
1/1

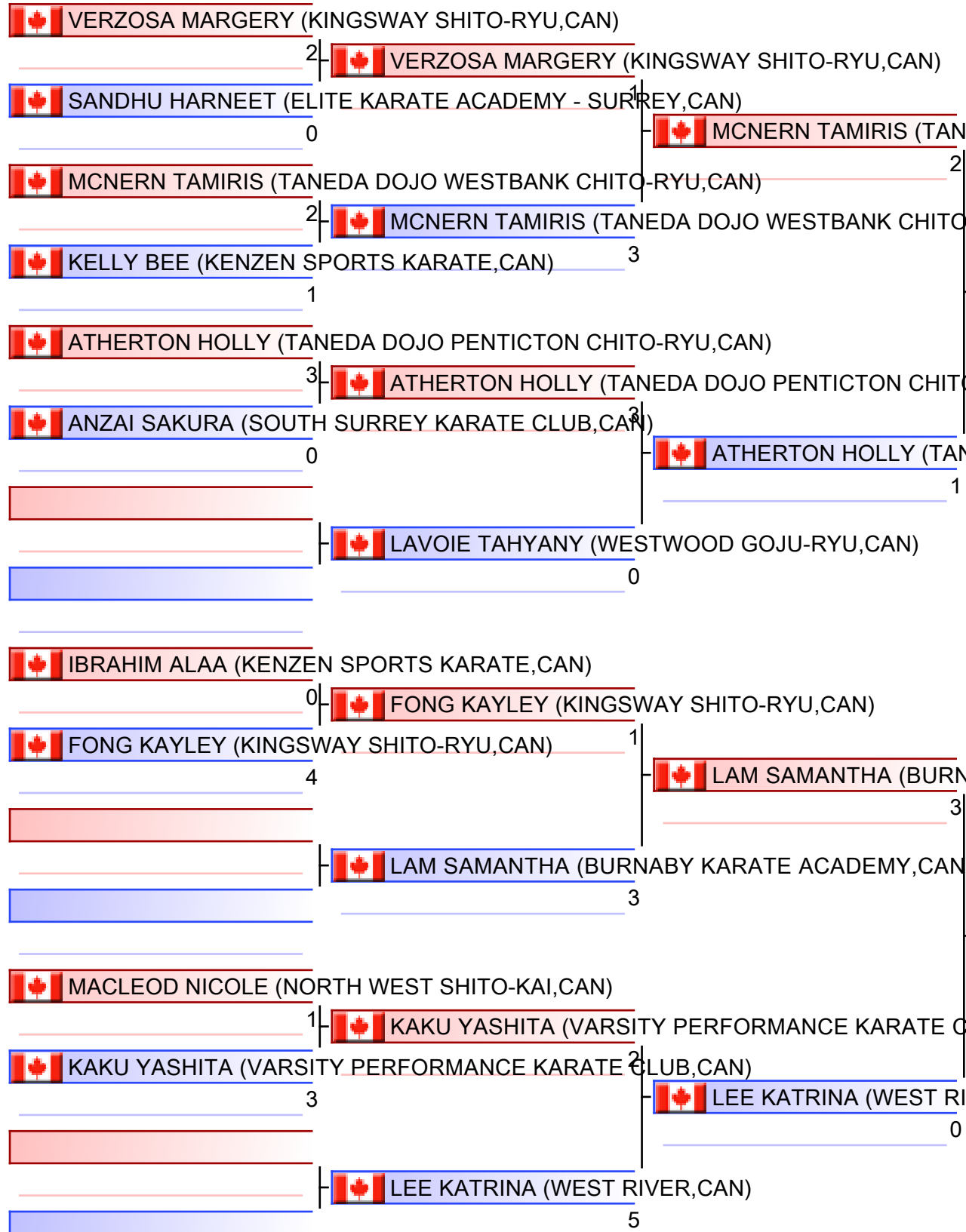

KARATE BC

Final

- | |
|---|
| 1. LAM SAMANTHA (BURNABY KARATE ACADEMY,CAN) |
| 2. MCNERN TAMIRIS (TANEDA DOJO WESTBANK CHITO-RYU,CAN) |
| 3. FONG KAYLEY (KINGSWAY SHITO-RYU,CAN) |
| 3. VERZOSA MARGERY (KINGSWAY SHITO-RYU,CAN) |
| 5. LEE KATRINA (WEST RIVER,CAN) |
| 5. ATHERTON HOLLY (TANEDA DOJO PENTICTON CHITO-RYU,CAN) |
| 7. KELLY BEE (KENZEN SPORTS KARATE,CAN) |

Referees:			

RS-6 Girls 10/11 - Kumite Intermediate

2019 Karate BC Provincial Championships

Tatami
4 14:05

Pool
1

(c)sportdata GmbH & Co KG 2000-2019(2019-12-04 00:11) -WKF Approved- v 9.8.6 build 2 License: Karate BC (expire 2020-10-12)

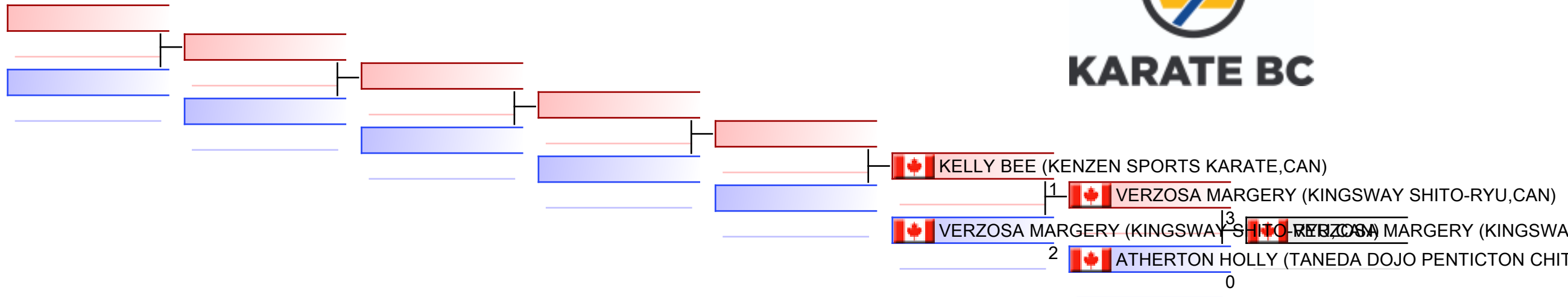

REPECHAGE: (1)

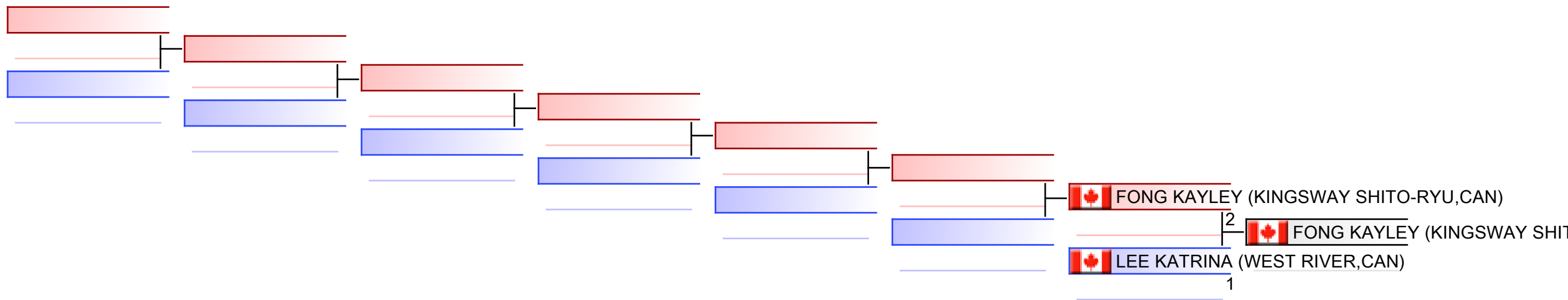

Referees:							
-----------	--	--	--	--	--	--	--



KARATE BC

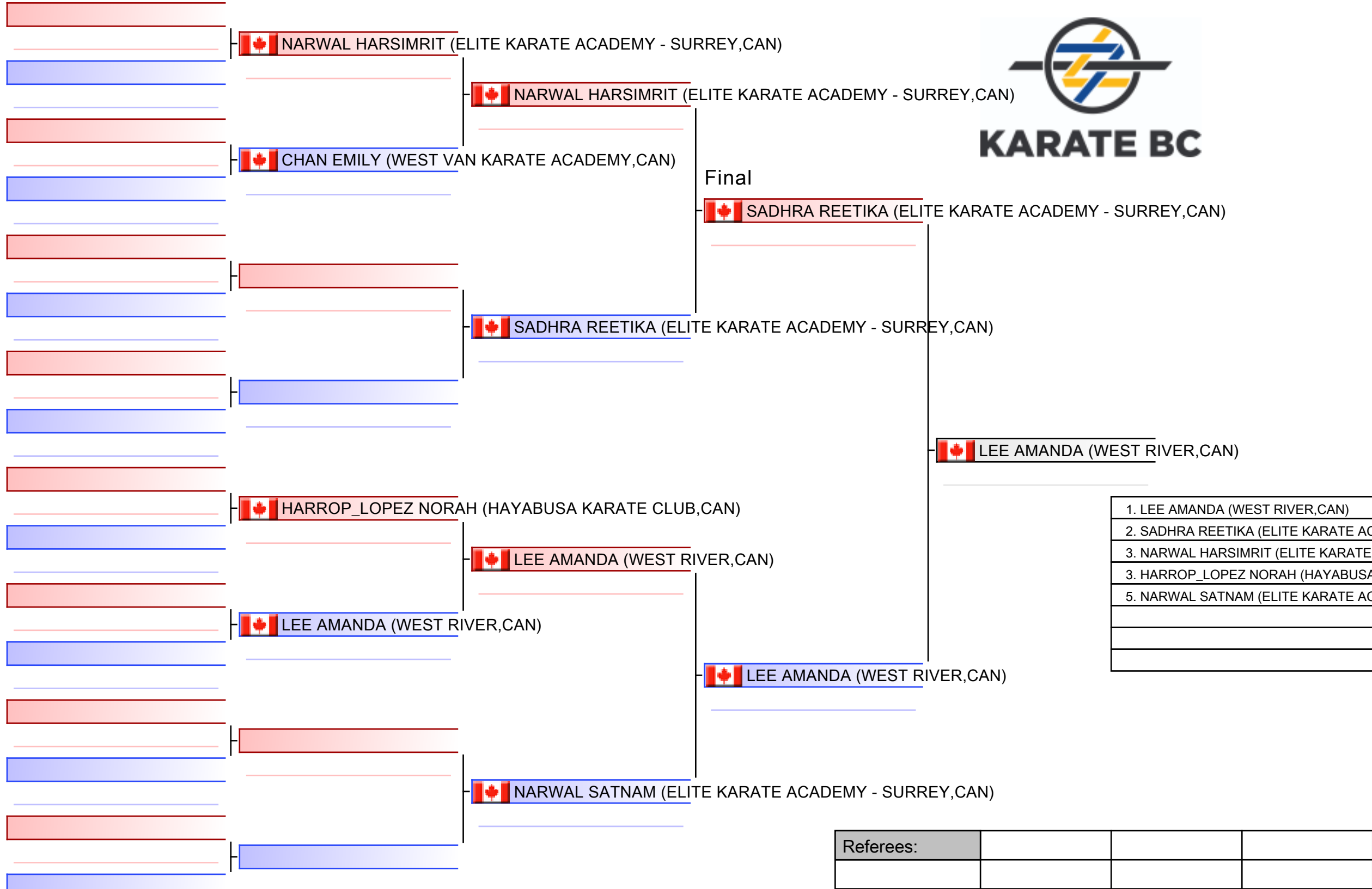

Referees:			

RS-7 Girls 10/11- Kumite Adv/Black

2019 Karate BC Provincial Championships

Tatami
4 14:40

Pool
1

(c)sportdata GmbH & Co KG 2000-2019(2019-12-04 00:11) -WKF Approved- v 9.8.6 build 2 License: Karate BC (expire 2020-10-12)

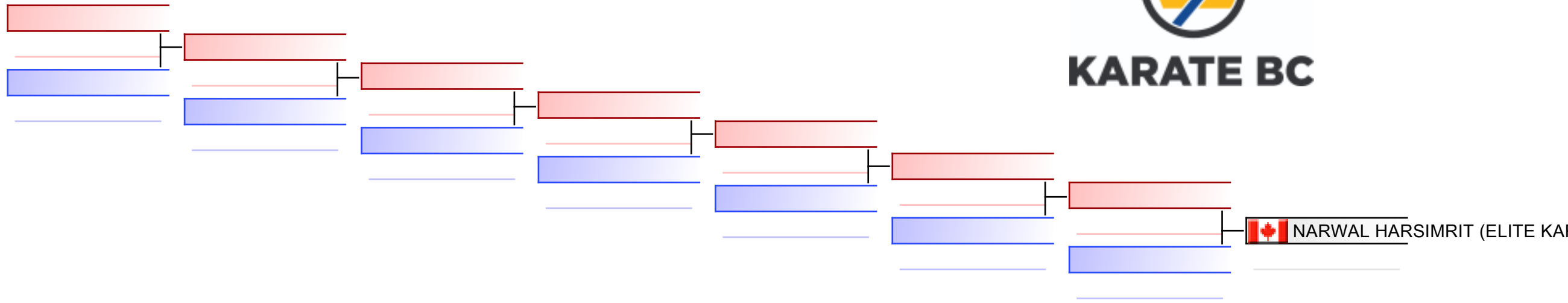

REPECHAGE: (1)

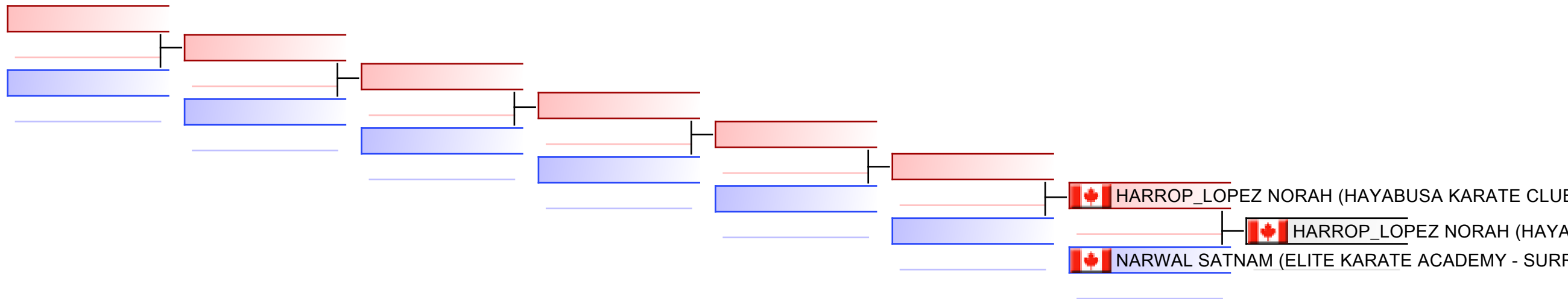

Referees:							
-----------	--	--	--	--	--	--	--

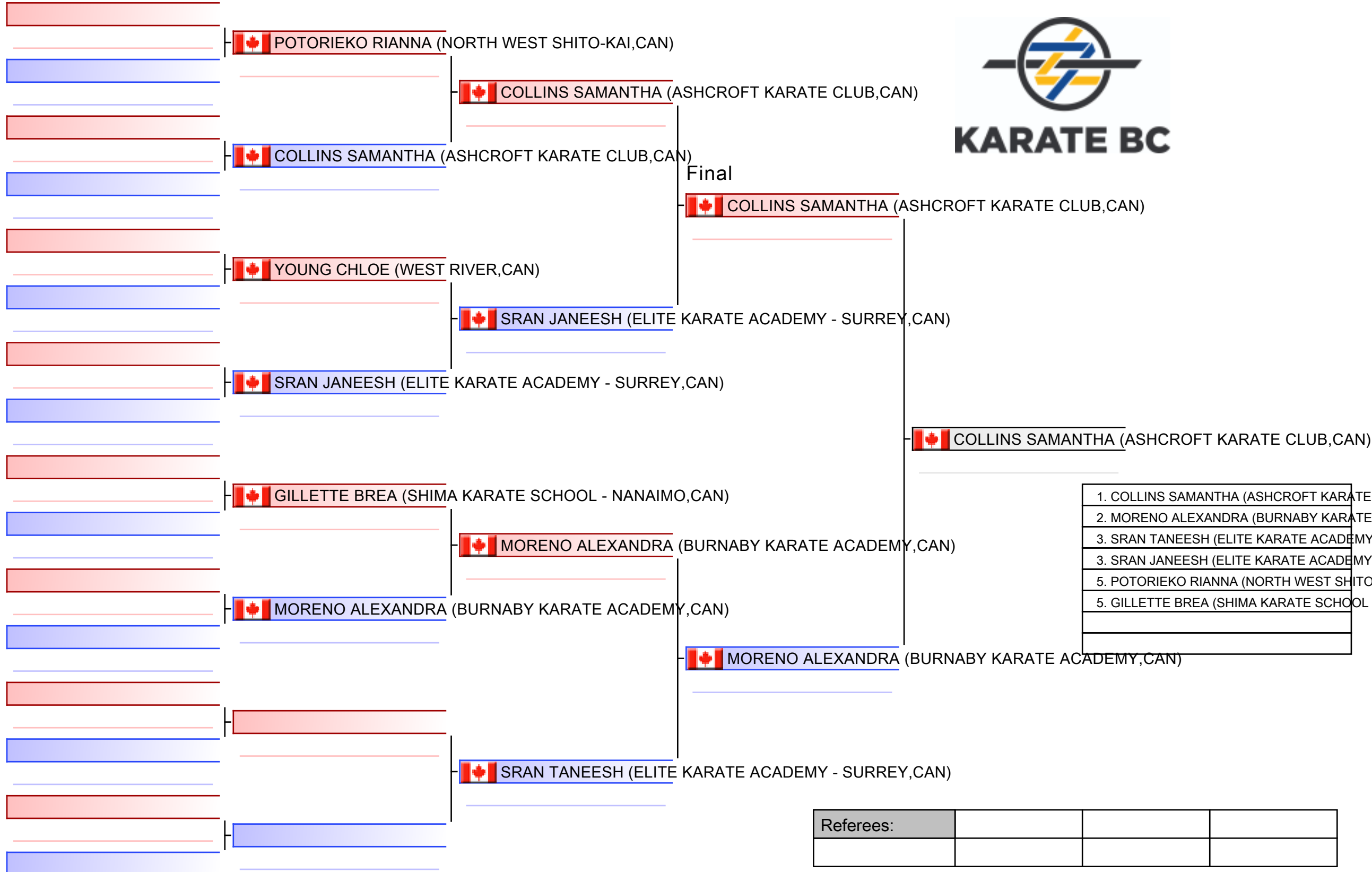

RS-9 Girls 12/13 - Kumite Intermediate

2019 Karate BC Provincial Championships

Tatami
1 15:40

Pool
1

(c)sportdata GmbH & Co KG 2000-2019(2019-12-04 00:11) -WKF Approved- v 9.8.6 build 2 License: Karate BC (expire 2020-10-12)

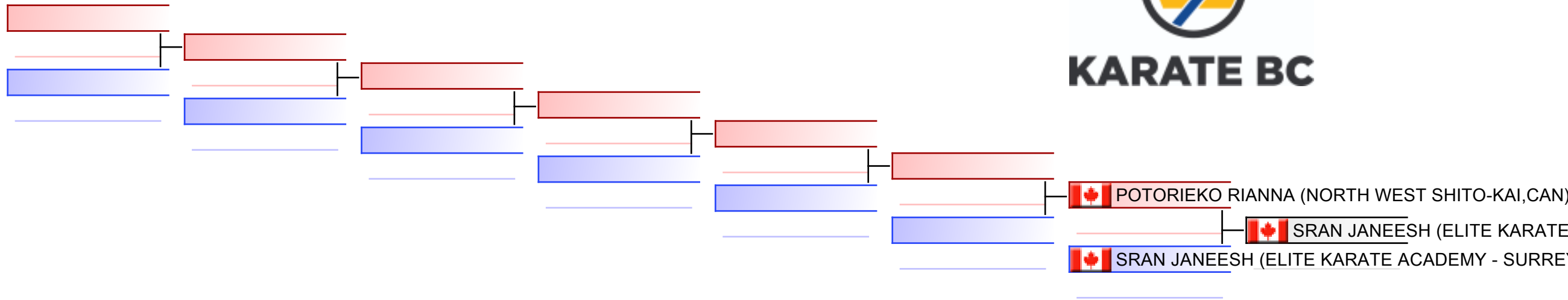

REPECHAGE: (1)

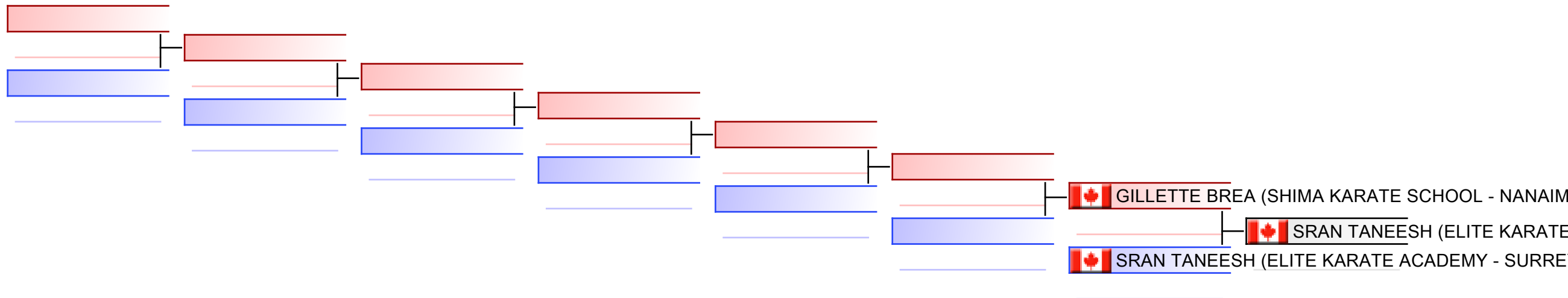

Referees:							
-----------	--	--	--	--	--	--	--



KARATE BC

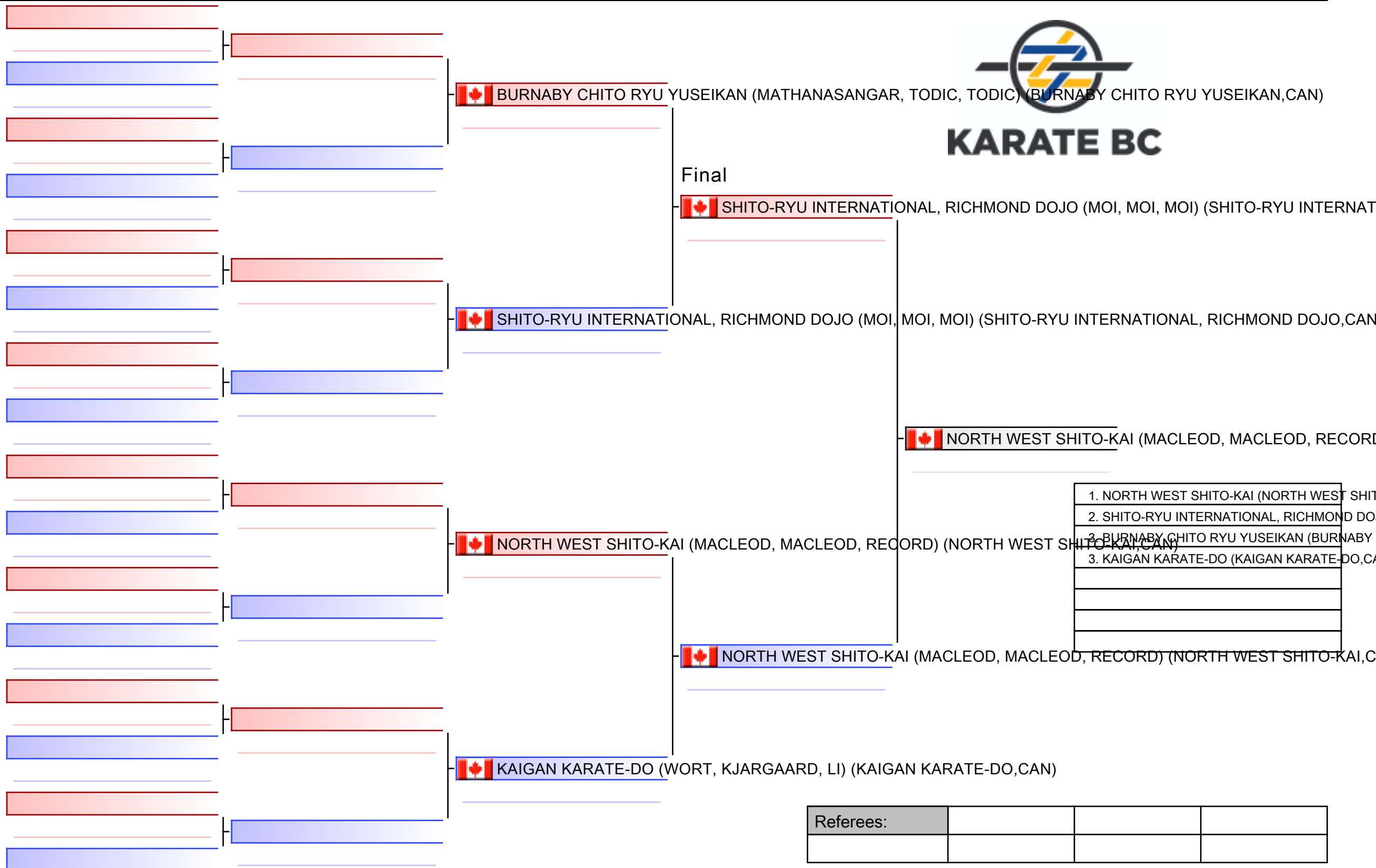

1. NORTH WEST SHITO-KAI (NORTH WEST SHITO-KAI, CAN)
2. SHITO-RYU INTERNATIONAL, RICHMOND DOJO (SHITO-RYU INTERNATIONAL, RICHMOND DOJO, CAN)
3. BURNABY CHITO RYU YUSEIKAN (BURNABY CHITO RYU YUSEIKAN, CAN)
3. KAIGAN KARATE-DO (KAIGAN KARATE-DO, CAN)

Referees:			

TK-1 Team Kata 11 & under Novice to Adv Male/Female

2019 Karate BC Provincial Championships

(c)sportdata GmbH & Co KG 2000-2019(2019-12-04 00:11) -WKF Approved- v 9.8.6 build 2 License: Karate BC (expire 2020-10-12)

Tatami

Pool
1

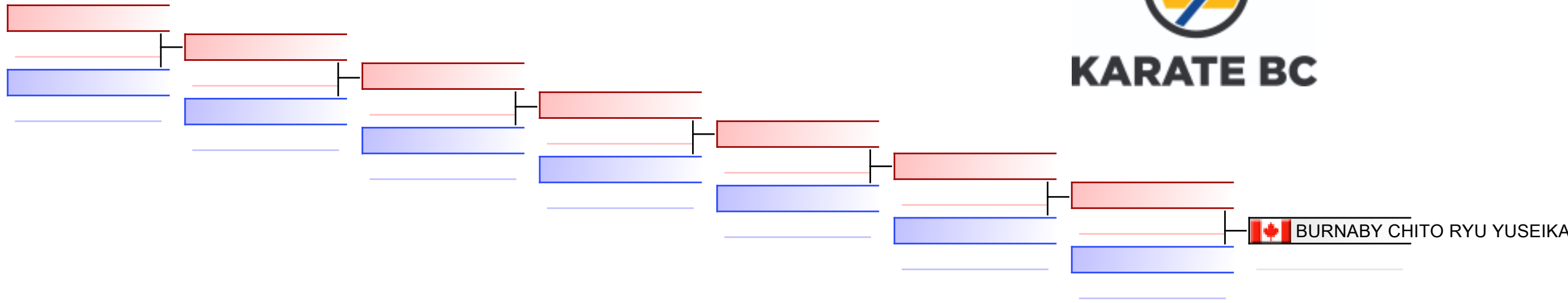

REPECHAGE: (1)

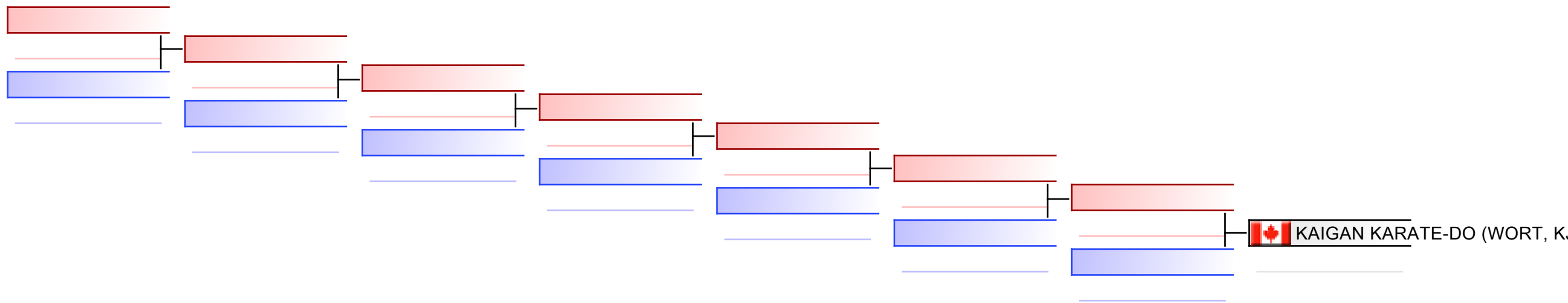









Referees:							
-----------	--	--	--	--	--	--	--

TK-2 Team Kata 12 to 15 Novice to Adv Male/Female - Round Robin (each against each)

2019 Karate BC Provincial Championships, CAN

Tatami
2 09:50

Pool
1/1

- 1  WEST RIVER KARATE (LEE, LIANG, RATTI) (WEST RIVER,CAN)
_____ 3|  WEST RIVER KARATE (LEE, LIANG, RATTI) (WEST RIVER,CAN)
- 2  NORTH WEST SHITO-KAI (CLARK, CLARK, FIELD) (NORTH WEST SHITO-KAI,CAN)
_____ 2
- 3  WEST RIVER KARATE (LEE, LIANG, RATTI) (WEST RIVER,CAN)
_____ 3|  WEST RIVER KARATE (LEE, LIANG, RATTI) (WEST RIVER,CAN)
- 4  SHIMA KARATE SCHOOL - NANAIMO (BAERG, HILDERLEY, HOPEWELL) (SHIMA KARATE SCHOOL - NANAIMO,CAN)
_____ 2
- 5  NORTH WEST SHITO-KAI (CLARK, CLARK, FIELD) (NORTH WEST SHITO-KAI,CAN)
_____ 3|  NORTH WEST SHITO-KAI (CLARK, CLARK, FIELD) (NORTH WEST SHITO-KAI,CAN)
- 6  SHIMA KARATE SCHOOL - NANAIMO (BAERG, HILDERLEY, HOPEWELL) (SHIMA KARATE SCHOOL - NANAIMO,CAN)
_____ 2



1. WEST RIVER KARATE (WEST RIVER,CAN)
2. NORTH WEST SHITO-KAI (NORTH WEST SHITO-KAI,CAN)
3. SHIMA KARATE SCHOOL - NANAIMO (SHIMA KARATE SCHOOL - NANAIMO,CAN)

Referees:			



2019 Karate BC Provincial Championships - 2019-11-30



W-2 Weapons Kata 10 to 13

Novice to Adv Male/Female

Pool 1/1 (4) Tatami 1 09:30

	Competitors	Kata	1	2	3	4	5	6	7	Extra	Total	Rank
1	WORT ETHAN (KAIGAN KARATE,CAN)		8.3	8.1	(7.2)	(8.3)	8.2				24.6	1
2	JILOCA TIMOTHY (KU YU KAI COMPETITION CLUB,CAN)		7.9	(8.2)	(6.8)	8.1	8.1				24.1	3
3	JOHNSTONE KEVIN (SHIMA KARATE SCHOOL - NANAIMO,CAN)		7.7	7.8	(6.0)	7.8	(7.8)				23.3	4
4	HRADEC GABRIEL (WEST RIVER,CAN)		8.2	8.0	(7.0)	(8.4)	8.1				24.3	2

Results

1	WORT ETHAN	KAIGAN KARATE		CANADA
2	HRADEC GABRIEL	WEST RIVER		CANADA
3	JILOCA TIMOTHY	KU YU KAI COMPETITION CLUB		CANADA



2019 Karate BC Provincial Championships - 2019-11-30

W-4 Weapons Kata Adult
Novice to Adv Male/Female

Pool 1/1 (1)

Competitors	Kata	1	2	3	4	5	6	7	Extra	Total	Rank
1 FRANCIS MICHELLE (SHIMA KARATE SCHOOL - NANAIMO, CAN)		(7.6)	7.8	7.8	7.8	(7.8)				23.4	1

Results

1	FRANCIS MICHELLE	SHIMA KARATE SCHOOL - NANAIMO		CANADA
---	------------------	-------------------------------	---	--------



2019 Karate BC Provincial Championships - 2019-11-30

W-6 Weapons Kata Adult
Black Belt Male/Female

Pool 1/1 (2) Tatami 1 09:45

Competitors	Kata	1	2	3	4	5	6	7	Extra	Total	Rank
1 WELCH ADAM (SHIMA KARATE SCHOOL - NANAIMO,CAN)		(7.5)	7.8	(8.0)	7.7	7.8				23.3	2
2 ESPLEY JASCHA (POCO KARATE,CAN)		8.3	(8.2)	(8.6)	8.2	8.2				24.7	1

Results

1	ESPLEY JASCHA	POCO KARATE		CANADA
2	WELCH ADAM	SHIMA KARATE SCHOOL - NANAIMO		CANADA



2019 Karate BC Provincial Championships - 2019-11-30

ETK-1 Female Cadet and Junior Team Kata

R1 G1/1 (1)

Competitors	Kata	1 T	1 A	2 T	2 A	3 T	3 A	4 T	4 A	5 T	5 A	6 T	6 A	7 T	7 A	TEC	ATH	Extra	Total	Rank
1 KIMNIK SHOTOKAN KARATE ACADEMY (MALEKI_RIZI, NAJAFI, TEJA) (KIMNIK SHOTOKAN KARATE ACADEMY.CAN)		(7.6)	(7.6)	(8.0)	(8.0)	7.8	7.6	7.6	7.8	7.8	7.8					16.24	6.96		23.2	1

Results

1 KIMNIK SHOTOKAN KARATE ACADEMY - MALEKI RIZI SETARE - NAJAFI NIKA - TEJA ANEKAH	KIMNIK SHOTOKAN KARATE ACADEMY		CANADA
--	--------------------------------	--	--------